



Shenzhen Growatt New Energy Technology CO.,LTD
No.28 Guangming Road, Shiyao Street, Bao'an District,
Shenzhen, P.R.China

T +86 0755 2747 1942

E service@ginverter.com

W www.ginverter.com



Installation & Operation Manual

list

1 Brief Introduction

- 1.1 Preface
- 1.2 Target Group
- 1.3 Product Description
- 1.4 Safety Instructions

2 Safety

- 2.1 Purpose Use
- 2.2 Safety Measure
- 2.3 Symbols introduction on the
SPH inverter

3 Product Description

- 3.1 Growatt SPH series inverter
- 3.2 Label Explanation
- 3.3 Size and weight
- 3.4 The advantage of the unit of
Growatt SPH

4 Unpacking

5 Installation

- 5.1 Basic installation requirements
- 5.2 Installation requires tools and RJ 45 terminal sequence of the LAN line
- 5.3 Installation Instructions
- 5.4 Grounding connection
- 5.5 SPH System electrical connection

6 Commissioning

- 6.1 Commissioning of SPH
- 6.2 Operation modes
- 6.3 Country setting
- 6.4 Display and button
- 6.5 Communication

7 Start-up and shut down SPH system

- 7.1 Start-up the SPH system
- 7.2 Disconnect the SPH system

8 Attention of the installation environment, maintenance and cleaning

9 Fault removal

10 EU Declaration of Conformity

11 Manufacturer Warranty

12 Decommissioning

- 12.1 Dismantling the energy storage
- 12.2 Packing the SPH inverter
- 12.3 Storing SPH inverter
- 12.4 Disposing of the SPH inverter

13 Product specification

- 13.1 Growatt SPH series energy storage machine product specification
- 13.2 DC input terminal parameter
- 13.3 Torque
- 13.4 Appendix

14 Certificate

15 Contact

1 Brief Introduction

1.1 Preface

This manual will provide the users who use the Growatt SPH Series of GROWATT NEW ENERGY TECHNOLOGY CO.LTD.SHENZHEN(Short for Growatt New Energy as below) with the detailed product information and the installation instructions. Please read this manual carefully and put this manual on some place where is convenient to installation, operation, obtain. Any modifications of Growatt new energy, we will not notify the user.

1.2 Target Group

Growatt SPH inverter must be installed by professional electrical personnel who have obtained the certification of the relevant departments. We have two kinds of energy storage machine for different battery one is for lithium battery and the other is for lead-acid battery, we suggest: customer should decide which kind of energy storage machine you want, Growatt can provide only lithium battery with energy storage machine, customer can choose lead-acid energy storage machine with no battery provide by Growatt while they can buy these battery from market easily. Especially if customer choose energy storage system with lithium battery(which must be provide by Growatt) but used for lead-acid battery or used lead-acid battery for lithium battery model, it will be dangerous. Installer can install energy storage machine of Growatt SPH Series rapidly and troubleshooting, build communication system through read this manual carefully. If you have any questions in the process of installation, you can login in www.growatt.com and leave some message. Or you can call our 24-hour service hotline +86 0755 2747 1942.

1.3 Product Description

Growatt SPH Series is used to store energy generated by the photovoltaic cell panels or energy from grid if it is allowed in the battery, also energy can be sent to power grid through SPH for self consumption or when Grid power is lost, SPH can be used as back up power.

SPH series has six kinds of type:

- Growatt SPH3000
- Growatt SPH3600
- Growatt SPH4000
- Growatt SPH4600
- Growatt SPH5000
- Growatt SPH5600

Note: we describe this series as "SPH" as below.

Note: In different country,we provide different power.Such as in Germany,we can provide SPH3000~SPH4600,but we don't provide SPH5000 and SPH6000.

Overview:

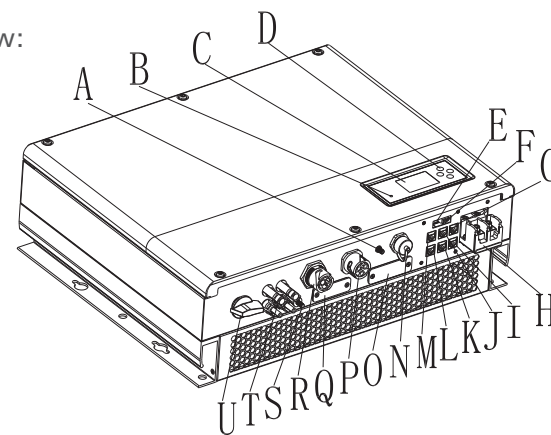

Chart 1.1

Position	Description
A	Antenna
B	LED of status display
C	LCD screen
D	Function button
E	DIP switch (set safety standard)
F	Dry contact
G	RS 485 communication interface of Lithium battery
H	Battery terminal
I	CAN communication interface of Lithium battery
J	RJ45 interface of DRMs(used only in Australia)
K	NTC: Lead-acid temperature sensor terminal
L	RS 485 communication interface of meter
M	CT input terminal
N	USB interface
O	RS 232/Wi-Fi/shinelink cover board
P	AC Grid (on grid connection)

Position	Description
Q	RSD(do not open except by Professional staff)
R	EPS output(off grid connection)
S	Ground point
T	PV input
U	PV switch

1.4 Safety Instructions

- 1.Please be clear which kind of battery system you want, lithium battery system or lead-acid battery system, if you choose the wrong system, SPH can't work normally.
- 2.Please read this manual carefully before the installation, the company has the right not to quality assurance, if not according to the instructions of this manual for installation and cause equipment damage.
- 3.All the operation and connection please professional electrical or mechanical engineer.
- 4.During installation, please don't touch the other parts within the box.
- 5.All the electrical installation must comply with the local electrical safety standards.
- 6.If equipments needs to maintain, please contact with local specify system installation and maintenance personnel.
- 7.Use the equipment to combined to grid needs to obtain the permission of local power supply department.
- 8.When install PV modules in the daytime, please turn off the PV switch, otherwise it will be dangerous as high terminal voltage of modules in the sunshine.

2.1 Purpose Use

The system chart of SPH:

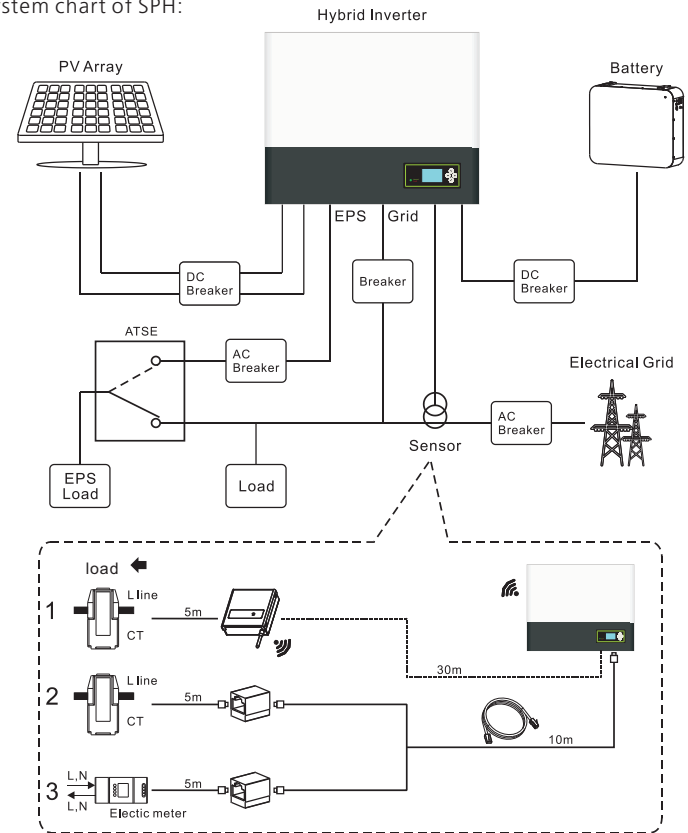

Chart 2.1

As shown above, a complete grid-connected system of SPH consists of PV modules, SPH inverter, battery, utility grid and other components.

Attention:

Battery installation requirement

As the system refer to battery use, we must make sure ventilation of the service environment and temperature control in order to prevent the danger of battery explosion, battery recommended installation environment must be strictly in accordance with the specification, if the specification is IP20 environment, the pollution degree of the unit is PD2, meanwhile the temperature should be control in the 0-40°C of indoor ventilation and the humidity should be 5%-85%. If the chosen PV modules needs to positive or negative ground connection, please contact with Growatt for technical support before installation.

PV modules Capacitive Discharge Currents

PV modules with large capacities relative to earth, such as thin-film PV modules with cells on a metallic substrate, may only be used if their coupling capacity does not exceed 470nF. During feed-in operation, a leakage current flows from the cells to earth, the size of which depends on the manner in which the PV modules are installed (e.g. foil on metal roof) and on the weather (rain, snow). This "normal" leakage current may not exceed 50mA due to the fact that the inverter would otherwise automatically disconnect from the electricity grid as a protective measure.

2.2 Safety Measure



Risk of high voltage !

- Relevant operation for professional personnel.
- Please notice children, disabled, laypeople do not close
- Supervise and make sure children don't play near the installation position of energy storage machine



Risk of burns on the parts shell of SPH inverter !

During the work, cover, shell around, radiator is likely to be hot.



SPH inverter exists radiation maybe affect health !









Don't stay a long time within 20cm from SPH inverter.



SPH inverter ground connection

Please ensure SPH inverter ground connection is reliable for make sure people's safety.



2.3 Symbols introduction on the SPH inverter

Symbol	Description
	Caution: Risk of electrical shock!
	Caution : Hot surface
	Caution: Risk of danger
	Danger to life due to high voltage in SPH There is residual voltage in SPH, SPH requires 5 minutes to discharge. Please wait 5 minutes before you open the upper lid or the DC lid.
	Protective conductor terminal
	Direct Current(DC)
	Alternating Current(AC)
	The inverter complies with the requirements of the applicable CE guidelines
	Refer to the operating instructions.

3 Product Description

3.1 Growatt SPH series inverter

Marks of SPH

Mark	Description	Explanation	
	Push-button	Operation of display screen and set system	
	Status symbol of SPH	Green light on	SPH run normally
		Red light on	Fault state
		Green light blinking	1.Alarm state
		Red light blinking	2.Software updating

3.2 Label Explanation

Label contains the following information: for example SPH6000 shows as below:

Growatt

Model Name:
Growatt SPH6000

PV input data:

Max. input power:
4000W/4000W

PV input voltage range:
120V~550Vdc

Max. PV input voltage:
550Vdc

Number of input strings:
2/1

Max. PV short current:
12A

Max. input current per string:
12A

AC output data:

Max. AC apparent power:
6000VA

Max. AC output current:
27A

AC Nominal voltage:
230V , 50/60Hz

Power Factor:
0.8leading~0.8lagging

Stand alone:

Rated AC output power:
3000W

Rated AC output voltage:
230V , 50/60Hz

Battery data:

Battery voltage range:
42~59Vdc

Max. charging and discharging current:
66A

Max. charging and discharging power:
3000W

Type of battery:
Lithium / Lead-acid

Environment:



Operating temperature range:
-25°C ~ +60°C

Degree of protection:
IP65

Protective class:
Class I

Certificates and approvals

G99, G100, AS4777, CEI 0-21, CE, IEC62109, AS/NZS 3100, VDE0126-1-1, VDE-AR-N410 5, EN50438, VFR, MEA, PEA, IEC61727, IEC62116



Made in China

Description of label:

The type of product	Growatt SPH6000
PV input data	
Max input power	4000W/4000W
PV input range	120-550Vdc
Max. PV input voltage	550Vdc
Number of input strings	2/1
Max input current per string	12A
Max PV short current	12A
AC output data	
Max AC apparent power	6000VA
Max AC output current	27A
AC nominal voltage	230V,50/60Hz
Power factor	0.8 leading~0.8 lagging
Stand alone	
Rated AC output power	3000W
Rated output voltage	230V,50/60Hz
Battery data	
Battery voltage range	42-59Vdc
Max charge and discharge current of battery	66A
Type of battery	Lead battery and lithium battery
Environment	
Operating temperature range	-25°C~+60°C
Degree of protection	IP 65
Certificates and approvals	G99,G100,AS4777,CEI 0-21,CE,IEC62109, AS/NZS 3100,VDE 0126-1-1,VDE-AR-N4105,EN50438,VFR,MEA,PEA,IEC61727, IEC62116

3.3 Size and weight

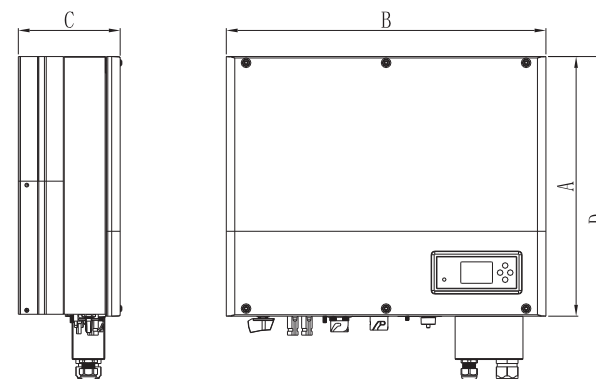

Chart 3. 1

	A(mm)	B(mm)	C(mm)	weight (kg)
Growatt SPH	450	565	180	27

3.4 The advantage of the unit of Growatt SPH

Features below:

- All in one design. Can improve self consumption, back up and also pinch the valley.
- Smart management,work mode can be set.
- Safe battery used.
- Easy installation.
- Two mpp tracker input.

4 Unpacking

Installation 5

Please check whether external damage to the goods before unpacking.
After unpacking, please check whether the unit damage or missing parts, if it is happen, please contact with supplier.

Growatt SPH series and accessories as follows:

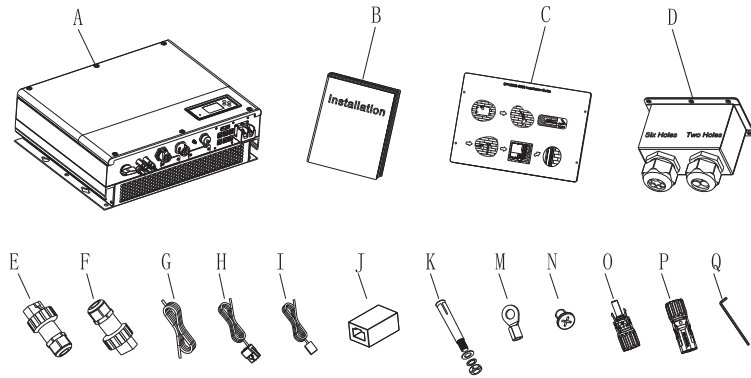

Chart 4.1

Item	Number	Description
A	1	SPH inverter
B	1	User Manual
C	1	Paper board(installation guide)
D	1	Waterproof cover
E	1	AC Grid connector(Austrialian machine terminal is different)
F	1	EPS output connector
G	1	Communication cable
H	1	Current sensor
I	1	Lead-acid battery temperature sensor
J	1	RJ45 connector
K	4	M6 setscrew
M	2	Battery power terminal
N	6	Screw
O/P	2/2	MC4 connector
Q	1	Hex screwdriver

5.1 Basic installation requirements

- A. The installation location must be suitable for SPH's weight for a long period time
- B. The installation location must conforms with dimension of SPH
- C. Do not install the unit on structures constructed of flammable or thermo labile materials
- D. The ingress Protection rate is IP65 and the pollution degree is Pd2. and SPH can't be enclosed. Please refer to the below:

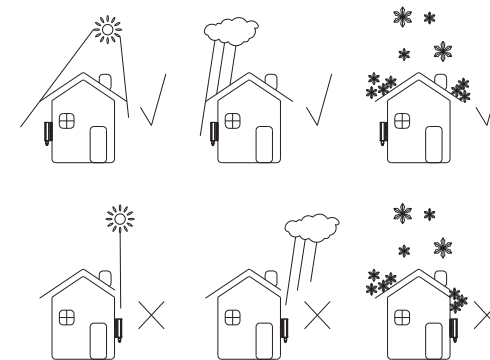

Chart 5.1

- E. Battery installation option is not far away from the position of SPH, the length between SPH and battery should not be more than 1.5m.
- F. The ambient temperature should be -25°C ~ 60 °C
- G. SPH can be installed in vertical or lean back on plane, please refer to the below

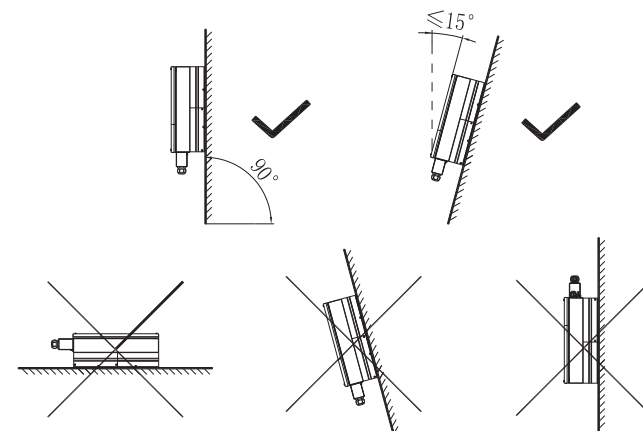

Chart 5.2

H. Installation position shall not prevent access to the disconnection means.
 I. In order to ensure machine can run normally and easy to operate, please pay attention to provide adequate space for SPH, please refer to below:

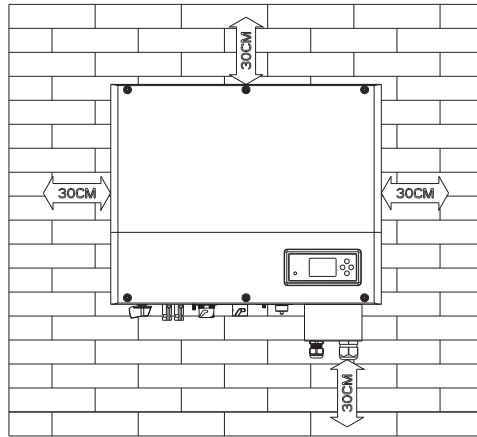

Chart 5.3

- J. Do not install the machine near television antenna or any other antennas and antenna cables
- K. Don't install the machine in the living area
- L. Be sure that the machine is out of the children's reach
- M. Taking the battery fixing space into account, about the dimensions please reference user manual
- N. The inflammable and explosive dangerous goods must not be placed around battery in case of cause serious danger.

5.2 Installation requires tools and RJ 45 terminal sequence of the LAN line

When installing, we need to use tools as follow, prepare the follow tools before installing :



Chart 5.4

No	Description
1	Press the RJ45 terminal
2	Press battery terminal connector
3	Disconnect PV terminal
4	Unscrew nut
5	Unscrew screw
6	Knock explosion bolt
7	Drill holes on the wall

LAN line RJ45 sequence as follow :

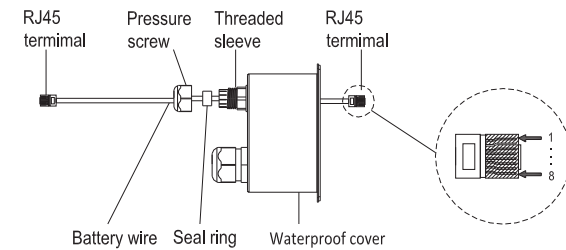

Chart 5.5



Chart 5.6

LAN line 1-8 colors as below:

PIN	1	2	3	4	5	6	7	8
Color	White orange	Orange	White green	Blue	White blue	Green	White brown	Brown

5.3 Installation Instructions

5.3.1 Attention Layout (length of sensors consider)

There're three types of sensors for use with Growatt SPH. One is wired current sensor, one is meter sensor, or SP-CT, if you choose wired sensor or meter. Before installing you should know something that as below:

The cable of wired sensor and meter is suggested not longer than 15m. So you need to consider the length between SPH with combiner box for the sensor should be installed in the live line. And if you installed SP-CT for sensor, distance recommended not more than 30 meters.

The installation layout of energy storage machine at home as following :

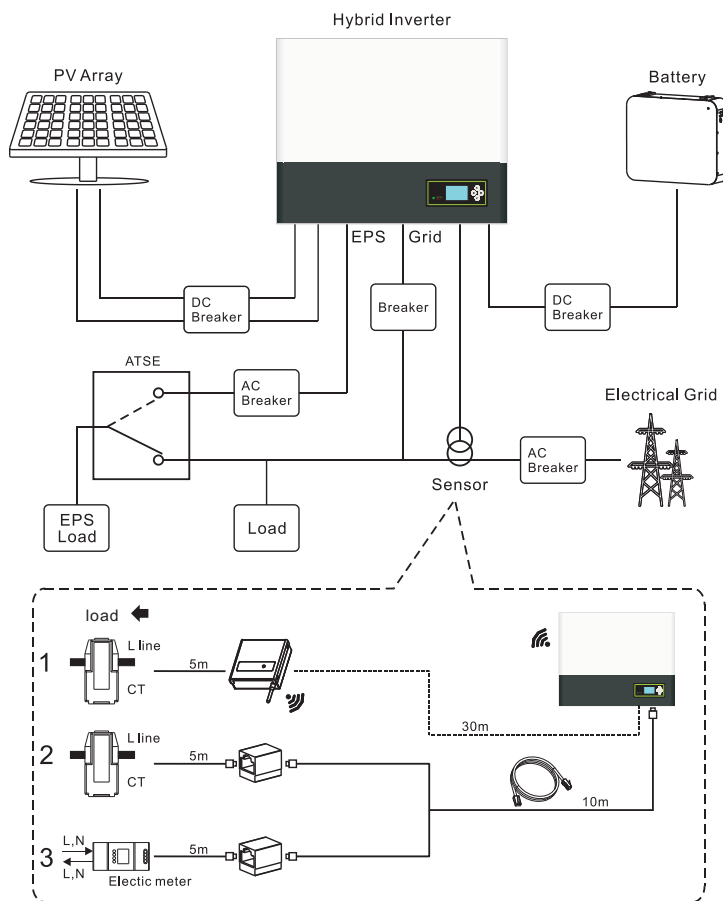
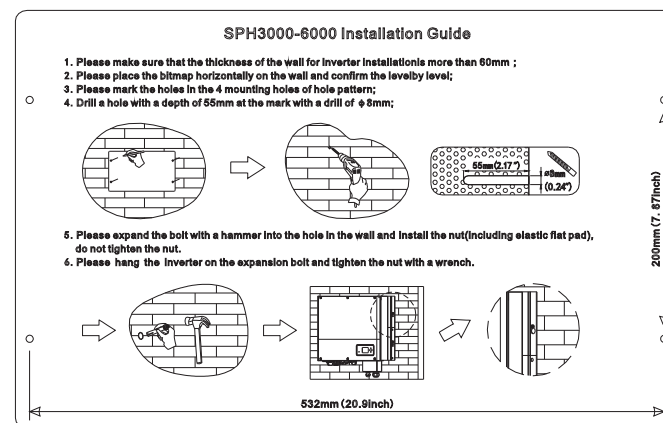

Chart 5.7

5.3.2 Installation of SPH

1. Project the machine's probably size on the wall; The thickness of wall for SPH must be not less than 60mm.
2. Make sure the drill position, use paper board (installation guide), put the paper board cling to the wall, make sure the top edge of paper board is level (As the chart 5.8a below).
3. Mark four points at the wall via the hole of the paper board, then remove the paper board.
4. Drill four $\Phi 8$ holes at the mark point, the depth is not less than 55mm.
5. Knock four explosion bolt into $\Phi 8$ holes (As the chart 5.8b below).
6. Hang the energy storage machine on the four setscrews (As the chart 5.8c below).
7. Lock the nut of setscrew (As the chart 5.8d below).
8. The whole installation has finished.



a)

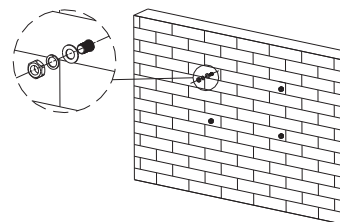

b)

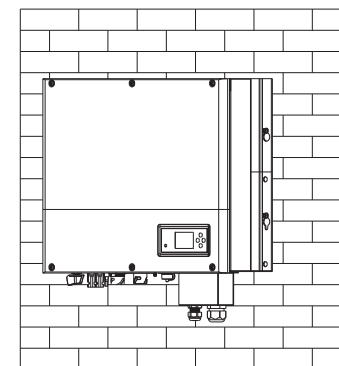

c)

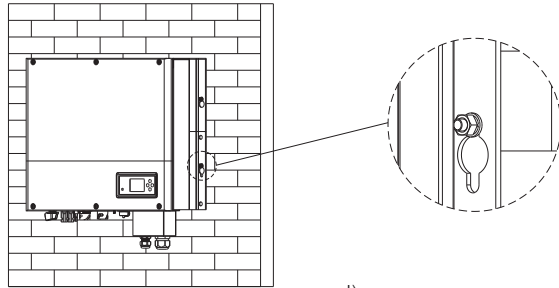

d)
Chart 5.8

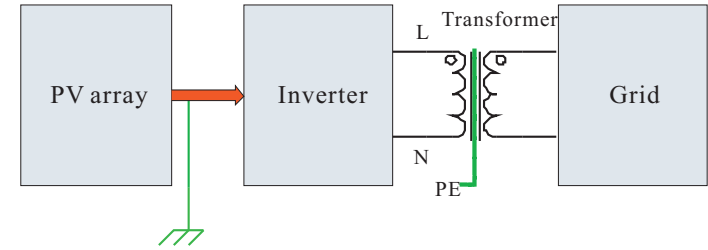

Chart 5.10

5.4 Grounding connection

SPH must be grounded by cable, the grounding point is showed as follow, and the minimum grounding cable wire is AWG10.

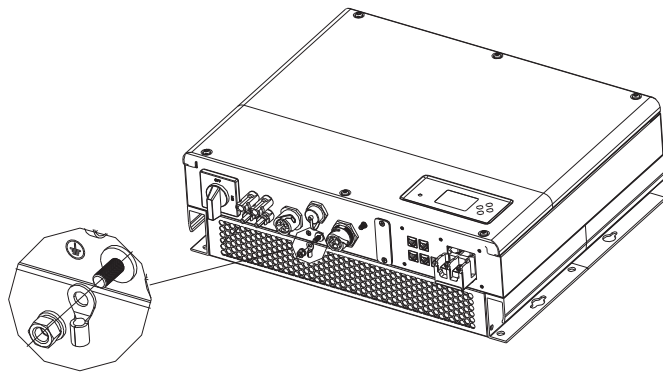

Chart 5.9

PV Array Grounding

Grounding conductor of PV panel brackets must be firmly connected to earth at PV array side and inverter side and SP side. The sectional area of grounding conductor should be equal to the sectional area of DC grounding conductor. The minimum wire is AWG10.

DC Grounding

Select the DC Grounding mode according to the local standard and use the PV grounding terminal box and DC Grounding wires of the same specification.

Grounding Device

If the positive pole or the negative pole of PV array needs to be grounded in the PV system, the inverter output should be insulated by Isolation Transformer. Isolation transformer must conform to IEC62109-1,-2 standard.

Connection as below:

5.5 SPH System electrical connection

Decisive Voltage Class (DVC) indicated for ports

Port Name	Class
AC	C
DC	C
DRMS	A
RS485&RS232	A

5.5.1 Connection of PV terminal



WARNING

The inverter shall be used with IEC 61730 Class A rating PV module.
Please use the same brand male and female PV connectors.

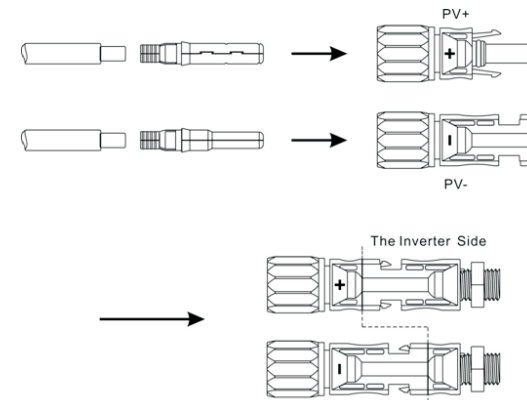

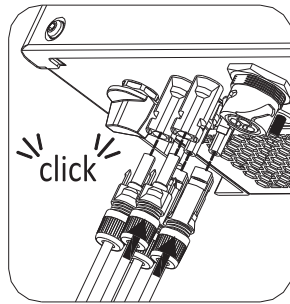

Chart 5.11

Similar to the traditional inverter connecting, the input of PV panel energy can be realized by using MC4 PV terminal, the detail steps are as follows :

1. Turn off PV switch.
2. Insert PV panel positive and negative cables into MC4 terminal, then connect positive pole(+) of connection cable to positive pole(+) of PV input connector, connect negative pole(-) of connection cable to negative pole(-) of PV input connector, please pay attention to PV input voltage and current within permission Limit:

Max PV voltage : 550V (consider the lowest temperature)

Max PV input current: 12A

Max PV input power per string: 4000W.

- Remark:
1. We suggest you use the cable $\geq 4\text{mm}^2/12\text{ AWG}$ to connect.
 2. Please do not connect to DC source!

5.5.2 Connection of AC terminal and off grid terminal

SPH has a grid output terminal and off grid out terminal, look down on the SPH from the front, the terminal on the left (on grid) is grid outlet for connecting grid, the terminal on the right is an emergency power outlet for connecting critical load.

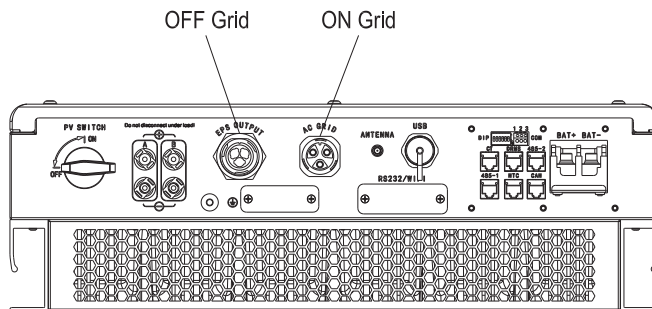

Chart 5.12

Wire suggest length

Conductor cross section	Max cable length					
	Growatt SPH3000	Growatt SPH3600	Growatt SPH4000	Growatt SPH4500	Growatt SPH5000	Growatt SPH6000
5.2mm ² 10AWG	40m	33m	28m	26m	25m	23m
6.6mm ² 9AWG	50m	42m	36m	33m	32m	29m

AC output terminal and EPS output terminal connection steps as follow (Except for the Australian machine):

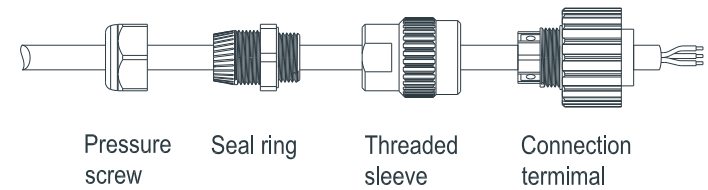

Chart 5.13

Step1: Uninstall the AC terminal as above chart.

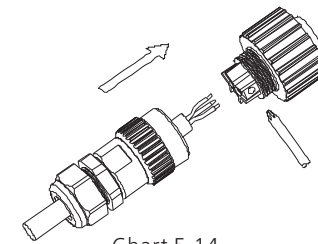

Chart 5.14

Step 2: Thread cables through pressure screw, seal ring, threaded sleeve in sequence, insert cables into connection terminal according to polarities indicates on it and tighten the screws.

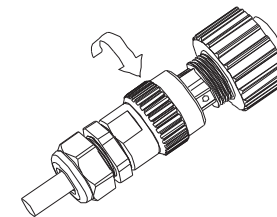

Chart 5.15

Step 3: Push threaded sleeve on to connection terminal until both are locked tightly

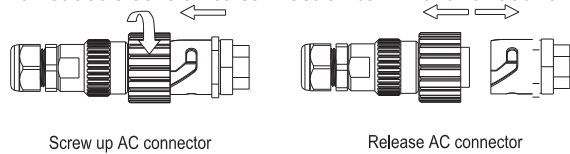

Chart 5.16

Note:The following diagram shows the AC output terminal of the Australian machine connection steps are as follows, EPS output terminal connection steps consistent with the above steps.

AC output terminal connection steps as follow:

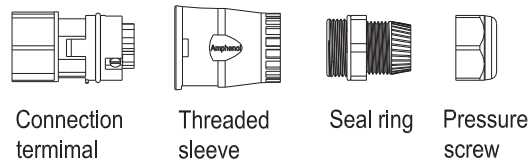

chart 5.17

Step 1: Uninstall the AC terminal as above chart .

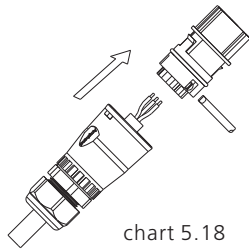

chart 5.18

Step 2.Thread cables through pressure screw, seal ring, threaded sleeve in sequence, insert cables into connection terminal according to polarities indicates on it and tighten the screws.

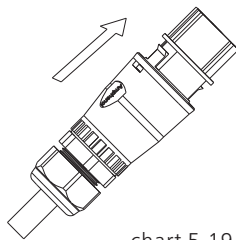
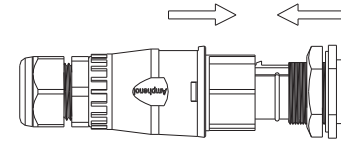

chart 5.19

Step 3: Push threaded sleeve on to connection terminal until both are locked tightly.



Screw up AC connector

chart 5.20

Step 4: Align the bayonet of the AC output terminal to the slot of thread sleeve, Plug the socket into AC output terminal.

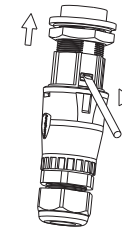

Release AC connector

chart 5.21

Step 5:To remove the AC output terminal , press the bayonet out of the slot with a small screwdriver and pull it out.

The recommended wiring diagram is as follows:

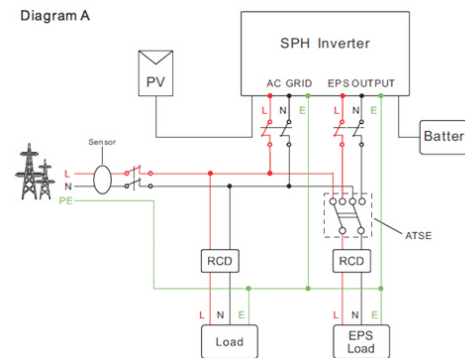

Chart 5.22

Note:
This diagram is an example for grid system without special requirement on electrical wiring connection.

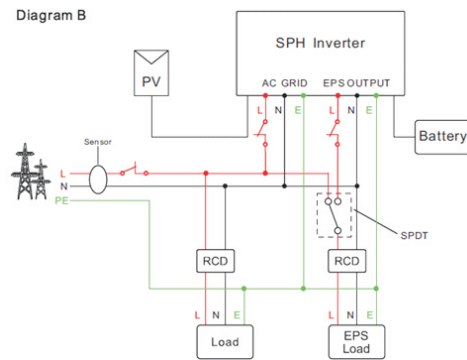

Chart 5.23

Note:
This diagram is an example for Australian and New Zealand grid system where neutral line can't be switched.

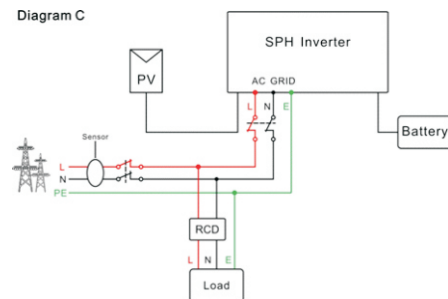

Chart 5.24

Note:
This diagram is an example for customer who only want to use the on grid system .



Notice:

- 1.If you want to use on grid only, please refer to Diagram C connect with AC grid and float EPS OUTPUT.If neutral line can't be switched, please only swith live line.
- 2.If you have no battery now, you can also float BAT terminal, and this hybrid inverter will only work like a PV inverter.
- 3.If you want to use both on grid power and backup power ,please refer to Diagram A and Diagram B. connect with AC grid and EPS OUTPUT like the chart show.
- 4.On grid terminal and off grid terminal can't directly connect together.
- 5.Off Grid terminal can't connect to grid.
- 6.If you want to use on grid and off grid, you can use ATS (automatic transfer switch) like Diagram A and Diagram B before or ask Growatt for help.
- 7.The first start of system needs grid power.

5.5.3 Connection of battery terminal

Install battery steps are as follows:

- 1.Unscrew the swivel nut from the cable gland.
- 2.Thread the swivel nut over the battery cable.
- 3.Press the cable support sleeve out of the cable gland.
- 4.Remove the filler plug from the cable support sleeve.
- 5.Route the network cable through an opening in the cable support sleeve.
- 6.Thread the network cable through the cable gland.
- 7.Thread cables into connection terminal, then press the terminal by relevant tools and make sure battery cables are firmly (Growatt lithium battery contains a battery cable in the original packing).
- 8.Connect positive pole (+) of battery cable to battery positive terminal (+) of the inverter, connect negative pole (-) of battery cable to battery negative terminal (-).
- 9.Continue to install other cables.

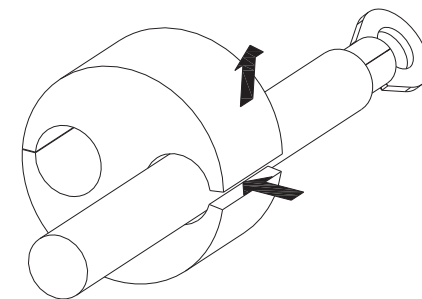

Chart 5.25

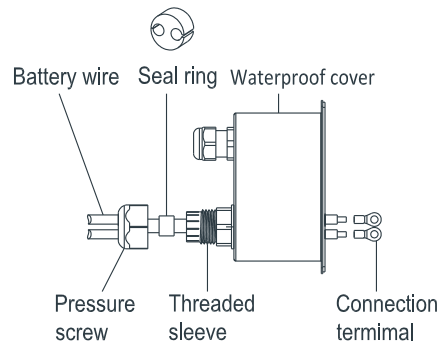

Chart 5.26

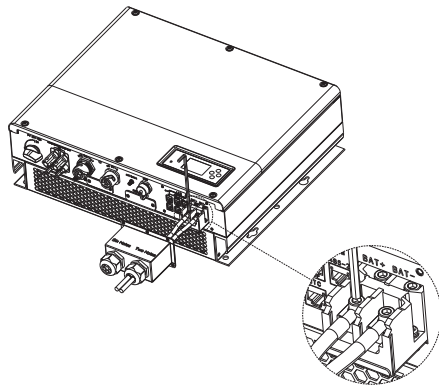

Chart 5.27

Note: We suggest the distance between battery and SPH no longer than 1.5m, and the power line area must be larger than 5 AWG.

5.5.4 Connection of CT terminal

There is a CT in SPH inverter monitoring the power consumption situation of residential users, the CT terminal connection steps are as follows:

1. Unscrew the swivel nut from the cable gland.
2. Thread the swivel nut over the "CT" cable.
3. Press the cable support sleeve out of the cable gland.
4. Remove the filler plug from the cable support sleeve.
5. Route the "CT" cable through an opening in the cable support sleeve.
6. Thread the "CT" cable through the cable gland.
7. Insert the RJ45 plug of the network cable into the "CT" pin connector on the inverter until it snaps into place.
8. If no other cables need to be installed, lock the waterproof cover to the inverter with screws.
9. Screw the swivel nut onto the waterproof cover.

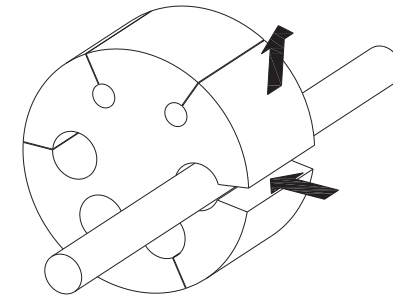

Chart 5.28

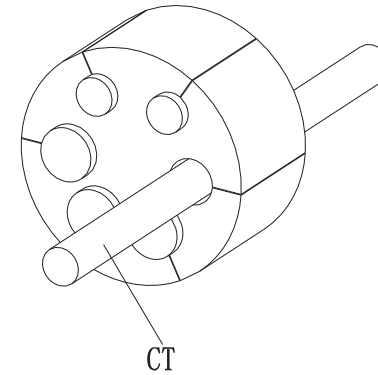

Chart 5.29

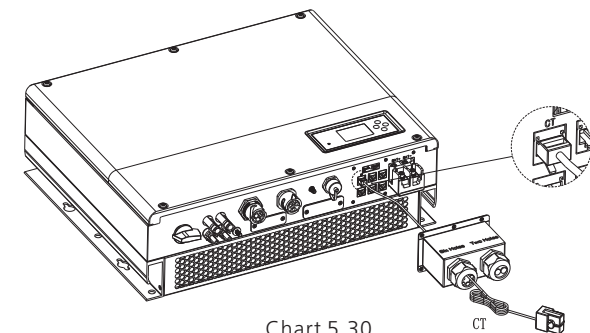

Chart 5.30

Note:

1. The meter and CT can't be installed at same time, please set the sensor model when selecting CT or electricity meter, please refer to section 6.3.3 for details.
2. If the cable such as "CT" cable is not used, please do not remove the filler plug from the cable support sleeve.

Remark:

CT wire (5m in length) specification: RJ45, standard LAN line (one end with 8P modular plug, the other connected with transformer). But if the length is not enough, customer can add cable, so the length can be increased to 15m max, the operation is as follow chart:

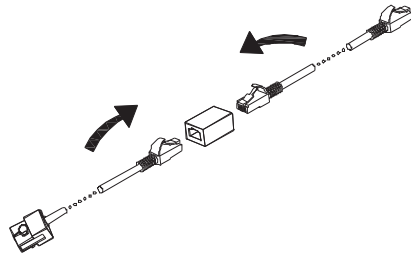

Chart 5.31

During the actual operation, please pay attention to the installation of current transformer as the diagram shows below:

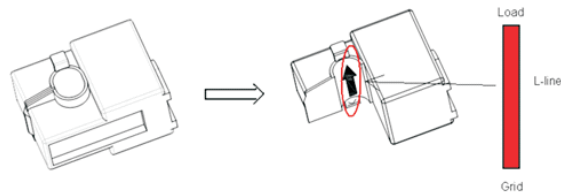

Chart 5.32

As illustrated above, open the current transformer and you can see an arrow labeled on it indicating the direction of current. Put the live wire among the under-detection wires onto the current transformer. After latching the current transformer, the installation has been finished

Notice:

The direction (from K to L) of the arrow on the current transformer is corresponding to the direction of the current in live wire from Grid to Load. Sensor needs to be placed in the power distribution cabinet.

5.5.5 Connection of meter terminal

When customer needs to use meter to monitor the energy flow, the meter terminal connection steps are as follows:

1. Reference 5.2, make LAN cables with RJ45 terminal.
2. Thread the swivel nut over the LAN cable.
3. Press the cable support sleeve out of the cable gland.
4. Remove the filler plug from the cable support sleeve.
5. Route the LAN cable through an opening in the cable support sleeve.
6. Thread the LAN cable through the cable gland.
7. Insert the RJ45 plug of the network cable into the "485-1" pin connector on the inverter until it snaps into place.

8.If no other cables need to be installed, lock the waterproof cover to the inverter with screws.

9.Screw the swivel nut onto the waterproof cover.

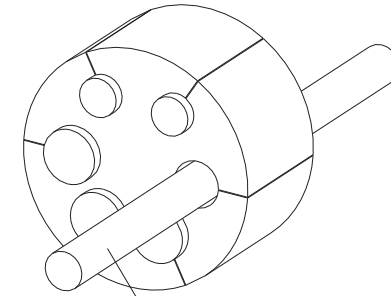

485-1

Chart 5.33

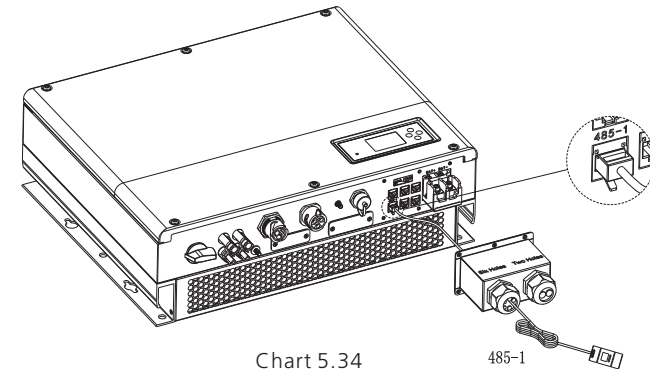

Chart 5.34

485-1

Note:

- 1.Meter and CT can't be installed at same time, please set the sensor model when selecting CT or electricity meter, please refer to section 6.3.3 for details.
- 2.Meter must be provided by Growatt. If not, maybe meter can't communicate with SPH inverter.
- 3.The more detail describe of meter installation, please turn to meter user manual.

5.5.6 Connection of communication terminal of lithium battery (CAN)

When using CAN communication with lithium batteries (for example PYLON US2000B), connect lithium battery terminal (RJ45) steps as follows:

1. Unscrew the swivel nut from the cable gland.
2. Thread the swivel nut over the "CAN" cable.
3. Press the cable support sleeve out of the cable gland.
4. Remove the filler plug from the cable support sleeve.
5. Route the "CAN" cable through an opening in the cable support sleeve.
6. Thread the "CAN" cable through the cable gland.
7. Insert the RJ45 plug of the network cable into the "CAN" pin connector on the inverter until it snaps into place.
8. If no other cables need to be installed, lock the waterproof cover to the inverter with screws.
9. Screw the swivel nut onto the waterproof cover.

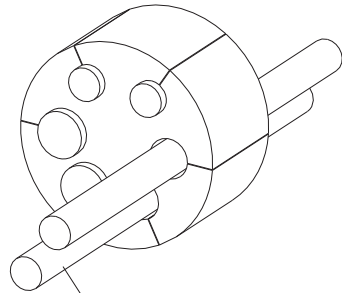

CAN

Chart 5.35

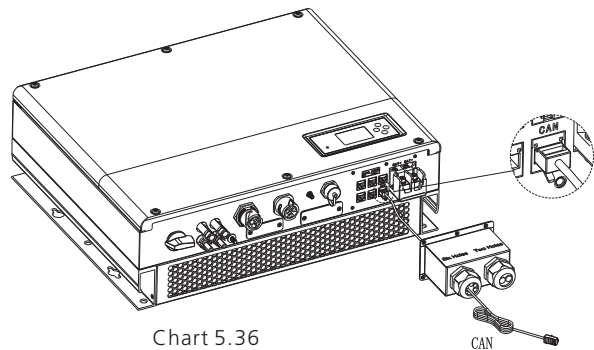

Chart 5.36

CAN

Note:

1. If you are using a lead-acid battery, you do not need to install this communication cable.
2. The CAN battery communication and 485-2 battery communication can't be installed at same time, please select the correct communication method according to the battery manual.
3. If the cable such as "485-2" cable or "CAN" cable is not used, please do not remove the filler plug from the cable support sleeve.

5.5.7 Connection of communication terminal for lithium battery (RS485)

When using lithium batteries which need to connect BMS system of the battery, connect lithium battery terminal (RJ45) steps as follows:

1. Unscrew the swivel nut from the cable gland.
2. Thread the swivel nut over the "RS485" cable.
3. Press the cable support sleeve out of the cable gland.
4. Remove the filler plug from the cable support sleeve.
5. Route the "RS485" cable through an opening in the cable support sleeve.
6. Thread the "RS485" cable through the cable gland.
7. Insert the RJ45 plug of the network cable into the "RS485-2" pin connector on the inverter until it snaps into place.
8. If no other cables need to be installed, lock the waterproof cover to the inverter with screws.
9. Screw the swivel nut onto the waterproof cover.

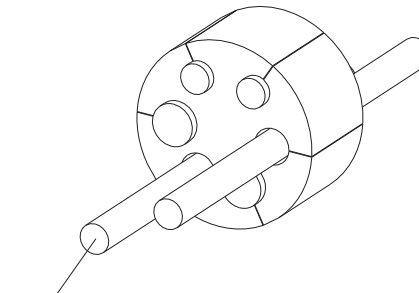

485-2

Chart 5.37

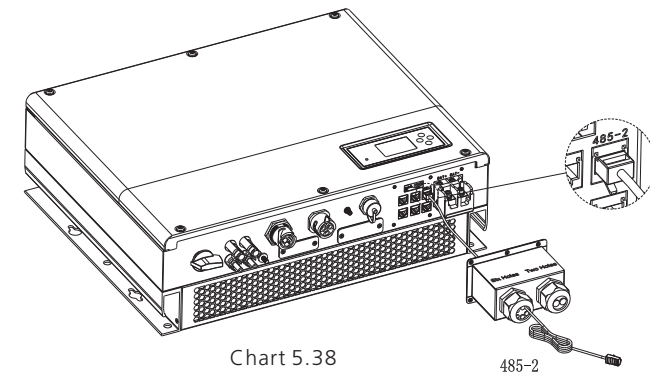

Chart 5.38

485-2

Note:

1. If you are using a lead-acid battery, you do not need to install this communication cable.
2. The CAN battery communication and 485-2 battery communication can't be installed at same time, please select the correct communication method according to the battery manual.
3. If the cable such as "485-2" cable or "CAN" cable is not used, please do not remove the filler plug from the cable support sleeve.

5.5.8 Connection of DRMS terminal (Australia only)

When SPH is applied to Australia, the DRMS terminals need to be connected, the connection way appears as follows:

1. Unscrew the swivel nut from the cable gland.
2. Thread the swivel nut over the "DRMS" cable.
3. Press the cable support sleeve out of the cable gland.
4. Remove the filler plug from the cable support sleeve.
5. Route the "DRMS" cable through an opening in the cable support sleeve.
6. Thread the "DRMS" cable through the cable gland.
7. Insert the RJ45 plug of the network cable into the "DRMS" pin connector on the inverter until it snaps into place.
8. If no other cables need to be installed, lock the waterproof cover to the inverter with screws.
9. Screw the swivel nut onto the waterproof cover.

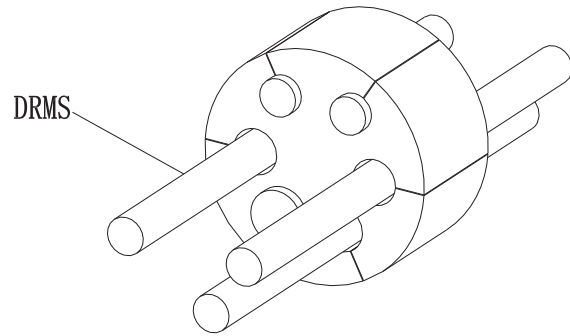

Chart 5.39

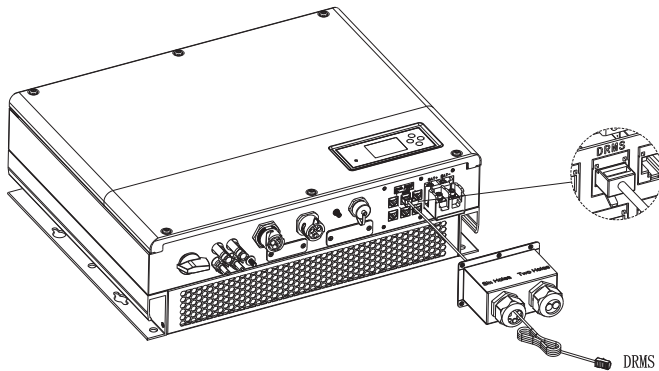

Chart 5.40

RJ45 terminal pin assignment

PIN	Assignment for inverter scapable of both charging and discharging
1	DRM5
2	DRM6
3	DRM7
4	DRM8
5	RefGen
6	COM/DRM0
7	/
8	/

Method of asserting demand response modes

MODE	RJ 45 socket asserted by shorting pins		Requirement
DRM0	5	6	Operate the disconnection device
DRM5	1	5	Do not generate power
DRM6	2	5	Do not generate at more than 50% of rated power
DRM7	3	5	Do not generate at more than 75% of rated power and sink reactive power if capable
DRM8	4	5	Increase power generation (subject to constraints from other active DRMs)

Note:

If the cable such as "NTC" (lead-acid battery temperature sensor) cable is not used, please do not remove the filler plug from the cable support sleeve.

5.5.9 Connection of temperature probe for lead-acid battery

When customer using lead-acid battery, the temperature probe of the lead-acid battery is used to detect the ambient temperature of the lead-acid battery, the battery temperature cable of the SPH side connection steps are as follows:

1. Unscrew the swivel nut from the cable gland.
2. Thread the swivel nut over the "NTC" cable.
3. Press the cable support sleeve out of the cable gland.
4. Remove the filler plug from the cable support sleeve.
5. Route the "NTC" cable through a min opening in the cable support sleeve.
6. Thread the "NTC" cable through the cable gland.
7. Insert the RJ45 plug of the network cable into the "NTC" pin connector on the inverter until it snaps into place.
8. If no other cables need to be installed, lock the waterproof cover to the inverter with screws.
9. Screw the swivel nut onto the waterproof cover.

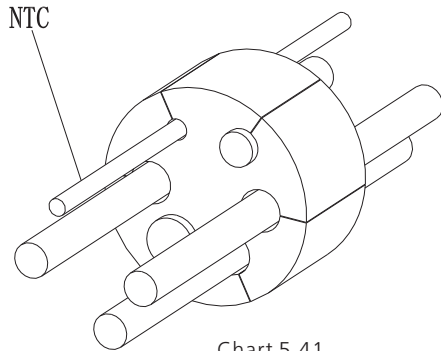

Chart 5.41

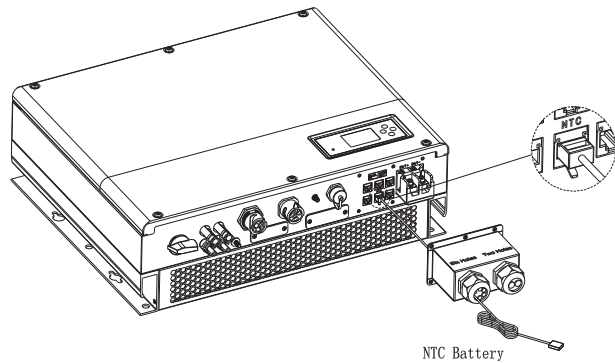

Chart 5.42

Note:

1. If you are using a lithium battery, you do not need to install this temperature probe, the probe of the temperature cable should be attached to the surrounding environment of the lead-acid battery, and the length of this cable is 1.5m, so pay attention to the distance of battery and SPH.
2. If the cable such as "NTC" (lead-acid battery temperature sensor) cable is not used, please do not remove the filler plug from the cable support sleeve.

5.5.10 Connection of Dry contact

The dry contact is used to communicate with external devices (such as remote start hot water heater). The wiring steps are as follows:

1. Unscrew the swivel nut from the cable gland.
2. Thread the swivel nut over the cable.
3. Press the cable support sleeve out of the cable gland.
4. Remove the filler plug from the cable support sleeve.
5. Route the network cable through an opening in the cable support sleeve.
6. Thread the network cable through the cable gland.
7. Thread cables into connection terminal of the inverter, then press the terminal by relevant tools and make sure cables are firmly.
8. If no other cables need to be installed, lock the waterproof cover to the inverter with screws.
9. Screw the swivel nut onto the waterproof cover.

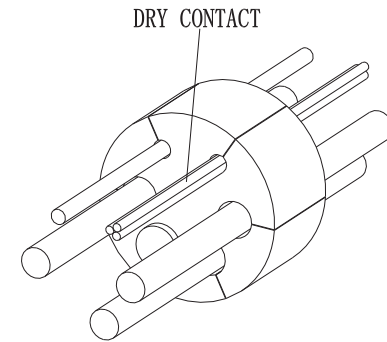

Chart 5.43

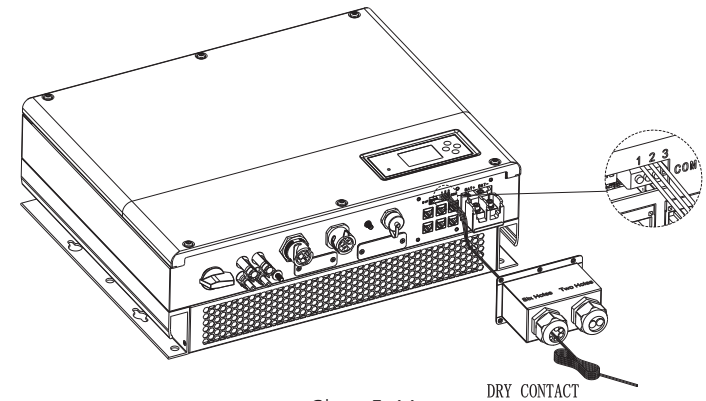

Chart 5.44

Note:

1. If the cable such as "Dry contact" cable is not used, please do not remove the filler plug from the cable support sleeve.

5.5.11 Tighten the waterproof cover

When all the communication lines are installed, push the waterproof cover into the bottom, lock the screws fixed to the frame, and finally lock the waterproof cap.

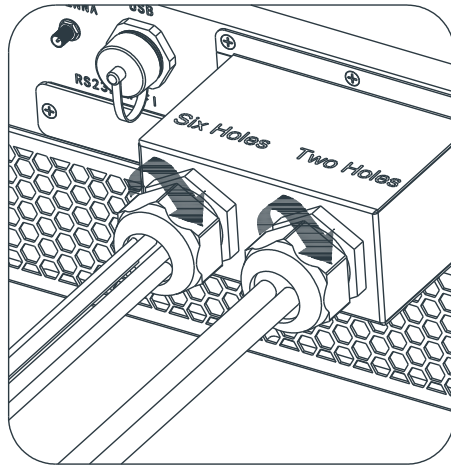

Chart 5.45

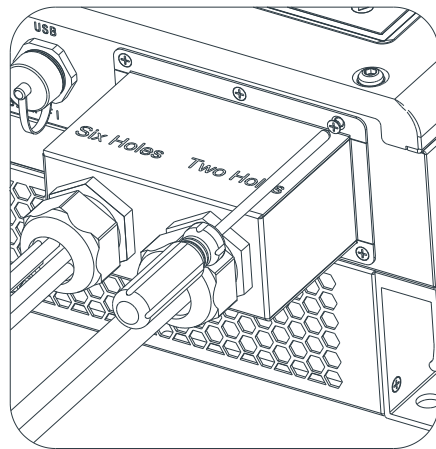

Chart 5.46

6.1 Commissioning of SPH

Electrify SPH after all installation of Part5 be finished, here are the steps:

- 1.Connect PV
- 2.Connect AC
- 3.Connect battery
- 4.Turn on AC first
- 5.Then turn on battery
- 6.Last turn on PV

If PV Grid and battery are available, system would work on the "normal" mode. When the SPH on the normal mode, the screen showing "Normal", LED is green. If SPH not enter normal mode successful, especially the LCD is red, you need to check below:

- 1.Make sure all the connection is correct.
- 2.All the external switches are on.
- 3.Inverter built-in switch is on.
- 4.Make sure the lithium battery is on.
- 5.Refer to Part 9.1 for correction.

You can refer to Part 6.3.4 for work mode setting, then configure monitor, finish commissioning lastly.

The SPH inverter will be set to the appropriate model according to the standards of different countries or regions before leaving the factory. For example, the inverter shipped to Australia are configured as Australian model in the factory.

Note: The inverter is configured for Australia at the factory.

6.2 Operation modes

6.2.1 Normal mode

Normal mode is working state which including online mode and backup mode.

Online mode

User can set an appropriate priority mode according to request when SPH working on the online mode. If customer use the LCD and key settings, you can only set one period, but if you use website settings, you can set up to three periods of the priority mode. .
(refer to 6.3.4)

1.Load first: Load first is the default mode, when it's working in this mode, PV energy would offer to load and battery prior; when PV is Insufficient, battery would discharge; when PV is sufficient for load ,the excess energy would feed to battery. If there is no battery or battery is full ,the excess energy would feed to Grid(except anti-reflux).

2.Battery first: When SPH working in this mode, battery would be charged first, it's suitable working on the period when the electric charge is low. User need to set the mode ON and OFF time, and the end time of battery SOC. User can set power rate which less than the battery maximum output power. If the customer don't enable the AC CHG (AC grid charging function). Inverter will charge battery by PV power as large as it can do. If the customer enable the AC CHG (AC grid charging function). Inverter will charge battery by PV power and AC power from grid as large as it can do.

3. Grid-first : When SPH working in Grid-first mode, the PV energy would feed to Grid first. User can choose the period when electric charge is high. User need to set the mode ON and OFF time, and the end time of battery SOC. User can set power rate which less than the battery maximum output power.

Backup mode

If Grid lost ,system would turn to backup mode(user can disable it ,refer to 6.3.4)and AC output from EPS LOAD port,all the energy from PV and battery ,if the battery also lost ,then only battery discharge. Mind you ,SPH maximum output power is 3000W in this mode, the load which connect with EPS LOAD should less than 3000W

Notice:

1. User only can set one period for battery first and Grid first on the LCD,if user need set more please login shineserver.
- 2.If user need Grid charge battery, user need input password on the SC surface and set the AC CHG to enable .

6.2.2 Fault mode

The SPH's intelligent control system could monitor and adjustment system's status continuously, when SPH inverter monitoring anything unexpected happen, such as system fault or machine fault ,the LCD will display the fault information, in fault mode, the LED light will be lighten.

Notice:

- 1.The detail's fault information please refer to 9.1.
- 2.Some fault information is in order to remind users that might have some faults occurred in inverter side.

6.2.3 Programming mode

Programming mode indicates the SPH is updating ,don't cut out power when it's updating until the processing is finish,SPH inverter would log out automatically when the updating finish and turn to other mode .

6.2.4 Checking mode

Before SPH work in normal mode, it will go to self-check mode. If all are ok, system will go to normal mode , otherwise, it will go to fault mode .

6.2.5 Standby mode

If the system hasn't fault while the condition is not qualified,SPH would stay at standby mode.

6.2.6 Shutdown mode

If customer need SPH inverter stop working, customer must disconnect all the energy source, then SPH inverter will turn into shutdown mode automatically. The following is the shutdown procedure:

1. Shutdown the PV side
2. Turn off battery switch.
3. Shut down AC power of SPH. Then you can see the both LED and LCD of SP are off.

Notice:

After all the actions are done, you still have to wait for more than 5 minutes.

6.3 Country setting

Growatt can provide various regulations of the machine, after customers receive the machine, according to their country, by dialing DIP switch to set the corresponding regulations. Following is the DIP switch introduction.

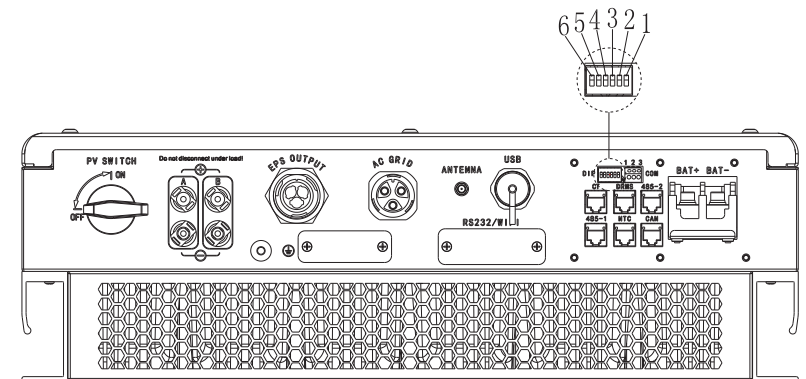

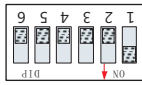
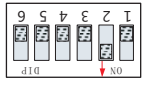
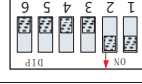
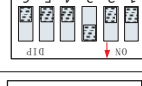
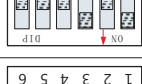
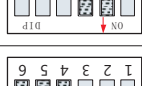

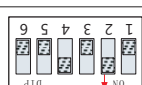
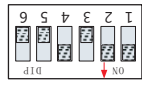
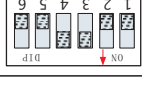



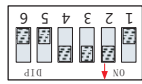
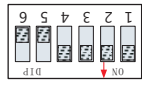
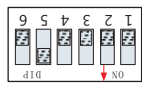
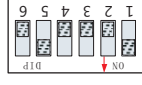
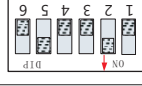
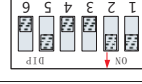
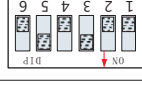
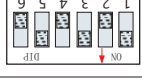
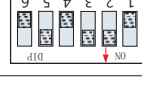
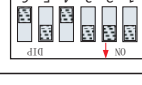

Chart 6.1

 <p>DANGER</p>	<p>Caution :</p> <p>When you setting the DIP, you must turn off PV switch, AC breaker and Battery to make sure all of the power are off.</p>
	<p>Caution:</p> <ol style="list-style-type: none"> 1. After setting the DIP, please power on the inverter and check the model display (show as 6.3.1). If the model display is match what you want, it means your setting is successful. 2. You need to calibrate the time that the machine is showing after inverter starts up. If the country is set incorrectly, please shut down the inverter and set again.

The DIP switch is composed of six-digit binary number PINS. The different combination of the six PINS can represent different inverter's model, which is corresponding to the local grid standard. Each small white PIN has two statuses, when set upward to "ON", its value turns to "1", when set downward, its value turns to "0". Concerning the matching of the PIN status and the country safety standard, please refer to the table below:

6.3.1 Switch to country table

DIP switch status	Country/region / regulations	Model display
	VDE 0126	GT0XXXXXX1
	Queensland	GT0XXXXXX2
	AS4777-Australia	GT0XXXXXX3
	CEI 0-21	GT0XXXXXX4
	G59	GT0XXXXXX5
	Greece	GT0XXXXXX6
	VDE-AR-N 4105	GT0XXXXXX7
	G83	GT0XXXXXX8
	EN50438-Norway	GT0XXXXXX9
	CQC	GT0XXXXXXA
	Danmark	GT0XXXXXXB
	Hungary	GT0XXXXXXC
	Belgium	GT0XXXXXXD

	Thailand MEA	GT0XXXXXXE
	Thailand PEA	GT0XXXXXXF
	Spain	GT1XXXXXX0
	CQC-1	GT1XXXXXX1
	Taiwan	GT1XXXXXX2
	EN50438-Ireland	GT1XXXXXX3
	TUV000	GT1XXXXXX4
	Brazil	GT1XXXXXX5
	EN50438-Sweden	GT1XXXXXX6
	Denmark	GT1XXXXXX7
	AS4777-New Zealand	GT1XXXXXX8
	France	GT1XXXXXX9

6.4 Display and button

6.4.1 LCD display area

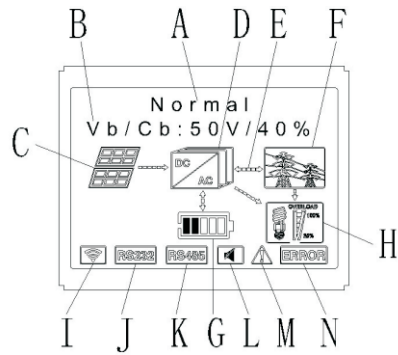

Chart 6.2

Location	Description
A	State
B	Information
C	PV input (If you connect two tracks, it will show two. Otherwise show one)
D	SPH inverter
E	Power flow line
F	Grid
G	Battery (Show the SOC in five grid, Every grid represents 20%)
H	Local load
I	Wireless communication
J	RS 232
K	RS 485
L	Buzzer(Reserved)
M	Warning
N	Fault

6.4.2 LED and button instruction

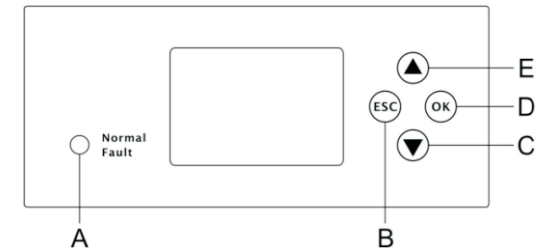

Chart 6.3

Location	Description
A	Status
B	ESC - button(cancel control)
C	Down-button
D	Enter-button
E	UP-button

Notice : LED showing status of SPH, it has two color, one is green and another is red. Please turn to 3.1 and read the detail of LED.

6.4.3 LCD display column

LCD display column is used to show the current state, basic information and fault information. Also include language setting, program charging/discharging priority and system time. On default condition will take turns to display the information.

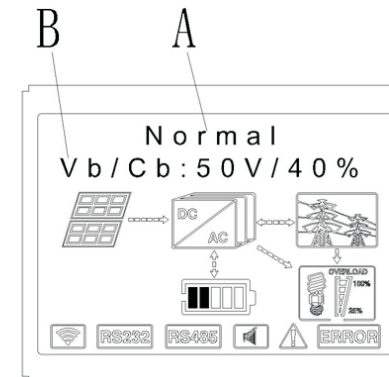

Chart 6.4

The A line's concluding information as follow:

1. Standby state: SPH is in standby state. No error in this state, but for other reasons, make it in a wait state.
2. Normal state: SPH is normal working state.
3. Checking state: SPH is in self-check state, if there is no error or warning, SPH will go to normal state or standby state. Otherwise it will go to fault state.
4. Programming state: SPH is in updating firmware state.
5. Fault state : SPH has fault information, it will be in stopped operational protection state.

The B line's information as follow:

In normal, it will turn on page automatically, when pushing the button "UP", the order of the paging information as follow:

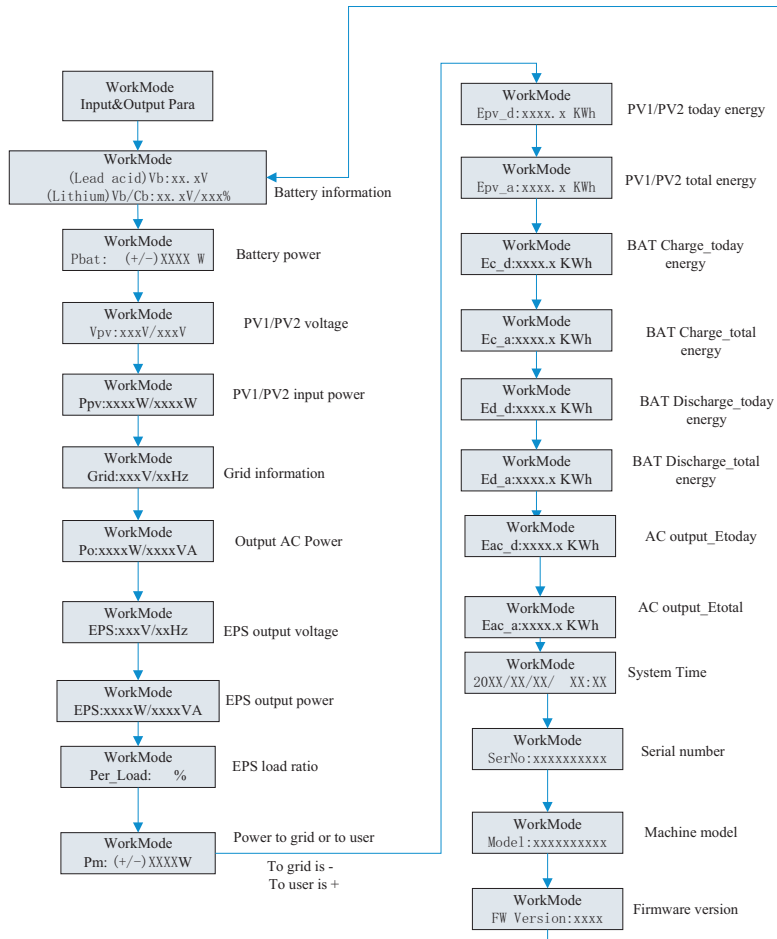

Chart 6.5

Note:

1. "Down" control command (if pushing "up" button, command will go back)
2. Workmode depend on the situation. If SPH is normal state, it will show "normal". If SPH is standby state, it will show as "standby" etc.
3. Some special definitions are explained, for example: Vb means the voltage of battery. Cb means the capacity of lithium battery (only lithium battery show this data). Pm means the monitor power of user.

6.4.4 Work mode set up

Keep pressing "enter" for 3S, you can enter set up surface, in the set up surface you need hold button Enter or ESC 1S for selection, you can see the surface as showing below.

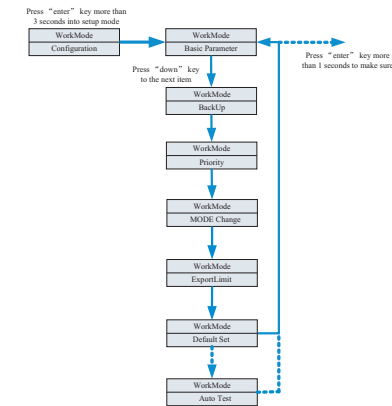

Chart 6.6

If you choose CEI and used SPH inverter in Italy, SPH inverter have Auto Test function. How to use the Auto test function. Please see the annex.

1. Under the Basic Para , you can see the setup options below after pressing Enter for 1S :

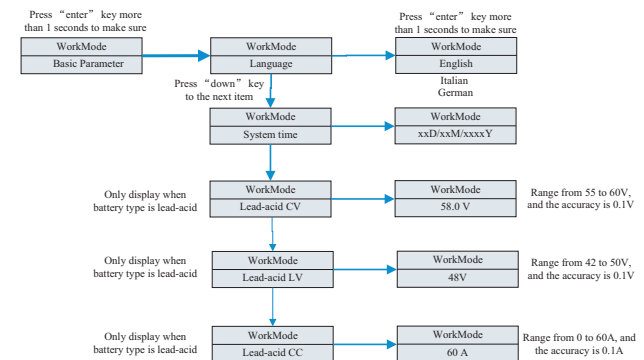

Chart 6.7

In the basic Parameter, you can set language (English, Italian, German), system time, lead-acid cell charging voltage (default is 58V), discharge low voltage (default is 48V) and lead-acid constant current (default is 60A).

2. Under the Back Up, you can see the setup options below after pressing Enter for 1S:

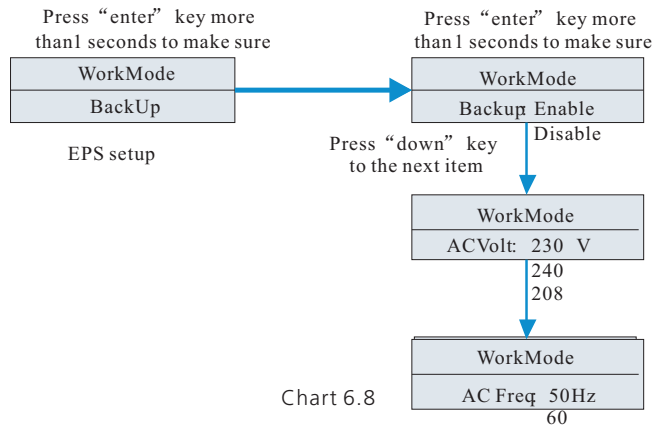

Chart 6.8

In the back up you can set EPS, including enable or disable (default is enable), AC voltage (default is 230V) and frequency (default site 50HZ).

3. Under the Priority, you can see the setup options below after pressing Enter:

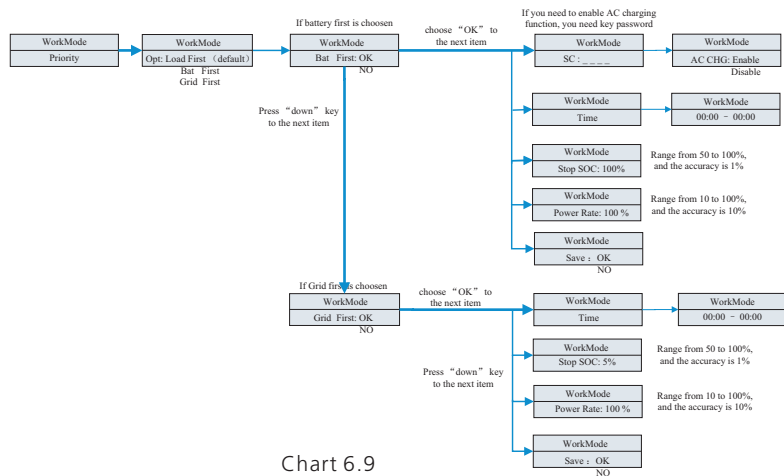

Chart 6.9

Note :

1. "Power Rate" is used to set up power of battery. So different battery may have different power, customer need to check the max power of battery.
2. Time setting is 24-hour. If the end time is less than beginning time, it defaults to spanning days.

4. Under the MODE Change, you can see the setup options below after pressing Enter:

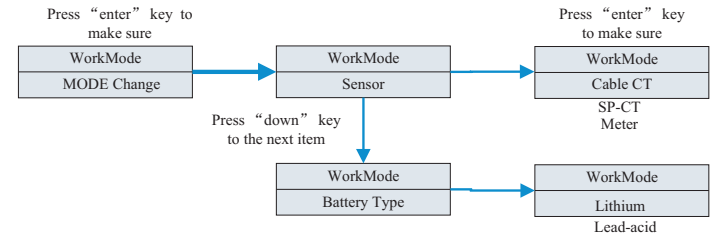

Chart 6.10

The MODE change has two options what are sensor and battery type, sensor is cable CT (default), meter and SP-CT (wireless RF transfer). In the battery type, you can choose lithium battery or lead-acid battery.

5. Under the ExportLimit, you can see the setup options below after pressing Enter:

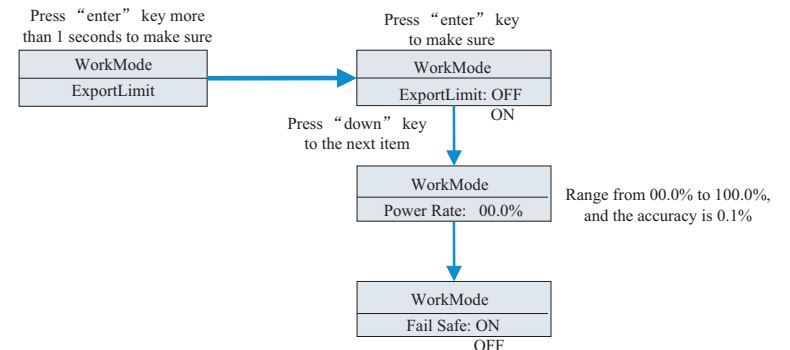

Chart 6.11

Exportlimit is used for users to control the energy flowing to the grid. If this function is enabled, the feeding power to grid will be equal or less than the setup value. The purpose of the Fail Safe function is to ensure that should any part of the ELS fail, the Active Power exported across the Connection Point will drop to the Agreed Export Capacity or less within the specified time.

Note: 1. Default value is 00.0%.

2. Fail safe works only in meter mode.

3. Fail safe works only in G99 or G98 certification.

4. If Exportlimit function is working, we can't setup priority of Grid first.

6. Under the default set, you can see the setup options below after pressing Enter:

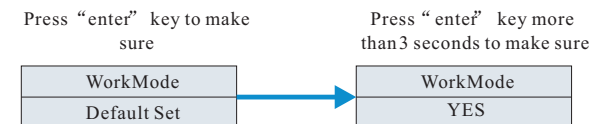

Chart 6.12

Default set is "resume to default setting", please don't use it unless it's necessary.

6.5 Communication

6.5.1 Use of USB-A port

USB-A port is mainly for firmware update :
Through USB connection, we can quickly update the software of machine.
You can see USB-A as below.

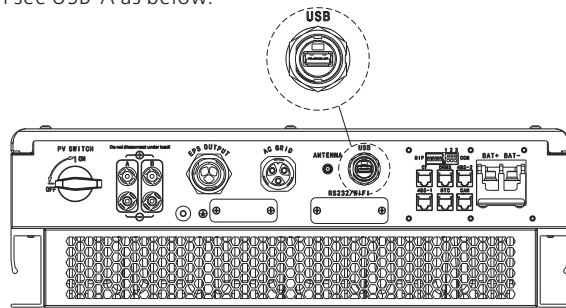

Chart 6.13

Note: USB is only used for firmware update. Customer can't use it for charging.

6.5.2 Use of RS232 port

RS232 port is mainly used for monitoring connection with PC, users can monitor ,set parameters and update the software of the machine through RS232 connection with machine and PC, using the shinebus software developed by Growatt.
About ShineBus software, when you needed, please download from official website of Growatt.

Removing RS232 cover first:

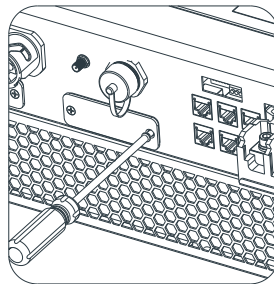

Chart 6.14

Before use RS232 communication, you should make sure the follow PIN1 and PIN2 are OFF:

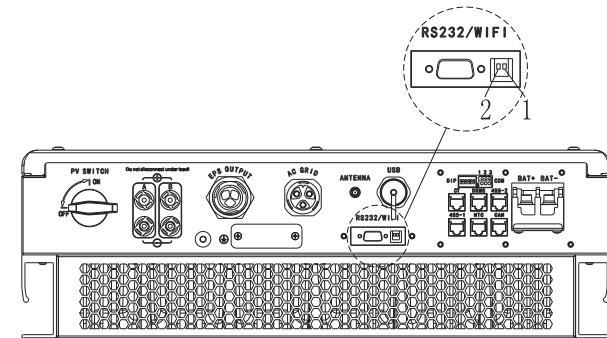

Chart 6.15

The wiring diagram is as follows:

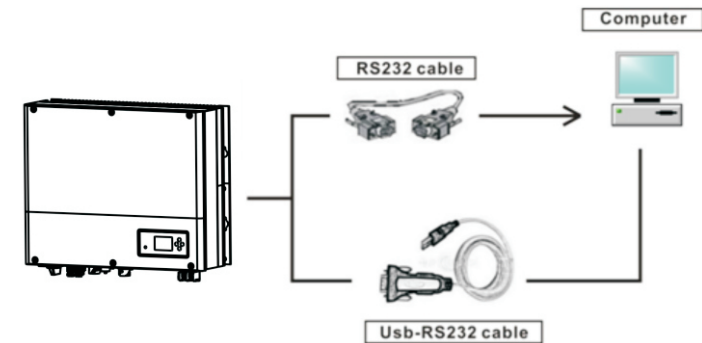

Chart 6.16

6.5.3 The SPH's monitoring

The SPH provide RS232 interface. Users can through the following communication solution to monitor the SPH. For example Using Wi-Fi-S monitor SPH as follow:

Note:

This kind of monitoring can only be used by the monitor of Growatt's Shineserver /shine phone provided by the company. Through RS232 interface connect to Wi-Fi-S/shinlink/GPRS, use computer terminal/or mobile phone for data monitoring.

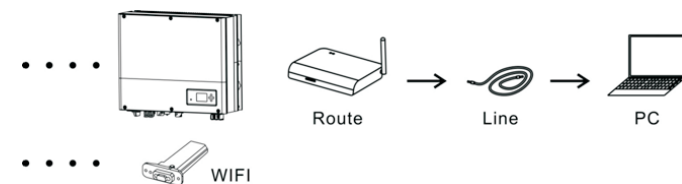

Chart 6.17

Before use Wi-Fi communication, you should make sure the follow PIN1 and PIN2 are ON:

Attention of the installation environment, maintenance and cleaning 8

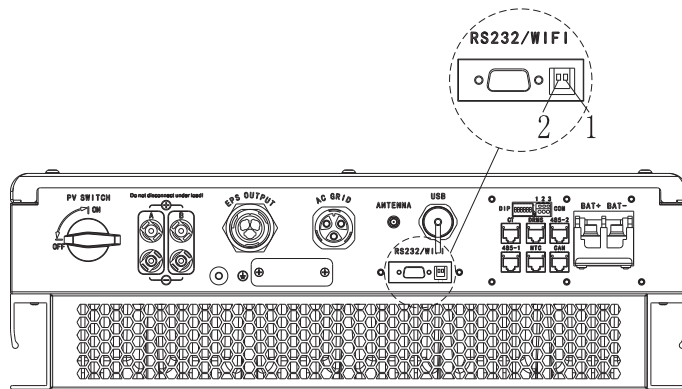

Chart 6.18

Then Plug in the communication module and tighten the screws as follow.

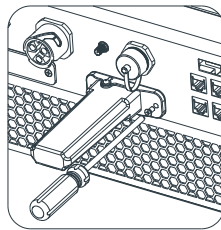

Chart 6.19

How to register account, please turn to the usermanual of shine Wi-Fi-S.

7 Start-up and shut down SP system

7.1 Start-up the SPH system

Users can start-up SPH inverters through following steps :

- 1.Connect to PV
2. Connect to Grid
- 3.Connect to Battery
4. Turn the switch on in turn of Grid,battery and PV.
5. When the LED turns green, the working information on LCD indicates the successful start-up of SPH inverter

7.2 Disconnect the SPH system

1. Turn off all the circuit breaker and switch
2. Disconnect PV
3. Disconnect the inverter
4. Disconnect the battery
5. Pull up AC PLUG connection
6. Waiting until LED,LCD display have gone out, the SPH is shut down completely

Heat dissipation performance is very important when SPH inverter work under the environment of high temperature, better heat dissipation can reduce the possibility of SPH inverter stops working. Growatt SPH series inverter without fan so belongs to natural cooling, hot air from the top of the radiator, tie-in battery, use environment for IP65, please pay attention to the temperature of the installation environment, to ensure that the battery's safety and the normal work of the machine.

When use battery, please pay attention to the follow information:

Caution: Do not dispose of batteries in a fire. The batteries may explode.

Caution: Do not open or damage batteries. Released electrolyte is harmful to the skin and eyes. It may be toxic.

Caution: A battery can present a risk of electrical shock and high short-circuit current. The following precautions should be observed when working on batteries:

- a) Remove watches, rings or other metal objects.
- b) Use tools with insulated handles.
- c) Wear rubber gloves and boots.
- d) Do not lay tools or metal parts on top of batteries.
- e) Disconnect charging source prior to connecting or disconnecting battery terminals.
- f) Determine if battery is inadvertently grounded. If inadvertently grounded, remove source from ground. Contact with any part of a grounded battery can result in electrical shock. The likelihood of such shock can be reduced if such grounds are removed during installation and maintenance (applicable to equipment and remote battery supplies not having a grounded supply circuit). If SPH inverter doesn't work for overheating or too cold, solve it according to the following methods
 - Confirm whether the radiator air duct installation is reasonable, choose the appropriate position before installation.
 - If lead-acid batteries are connected, confirming the NTC battery is in a good installation.
 - Confirm whether the battery temperature is too high, too high temperature of battery can also lead to SPH fail to work, at this point, to ventilation, cooling or still handle to the battery, please.
 - If temperature is low, also can appear the battery low temperature protection, the battery will start with small load in low temperature output, after temperature back to normal system can work normally, please be patient at this time
 - If the temperature is too low, it is possible that battery will be low temperature protection, at this time, please pay attention to the working temperature range listed in the specifications of the book.
 - Servicing of batteries should be performed or supervised by personnel knowledgeable about batteries and the required precautions.
 - When replacing batteries, replace with the same type and number of batteries or battery packs.
 - General instructions regarding removal and installation of batteries.

Remark:

All of above action should be operated by professional person, if you want to do these works, you must make sure the whole system are off.

9 Fault removal

Our products are carried out with strict tests before they take out, if the operation difficulties in the process of installation, please log on to www.ginverter.com website, view the Q&A program.

When SPH inverter fault happens, please inform our company, and to provide SPH related information, we will have a professional after-sales service personnel to answer you.

What you need to provide the information about the SPH including :
serial number

Model

Information about the LCD display

Brief description of problems

The battery voltage

The PV input voltage and power per string.

The grid voltage and frequency

Can you retell the failure problem? If you can, what kind of a situation

Did the problem happen in the past?

When did this fault happen? First installation?

About the battery

The manufacturer name and model of battery

Capacity of battery

Output voltage of the battery

The time you buy Battery and frequency you use it

9.1 System fault information list and troubleshooting suggestions

Warning Message		
Error Message	Description	Suggestion
Warning401	SP-CT/Meter Communication fault	1.Check the wire connection between meter and inverter is good or not. 2.Check the distance of SP-CT and inverter is in the range of specification or not. 3.Restart inverter and SP-CT, reconnect.
Warning 203	PV1 or PV2 Circuit short	1.Check the positive and negative of PV input is reversed or not. 2.Reinserted the PV terminal , please contact Growatt service center if restart can't solve the problem.
Warning506	Battery temperature out of specified range for charge or discharge	Check the environment temperature of battery is in the range of specification or not.
AC V Outrange	Grid voltage fault. Please refer to the local grid standard for more details of the grid frequency.	1.Check the AC voltage is in the range of standard voltage in specification. 2.Check the grid connection is good or not.
AC F Outrange	Grid frequency fault. Please refer to the local grid standard for more details for the grid voltage.	1.Check the frequency is in the range of specification or not. 2.Restart inverter. 3.Please contact Growatt service center if restart can't solve the problem.
PairingTimeOut	Communication fault	1.Check the distance of SP-CT and inverter is in the range of specification or not. 2.Restart inverter and SP-CT, reconnect.
CT LN Reversed	LN Reversed	1.Check the L line and N line of SP-CT is reversed or not. 2.Check the PE of SP-CT is connected well or not.
BMS COM Fault	Communication fault	1.Check the lithium Battery is open or not. 2.Check the connection of lithium Battery and inverter is good or not.
Battery reversed	Battery terminals reversed	Check the positive and negative of battery is reversed or not.

Warning Message		
Error Message	Description	Suggestion
BAT NTC Open	NTC open (only for lead-acid battery)	1.Checkthe temperature of lead - acid battery is installed or not. 2.Check the temperature of lead -acid battery is connected well or not.
Battery Open	Battery terminal open (only for lithium battery)	1.Check the battery connection is good or not. 2.Check the switches between the battery and inverter are all on or not.
over load	EPS output overload warning If this warning occurred three time. Off-grid function will be locked one hour and output power again	Please reduce the load of EPS output.
No AC Connection	No Utility	1.Please confirm grid is lost or not. 2.Check the grid connection is good or not. 3.Check the switches on the cable are on or not.
Output High DCI	Output DC current too high. Please refer to the local grid standard for disconnection time when the output DC current is too high.	1.Restart inverter. 2.Please contact Growattservice center if restart can't solve the problem.
BMS Warning:XXX	BMS report warning	1.Check the warning information from lithium battery usermanual. 2. Please contact Growatt service center if restart can't solve the problem.
BMS error:XXX	BMS report error	1.Check the warning information from lithium battery usermanual. 2. Please contact Growatt service center if restart can't solve the problem.
EPS Volt Low	EPS output voltage low	1.Check the load of EPS. If overload occurred, reduce load. 2.Restart inverter again.

Error Message		
Error 411	Internal communication failed	1.Restart inverter. 2.Please contact Growatt service center if restart can't solve the problem.
Error 417	Sample fault	1.Restart inverter. 2.Please contact Growatt service center if restart can't solve the problem.
Error418	DSP and COM firmware version unmatch,system fault.	Read DSP and COM firmware version from LCD or shinebus. Check if the firmware is correct.
Error 303	Inverter L N reversed or ground failed	1.Check the L line and N line is reversed or not. 2.Checkthe PE s connected well or not.
Error 405	Relay fault	1.Restart inverter. 2.Please contact Growatt service center if restart can't solve the problem.
Error 123	Autotest failed(only in Italy)	1.Restart inverter. 2.Please contact Growatt service center if restart can't solve the problem.
PV Isolation Low	PV isolation too low	1.Check the connection of PV panels and inverter is good or not. 2.Check the PE of inverter is good or not.
OP Short Fault !	EPS Output Short Fault	1.Check the load of EPS. 2.Check the output of EPS. Especial not connect to Grid
NTC Open	Internal temperature failed	Please contact Growatt service center
Error 406	Model set up not meet with certification	Please check model set or check the DIP setting
Residual I High	Leakage current too high	1.Check the cable of inverter. 2. Restart inverter. 3. Please contact Growatt service center if restart can't solve the problem
Error 408	Temperature over range	Please check the temperature is in the range of specification or not.
PV Voltage High	PV voltage higher than datasheet	Please check the voltage of PV input is in the range of specification or not.

10 EU Declaration of Conformity

With the scope of EU directives:

- 2014/35/EU Low Voltage Directive (LVD)
- 2014/30/EU Electromagnetic Compatibility Directive (EMC)
- 2011/65/EU RoHS Directive and its amendment (EU)2015/863

Shenzhen Growatt New Energy Technology Co. Ltd confirms that the Growatt inverters and accessories described in this document are in compliance with the above mentioned EU directives. The entire EU Declaration of Conformity can be found at www.ginverter.com.

11 Manufacturer Warranty

This certificate represents a 5 year warranty for the Growatt products listed below. Possession of this certificate validates a standard factory warranty of 5 years from the date of purchase.

Warranted products

This warranty is applicable solely to the following products:

Growatt-SPH3000.
Growatt-SPH3600.
Growatt-SPH4000.
Growatt-SPH4600.
Growatt-SPH5000.
Growatt-SPH6000.

Limited Product Warranty

(Applicable under normal application, installation, use and service conditions)Growatt warrants the above listed products to be free from defects and/or failure specified for a period not exceeding five (5) years from the date of sale as shown in the Proof of Purchase to the Original purchaser.

The warranties described in these "Limited Warranty" are exclusive and are expressly in lieu of and exclude all other warranties, whether written, oral, expresser implied, including but not limited to, warranties of merchantability and of fitness for a particular purpose, use ,or application, and all other obligations or liabilities on the part of GROWATT , unless such other obligations or liabilities are expressly agreed to it in writing signed and approved by GROWATT , GROWATT shall have no responsibility or liability whatsoever for damage or injury to persons or property, or for other loss or injury resulting from any cause whatsoever arising out of or related to the modules, including, without limitation, any defects in the modules or from use or installation. Under no circumstances shall GROWATT be liable for incidental, consequential or special damages howsoever caused; loss of use, loss of production, loss of revenues are therefore specifically and without limitation excluded to the extent legally permissible, GROWATT 's aggregate liability, if any, in damages or otherwise, shall not exceed the invoice as paid by the customer.

The "Limited Product Warranty" described above shall not apply to, and Growatt shall have no obligation of any kind whatsoever with respect to, any machine which has been subjected to:

- Misuse, abuse, neglect or accident;
- Alteration, improper installation or application;
- Unauthorized modification or attempted repairs;
- Insufficient ventilation of the product;
- Transport damage;
- Breaking of the original manufacturers seal;
- Non-observance of Growatt installation and maintenance instruction;
- Failure to observe the applicable safety regulations.
- Power failure surges, lighting, flood, fire, exposure to incorrect use, negligence, accident, force majeure, explosion, terrorist act, vandalism or damage caused by incorrect installation, modification or extreme weather conditions or other circumstances not reasonably attributable to Growatt.

The warranty shall also cease to apply if the product cannot be correctly identified as the product of Growatt. Warranty claims will not be honored if the type of serial number on the machines have been altered, removed or rendered illegible.

Liability

The liability of Growatt in respect of any defects in its machines shall be limited to compliance with the obligations as stated in these terms and conditions of warranty. Maximum liability shall be limited to the sale price of the product. Growatt shall accept no liability for loss of profit, resultant of indirect damage, any loss of electrical power and / or compensation of energy suppliers within the express meaning of that term.

The warranty rights as meant herein are not transferable or assignable to any third party excepting the named warranty holder.

Warranty Conditions

If a device becomes defective during the agreed Growatt factory warranty period and provided that it will not be impossible or unreasonable, the device will be, as selected by Growatt:

1. Shipped to a Growatt service center for repair;
2. Repaired on-site;
3. Exchanged for a replacement device of equivalent value according to model and age.

The warranty shall not cover transportation costs in connection with the return of defective modules. The cost of the installation or reinstallation of the modules shall also be expressly excluded as are all other related logistical and process costs incurred by all parties in relation to this warranty claim.

12 Decommissioning

12.1 Dismantling the energy storage

1. Disconnect the storage machine such as mentioned in section 7.
2. Disconnect the upper cable of SPH inverter.



Watch out the SPH's shell heat and prevent to scald
Wait 20 minutes until the SPH cooling and then to disassembly!

3. Unscrew all the connecting cable.
4. Unscrew the radiator and wall-mounted anchor screw and then take down the machine from wall .

12.2 Packing the SPH inverter

Usually placed SPH inverter in the packing box with tape sealing, if the SPH inverter cannot reoccupy, You can choose a cheap carton for packaging. Carton requirements must meet the size of the inverter and can support energy storage machine overall weight.

12.3 Storing SPH inverter

Store SPH inverter in a dry place where ambient temperatures are always between - 25°C and +60°C

12.4 Disposing of the SPH inverter



Do not dispose of SPH inverter together with household waste. Please accordance with the disposal regulations for electronic waste which apply at the installation site at that time. Ensure that the old unit and, where applicable, any accessories are disposed of in a proper manner.

Product Specification 13

13.1 Growatt SPH series energy storage machine product specification

Model	Growatt SPH3000	Growatt SPH3600	Growatt SPH4000	Growatt SPH4600	Growatt SPH5000/4999*1	Growatt SPH6000
Specifications						
Input data (DC)						
Max. recommended PV power(for module STC)	3300W/3300W	3300W/3300W	3300W/3300W	4000W/4000W	4000W/4000W	4000W/4000W
Max. DC voltage	550V	550V	550V	550V	550V	550V
Start voltage	150V	150V	150V	150V	150V	150V
PV voltage range	120V-550V	120V-550V	120V-550V	120V-550V	120V-550V	120V-550V
MPP work voltage range/ nominal voltage	150V-550V/360V	150V-550V/360V	150V-550V/360V	150V-550V/360V	150V-550V/360V	150V-550V/360V
Full load dc voltage range	275V-440V	275V-440V	275V-440V	340V-440V	340V-440V	340V-440V
Max. input current of tracker A/ tracker B	12A/12A	12A/12A	12A/12A	12A/12A	12A/12A	12A/12A
Max. short current	12A	12A	12A	12A	12A	12A
Number of independent MPP trackers / strings per MPP tracker	2/1	2/1	2/1	2/1	2/1	2/1
Backfeed current to the array	0A	0A	0A	0A	0A	0A
DC overvoltage category	Category II					
Output (AC)						
Rated AC output power	3000W	3680W	4000W	4600W	4999W	6000W
Max. AC apparent power	3000VA	3680VA	4000VA	4600VA	4999VA	6000VA
Max. output current	16A	16A	22A	22A	22A	27A
AC nominal voltage; range	230V ; 180Vac-280Vac	230V ; 180Vac-280Vac	230V ; 180Vac-280Vac	230V ; 180Vac-280Vac	230V ; 180Vac-280Vac	230V ; 180Vac-280Vac
Max inrush peak current	34.6A	34.6A	34.6A	34.6A	34.6A	34.6A
Max output fault peak current	65A	65A	65A	65A	65A	65A
Max output overcurrent protection	65A	65A	65A	65A	65A	65A
AC grid frequency; range	50/60,±5Hz					

Model	Growatt SPH3000	Growatt SPH3600	Growatt SPH4000	Growatt SPH4600	Growatt SPH5000	Growatt SPH6000
Specifications						
Phase factor at rate power	1	1	1	1	1	1
Displacement power factor, configurable*	0.8leading ...0.8 lagging	0.8leading ...0.8 lagging	0.8leading ...0.8 lagging	0.8leading ...0.8 lagging	0.8leading ...0.8 lagging	0.8leading ...0.8 lagging
THDI	<3%	<3%	<3%	<3%	<3%	<3%
AC connection	Single phase	Single phase	Single phase	Single phase	Single phase	Single phase
AC overvoltage category	Category III					
Stand alone(AC power)						
Rated AC output power	3000W*1	3000W*1	3000W*1	3000W*1	3000W*1	3000W*1
Rated AC output voltage	230Vac	230Vac	230Vac	230Vac	230Vac	230Vac
Rated AC output frequency	50/60Hz	50/60Hz	50/60Hz	50/60Hz	50/60Hz	50/60Hz
Starting mode	Setup	Setup	Setup	Setup	Setup	Setup
BAT data(DC)						
Battery voltage range	42~59V	42~59V	42~59V	42~59V	42~59V	42~59V
Max charging voltage	58V	58V	58V	58V	58V	58V
Max charging and discharging current	66A	66A	66A	66A	66A	66A
Max charging and discharging power	3000W*2	3000W*2	3000W*2	3000W*2	3000W*2	3000W*2
Type of battery	lithium / Lead-acid	lithium / Lead-acid	lithium / Lead-acid	lithium / Lead-acid	lithium / Lead-acid	lithium / Lead-acid
DoD	80% /50%	80% /50%	80% /50%	80% /50%	80% /50%	80% /50%
Capacity of battery	3~12kWh	3~12kWh	3~12kWh	3~12kWh	3~12kWh	3~12kWh
Efficiency						
Max. efficiency	97.1%	97.2%	97.2%	97.3%	97.3%	97.5%
Euro weighted efficiency	96.8%	96.9%	96.9%	97%	97%	97.1%
CEC efficiency						
MPPT efficiency	99.5%	99.5%	99.5%	99.5%	99.5%	99.5%
Protection devices						
DC reverse polarity protection	yes	yes	yes	yes	yes	yes

Model	Growatt SPH3000	Growatt SPH3600	Growatt SPH4000	Growatt SPH4600	Growatt SPH5000	Growatt SPH6000
Specifications						
BAT reverse protection	yes	yes	yes	yes	yes	yes
Output over current protection	yes	yes	yes	yes	yes	yes
Output over voltage protection-varistor	yes	yes	yes	yes	yes	yes
Ground fault monitoring	yes	yes	yes	yes	yes	yes
Grid monitoring	yes	yes	yes	yes	yes	yes
Integrated all - pole sensitive leakage current monitoring unit	yes	yes	yes	yes	yes	yes
General Data						
Dimensions (W / H / D) in mm	450*565 *180	450*565 *180	450*565 *180	450*565 *180	450*565 *180	450*565 *180
Weight	27KG	27KG	27KG	27KG	27KG	27KG
Operating temperature range	-25°C ... +60°Cwith derating above 45°C	-25°C ... +60°Cwith derating above 45°C	-25°C ... +60°Cwith derating above 45°C	-25°C ... +60°Cwith derating above 45°C	-25°C ... +60°Cwith derating above 45°C	-25°C ... +60°Cwith derating above 45°C
Noise emission (typical)	≤ 25 dB(A)	≤ 25 dB(A)	≤ 25 dB(A)	≤ 25 dB(A)	≤ 25 dB(A)	≤ 25 dB(A)
Altitude	2000m	2000m	2000m	2000m	2000m	2000m
Self-Consumption	< 4 W	< 4 W	< 4 W	< 4 W	< 4 W	< 4 W
Inverter Topology	transformerless	transformerless	transformerless	transformerless	transformerless	transformerless
DC/DC topology	HF transformer	HF transformer	HF transformer	HF transformer	HF transformer	HF transformer
Cooling concept	Natural	Natural	Natural	Natural	Natural	Natural
Environmental Protection Rating	IP65	IP65	IP65	IP65	IP65	IP65
Relative humidity	100%	100%	100%	100%	100%	100%
Features						
DC connection	MC4/H4 (opt)	MC4/H4 (opt)	MC4/H4 (opt)	MC4/H4 (opt)	MC4/H4 (opt)	MC4/H4 (opt)
AC connection	connector	connector	connector	connector	connector	connector

Model	Growatt SPH3000	Growatt SPH3600	Growatt SPH4000	Growatt SPH4600	Growatt SPH5000	Growatt SPH6000
Specifications						
BAT connection	Screw	Screw	Screw	Screw	Screw	Screw
Display	LCD	LCD	LCD	LCD	LCD	LCD
Interfaces: RS485/USB /CAN/Wi-Fi/GPRS	yes /yes /opt/opt/opt	yes /yes /opt/opt/opt	yes /yes /opt/opt/opt	yes /yes /opt/opt/opt	yes /yes /opt/opt/opt	yes /yes /opt/opt/opt
Warranty: 5 years / 10 years	yes /opt	yes /opt	yes /opt	yes /opt	yes /opt	yes /opt
Certificates and approvals	CE,IEC62109,G98,G100,VDE0126-1-1,G59,AS4777,AS/NZS3100,CE 0-21,VDE-AR-N4105,EN50438,VFR,MEA,PEA,IEC6127,IEC62116,TR3.3.1	CE,IEC62109,G98,G100,VDE0126-1-1,G59,AS4777,AS/NZS3100,CE 0-21,VDE-AR-N4105,EN50438,VFR,IEC61727,IEC62116,TR3.3.1	CE,IEC62109,VDE0126-1-1,G99,G100,AS4777,AS/NZS 3100,CEI0-21,VDE-AR-N4105,EN50438,VFR,IEC61727,IEC62116	CE,IEC62109,G83,VDE 0126-1-1,G99,G100,AS4777,AS/NZS3100,CE 0-21,VDE-AR-N4105,En50438,VFR,IEC61727,IEC62116	CE,IEC62109,G83,VDE 0126-1-1,G99,G100,AS4777,AS/NZS3100,CE 0-21,VDE-AR-N4105,En50438,VFR,IEC61727,IEC62116	CE,IEC62109,G83,VDE 0126-1-1,G99,G100,AS4777,AS/NZS3100,CE 0-21,VDE-AR-N4105,En50438,VFR,IEC61727,IEC62116

13.2 PV input terminal parameter

MC 4 specification:

DC connector	MC4(multi-contact)/H4(opt)			
	2.5mm ² /14AWG	4mm ² /12 AWG	6mm ² /10 AWG	10mm ² /8AWG
Rated current (90°Cenvironment)	32A	40A	44A	65A
Nominal system voltage	600V DC(UL) 600V DC(TUV)			
Contact resistance	0.25mΩ (model)			
Protection grade	IP 68			

Socket contact materials	Copper, tin
Insulation materials	Thermoplastics UL94 V-0
Ambient temperature range	-40°C to +90°C
Wire stripping length	7.0mm(9/32)
Cable casing diameter	4.5 to 7.8mm(3/16: to 5/16")

13.3 Torque

Upper cover screws	1.3Nm(10.8 1bf.in)
Shell and RS232screws	0.7Nm(6.2 1bf.in)
Dc connector	1.8Nm(16.0 1bf.in)
M6 screwdriver	2Nm(18 1bf.in)
Grounding screw	2Nm(18 1bf.in)

13.4 Appendix

The following chart is the energy storage machine optional appendix list, if there is a need please contact the Growatt New Energy Technology Co., Ltd or dealer orders.(P/N is only for reference,and it may be changed.)

Name	Description	GROWATT P/N
Shine link	Used for data record	MR00.0007200
Shine Wi-Fi-S	Used for data record	MR00.0008600
GPRS	Used for data record	MR00.0009601
SP-CT	Wireless meter sensor	MR00.0006700
	Wireless meter sensor(British plug)	MR00.0006800
SPM(Single phase meter)	RS 485 meter sensor(Estron)	MR00.0008800
	RS 485 meter sensor(CHNT)	MR00.0010800
TPM(three phase meter)	RS 485 meter sensor (standard)	MR00.0008300
	RS 485 meter sensor (for Italy)	MR00.0008400
TSSP	using for on grid and off grid switch manual	TV03.0001200
A-TSSP	using for on grid and off grid switch auto	TV03.0003100

14 Certificate

Growatt SPH series inverter apply within the scope of the world, So the inverter have to satisfy different countries and regions of different safety standards.

Model	Certificate
Growatt SPH3000 Growatt SPH6000	CE,IEC62109,G98,G100,VDE0126-1-1,AS4777, AS/NZS3100, CEI0-21,VDE-AR-N4105,EN50438, VFR,MEA,PEA,IEC61727,IEC62116,TR3.3.1
Growatt SPH3600 Growatt SPH4000 Growatt SPH4600 Growatt SPH5000	CE,IEC62109,G99,G100,VDE0126-1-1,AS4777, AS/NZS3100, CEI0-21,VDE-AR-N4105,EN50438, VFR,IEC61727,IEC62116

15 Contact

If you have technical problems about our products, contact the Growatt Service line or dealer. We need the following information in order to provide you with the necessary assistance:

1. SPH inverter Serial number
2. SPH inverter module information
3. SPH inverter communication mode
4. SPH inverter fault information code
5. SPH inverter Display content
6. The manufacturer and model of the battery
7. Battery capacity and connection mode

Shenzhen Growatt New Energy Technology Co.,LTD
 No.28 Guangming Road, Shiyang Street, Bao'an District, Shenzhen, PR.China
 T : +86 0755 2747 1942
 E : service@ginverter.com
 W : www.ginverter.com

Annex

Auto Test (only for Italy)

Follow is the chart of Auto Test, refer to 6.4.4. in the set up surface of "Auto Test". Press the "Enter" key, make sure to start auto test by press "enter" key 3 seconds. The LCD will display the follow message.

