

AI BOOST Optimal Electricity Cost & Active Safety

FusionSolar Residential Smart PV Solution



01 Company
Introduction

02 FusionSolar Residential
Smart PV Solution

03 Summary

Cumulative 130GW+ Global Shipments, Leading String Solution to become the Mainstream

The Leading Brand for Global Inverter Shipment



String Solution Becomes the MAINSTREAM in PV Industry

String inverters grows rapidly worldwide

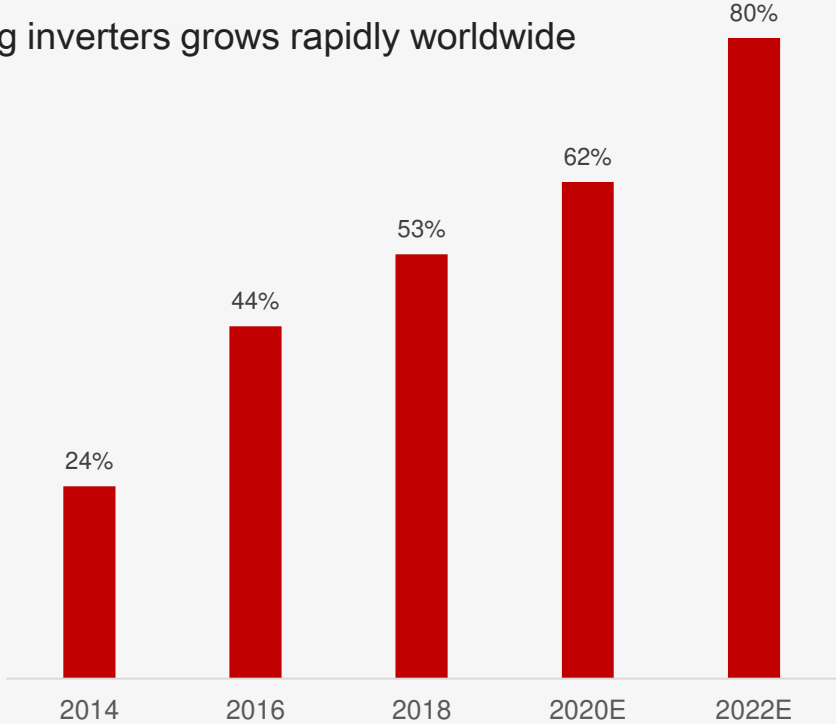

Data Source: Third Parity Consultant Company

Leading Smart String Solution for All PV Scenarios

Residential

2~6kW 3~10kW



Commercial & Industrial

12~20kW 30~40kW
50/60kW 100kW



Utility-scale

215kW 100kW



Smart & String for All PV Scenarios

01 Company
Introduction

02 FusionSolar Residential
Smart PV Solution

03 Summary

FusionSolar Residential Smart PV Solution



Optimal Electricity Cost



Active Safety



Better Experience



FusionSolar Residential Smart PV Solution

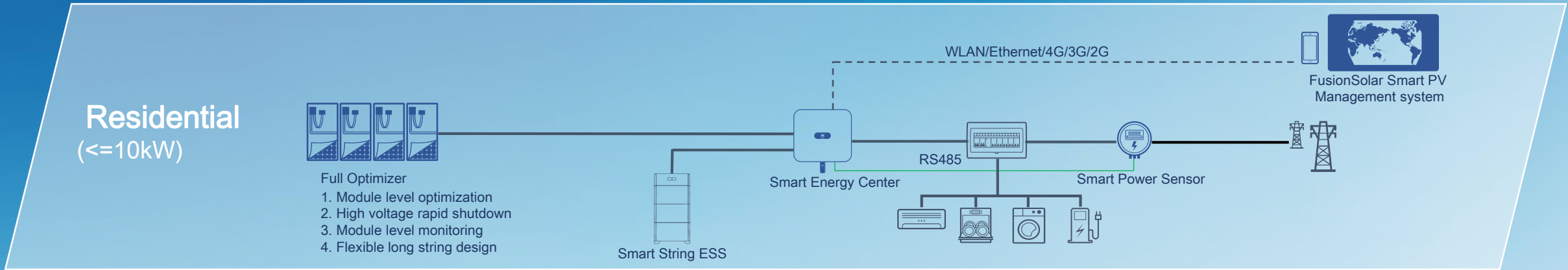

Smart Energy Center

SUN2000-2/3/3.68/4/4.6/5/6KTL-L1

Single Phase



Smart Energy Center

SUN2000-3/4/5/6/8/10KTL-M1

Three Phase



Smart String ESS

LUNA2000-5/10/15-S0

Support 2 ESS operating in parallel, up to 30kWh



Backup Box

Backup Box-B0/B1



Smart PV Optimizer

SUN2000-450W-P



Smart Dongle

Smart Dongle-WLAN-FE
Smart Dongle-4G



Smart Power Sensor

DDSU666-H (Single Phase)
DTSU666-H 250A (Three Phase)



Monitoring Portal

FusionSolar Cloud & APP



Optimal Electricity Cost

Active Safety

Better Experience

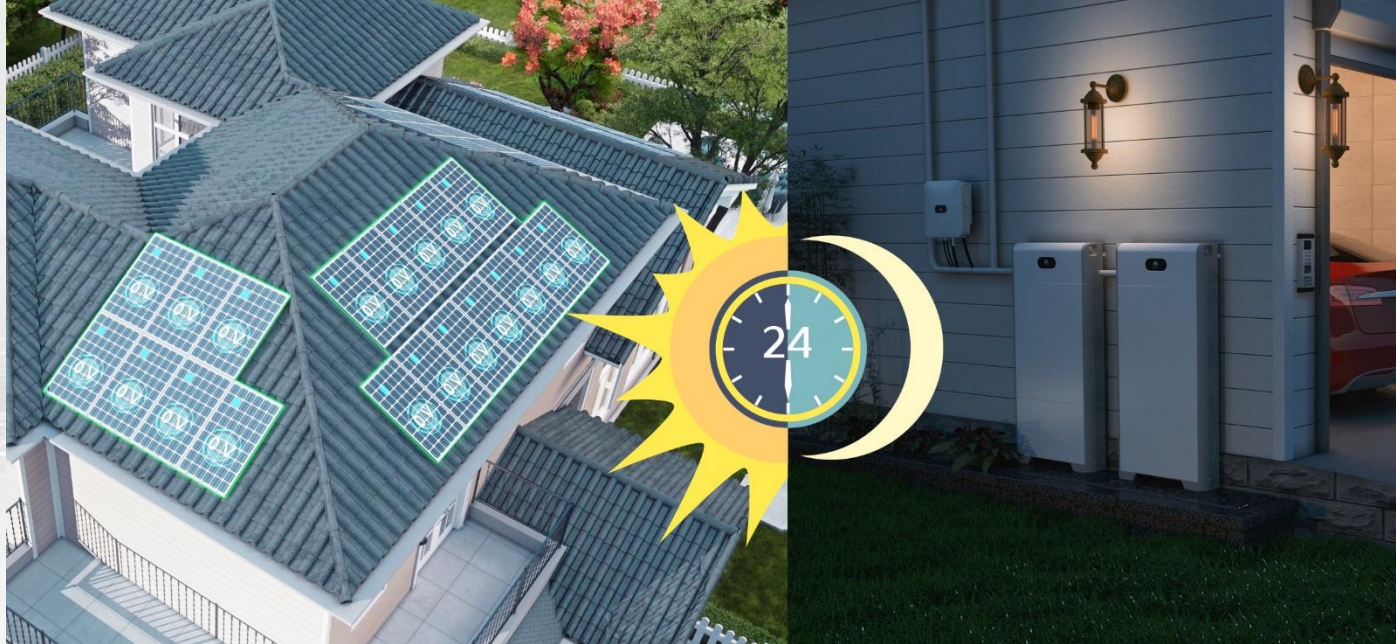

Generate more PV energy for
daytime consumption

Store more PV energy for
nighttime consumption

Maximized PV Power Self-Consumption

Up to 30%

More Energy by
Optimizing Each
Module's Performance

Without optimizer

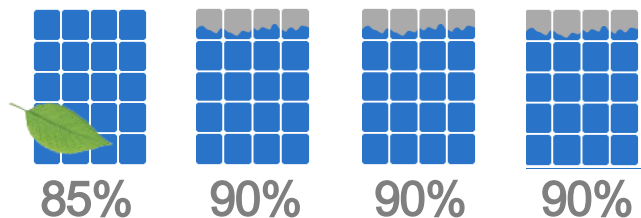

With optimizer

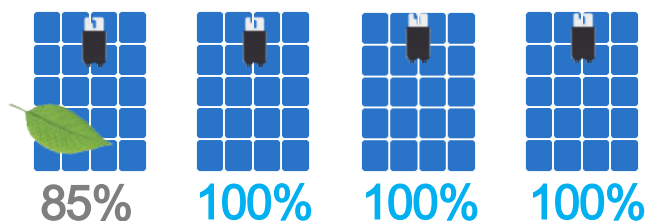

Shading

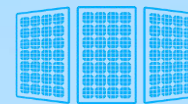

Different Azimuth



Different Tilt



Comparison Case of Energy Yields

Full optimizer system generates average **10%-13%** more energy per day than no optimizer system

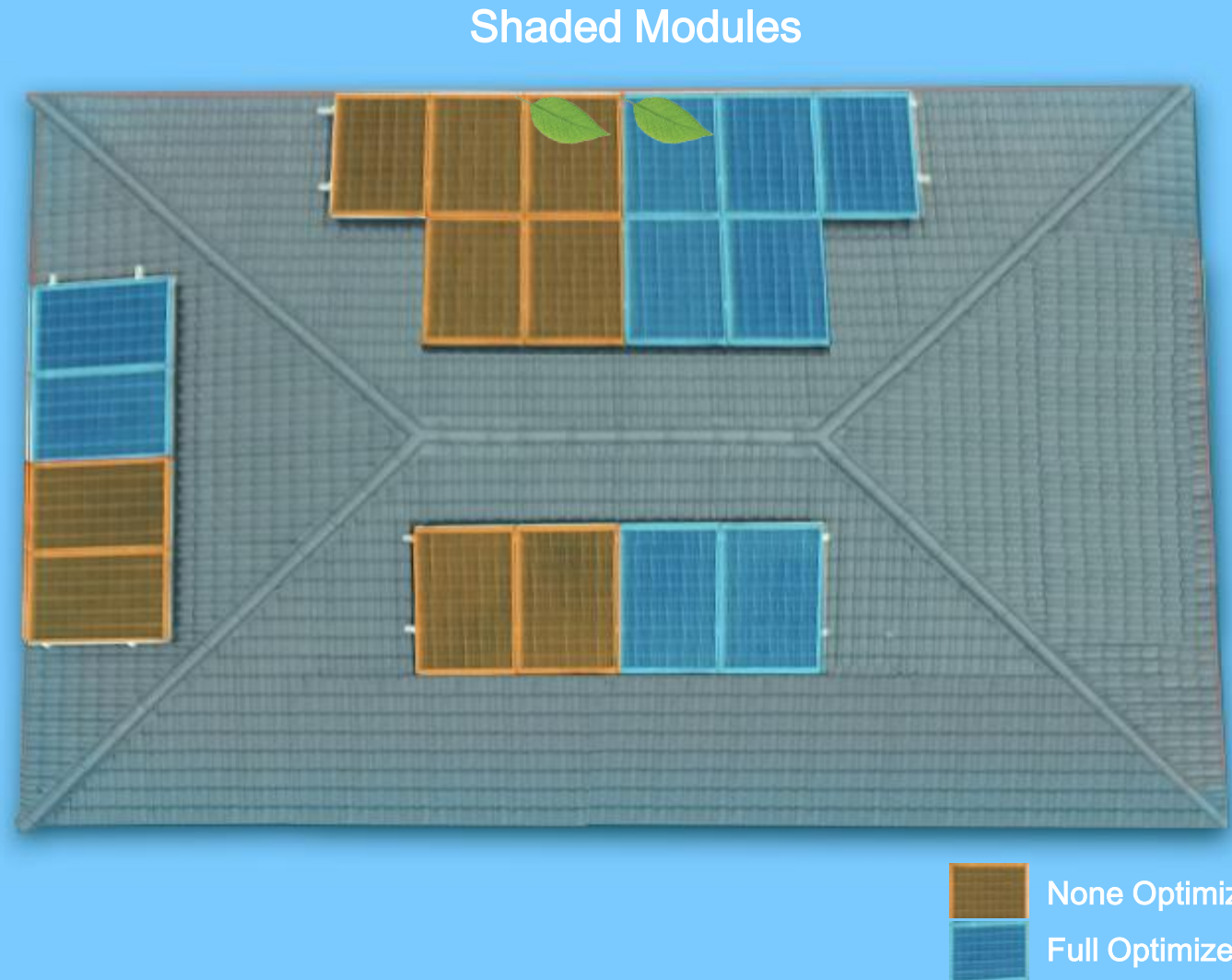
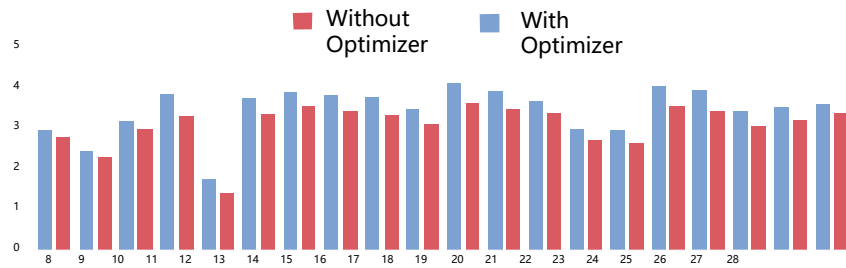

	No Optimizer	Full Optimizer
PV Module	2,205 Wp	2,205 Wp
Optimizer	N/A	9x SUN2000-450W-P
Inverter	1x SUN2000-2KTL-L1	1x SUN2000-2KTL-L1

More Modules

with Long & Flexible String Design

Comparison Case

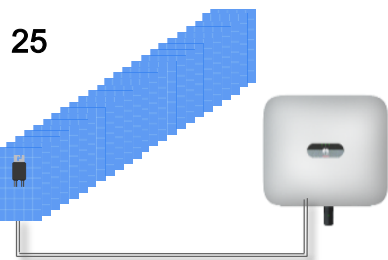
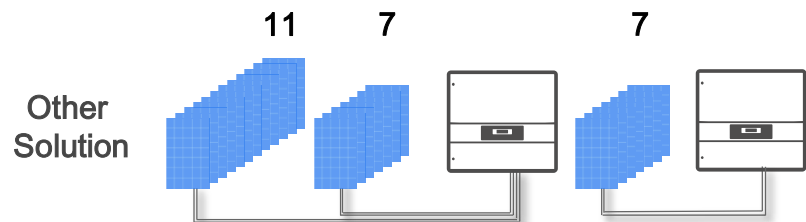

·Max. **200%** DC/AC oversizing for SUN2000- 5KTL-L1 & 10KTL-M1

	SUN2000-2-6KTL-L1	SUN2000-3-10KTL-M1
Maximum DC power per string	5,000 W	10,000 W



Smart String ESS

with Energy Optimizer



A string of battery modules for flexible expansion



Energy optimizer to manage charge/discharge per module independently, supports new and old battery module mixed in one system without usable energy restriction



LUNA2000-5/10/15-So
Smart String ESS Solution

Other Modular Battery



60%

60%

60%

60%

SOH SOC

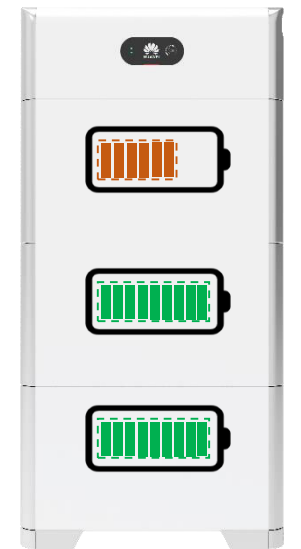

60%

100%

100%



5-30kWh ESS

50kg Battery Module

Easy for two people installation without extra lift tools

100% DoD

100% depth of discharge, use as much energy as you pay for

Parallel Operating

Supports Max 2 Storage System Operating in Parallel, 5-30kWh

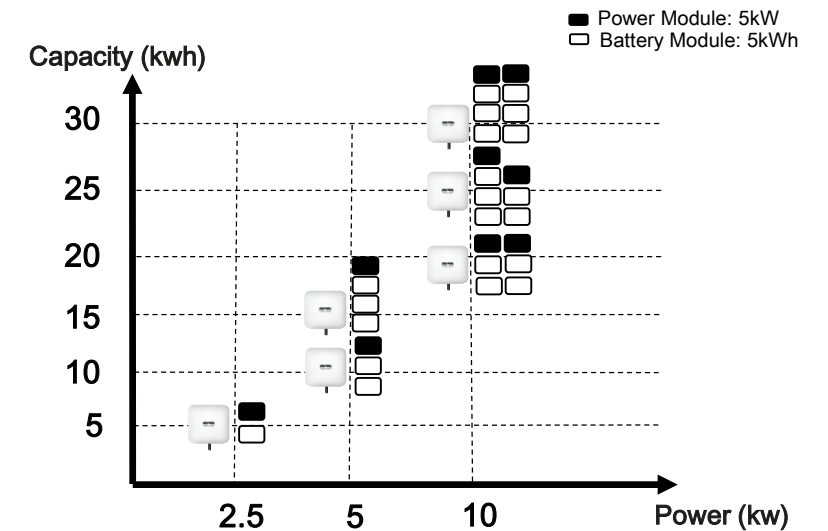

2x POWER

Battery Ready

For More Energy

A 5KTL inverter allows **5KW** full power AC output plus **5KW** full power battery charge.

More Daytime Consumption

- Inverter output full power for daytime energy consumption

More Nighttime Consumption

- Inverter charges ESS at full power for more nighttime energy consumption



Other PV + Storage Solution



10 KWp PV

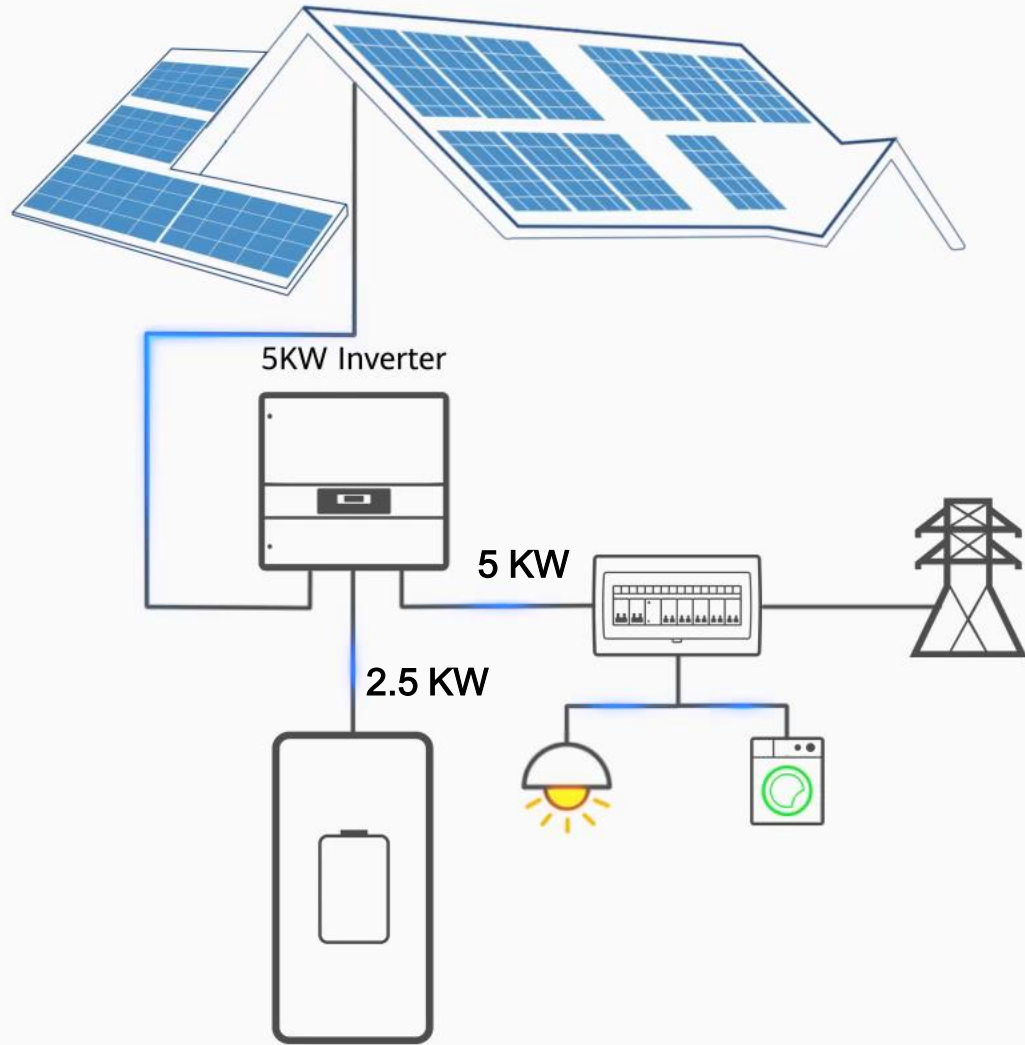

Battery Energy: 15 kWh

HUAWEI 2x POWER Battery Ready



10 KWp PV

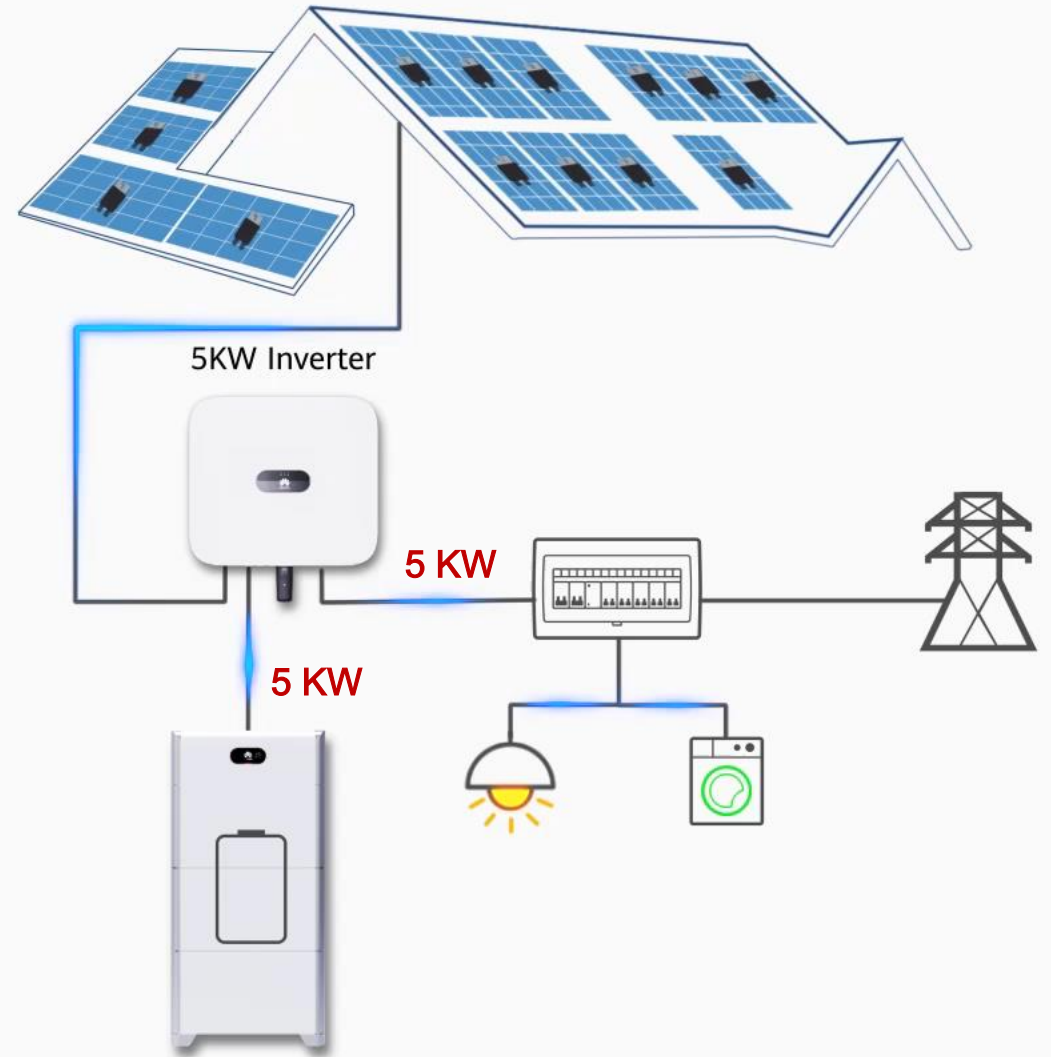

Battery Energy: 15 kWh



Optimal Electricity Cost

Active Safety

Better Experience

Electric Arcing Is Threatening the Safety of PV System & Underlying Buildings

What is it?

- electrical breakdown of air that produces an prolonged electrical discharge

What causes Electric Arcing?

- Unreliable soldered joints within modules
- Broken PV cables
- Loosen PV connectors

What is the harm?



Can reach temperature of over 3000°C & easily start a fire



Arc Detection Challenges



Arc noise is generally weak and only accounts for 0.1% of the normal current signal, it is difficult to detect and often leads to missing detection



Inverter/Loads/Grid interference signals, as well as spectral overlay with normal current signal leads to faulty detection

AI Powered

Active Arcing Protection

What is AI Powered AFCI?

- HUAWEI inverter keeps self-learning new arc feature to accurately protect system from arc fault, even under complex noise



Self-learning new arc features with AI model



Accurate arc fault detection via local neural network algorithm



Speedy arc fault protection by inverter shutdown in 0.5s

Arc Feature
Self-learning

Accurate Arc
Fault Detection

Speedy Arc
Fault Interruption

Pinpoint Arc
Fault Positioning

AFCI disabled, arcing continuously posing fire risks



VS

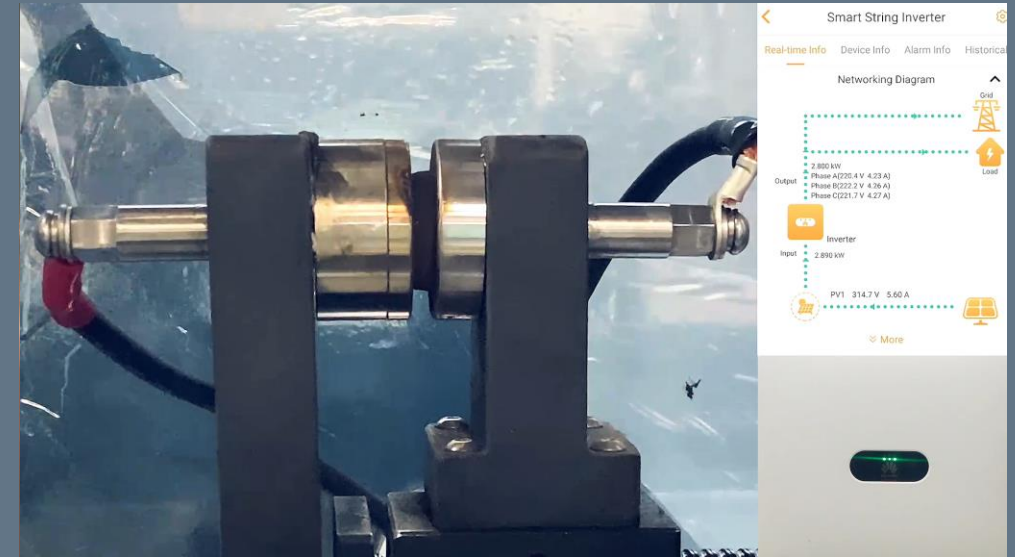

AFCI function enabled, arcing extinguished in < 0.5sec

PV Arcing with/without AFCI Comparison



Safe House

with Smart PV Optimizer

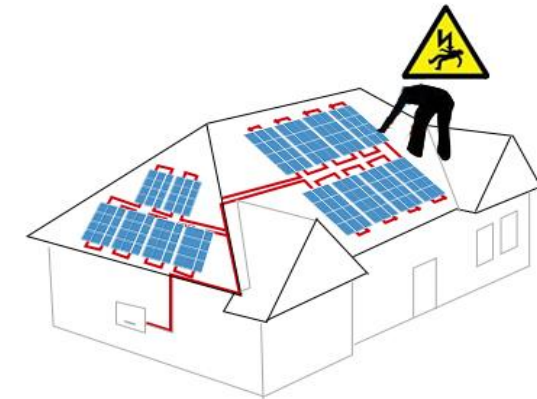

Without optimizer: High DC voltage when system shuts down

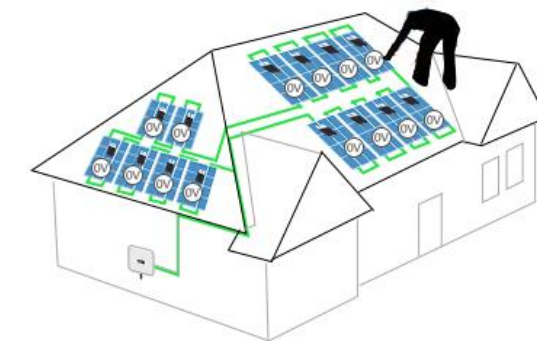

With optimizer: Each optimizer outputting 0V when system shuts down



Pinpoint

Arc Fault Positioning for Easier Troubleshooting

 Saving 80% onsite troubleshooting time and cost with accurate arc fault positioning

* Manually detection of DC arc fault in a 10KWp residential system usually costs 5hrs. Pinpoint arc fault position report lead to resolve the problem within 30 mins.

 Less power loss because of shorter system tripping



3-Layer Protection

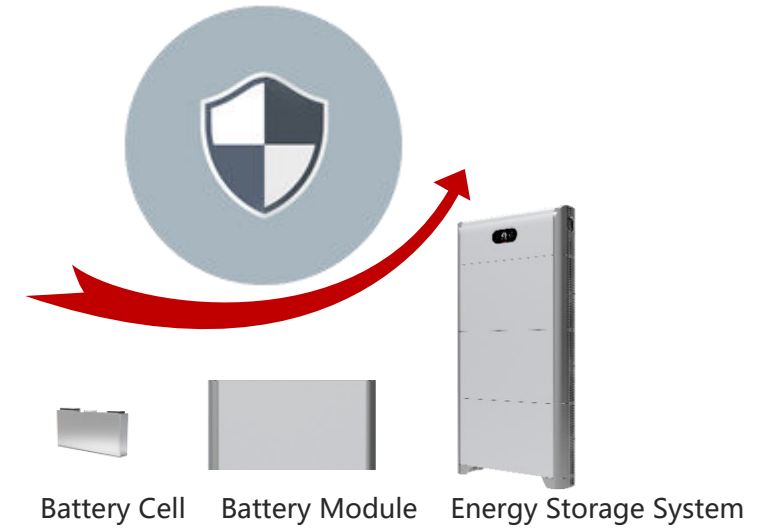

Cell Level Protection

- Lithium iron phosphate cell for safe and stable performance

Pack Level Protection

- 8 sensors per pack to supervise operating status

10kWh Battery	HUAWEI	A	B
Sensors per pack	3 x 8 = 24	3	4 x 4 = 16

System Level Protection

- Faulty pack auto isolation, touch safe
- Compliance to the most rigorous safety standard VDE2510

No Worry About Power Outage

With Backup Power



System switches to backup mode to supply emergent power to critical load automatically when power outage



Smart string ESS supports black start from blackout to restore system operating

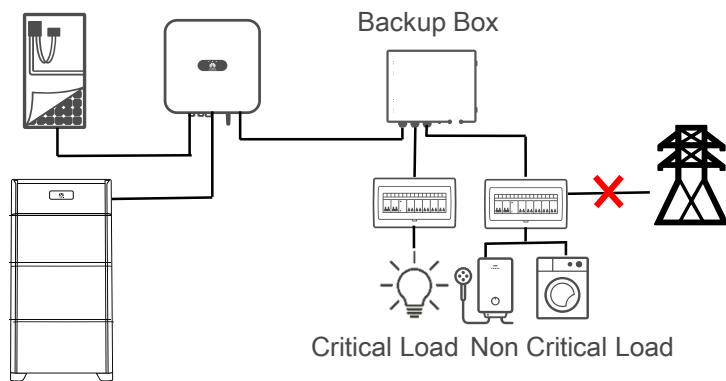

An aerial photograph of a solar farm, showing a vast grid of solar panels stretching across a landscape. The scene is partially obscured by large, white, fluffy clouds in the foreground and middle ground, creating a sense of depth and atmosphere. The overall color palette is soft and light, dominated by whites, greys, and muted greens.

Optimal Electricity Cost

Active Safety

Better Experience

Sleek Design - Waterfall



Smart String ESS
LUNA2000-15-S0

Sleek Design -
Snowbergs surround the lake



Smart Energy Center
SUN2000-2-5-KTL-L1

One-Fits-All

Solution, Easier Business

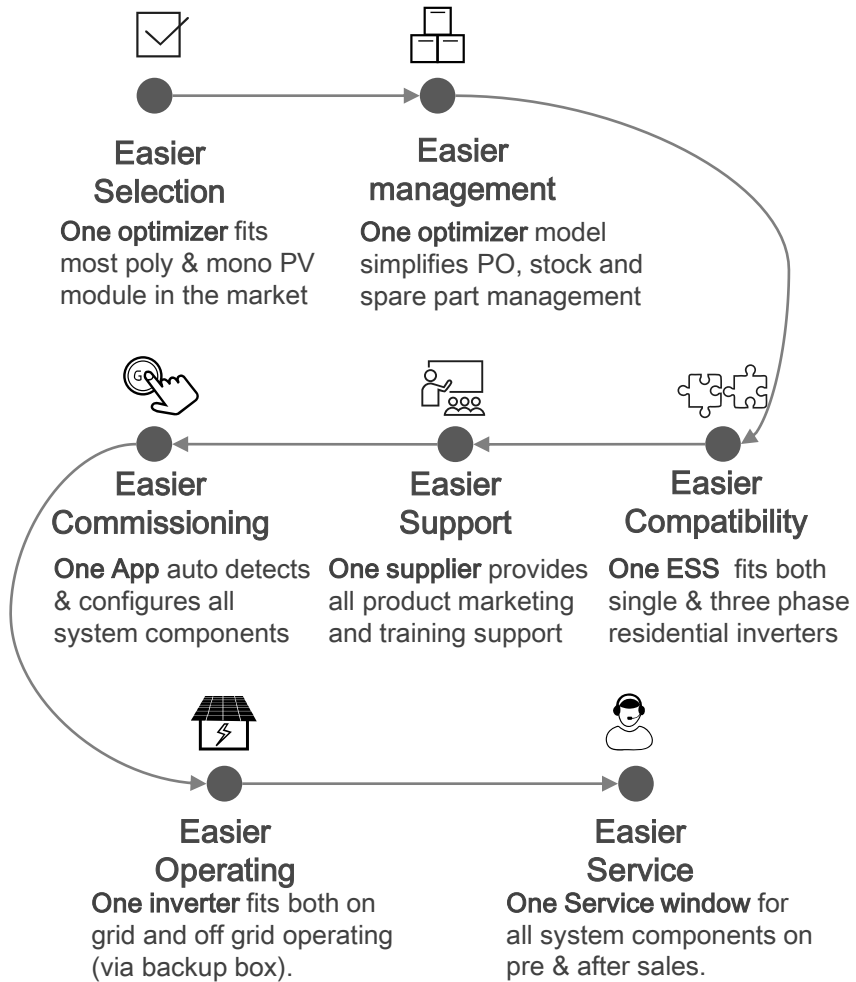

Auto Detection of All System Devices

All inverter connected devices can be automatically detected in FusionSolar app

	HUAWEI Solution	Other Solution
System Setting up Duration	1.5-3 mins (Device Auto Detected in App)	15-20 mins (Seperated Apps or web tools to add devices manually)

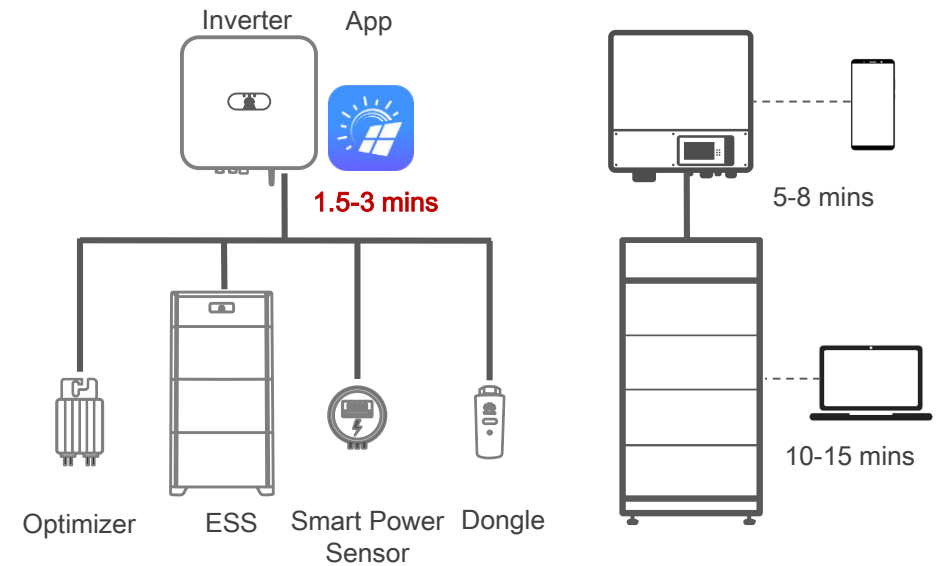
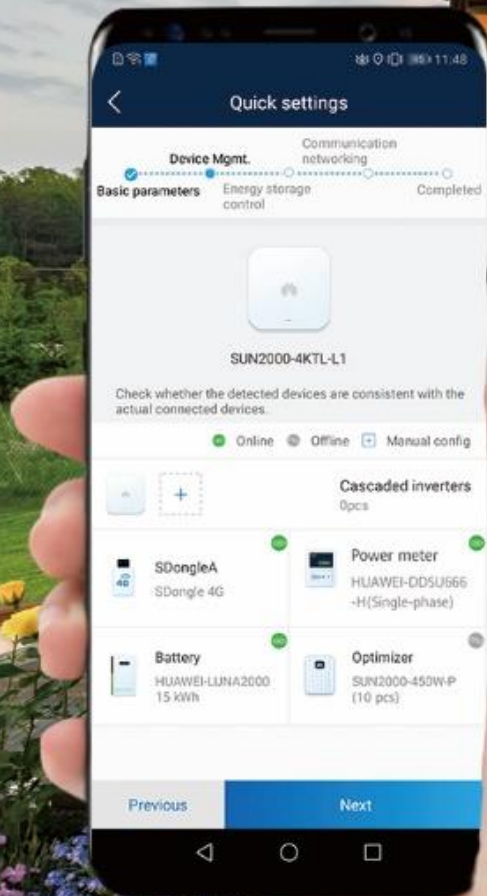

<5sec

Module Auto-Mapping

Operating Steps	HUAWEI Solution	Other Solutions
2D barcode paste on template	Same	Same
Physical layout creation	<5sec (AI powered)	6.5min (manual)
Total configuration time	<1min	6.5min

@15KW system with 40 pcs of PV modules

Saving **86%** configuration time compared with other solutions

Flexible Communication & Power Control for All Scenarios



WLAN-FE Dongle

2 in 1 smart dongle, flexible communication option at Home



4G Dongle

Independent and stable operation, without location and communication constraints



Social Housing



Power Purchase Agreement



Apartment Roof

No Fuse or Other Quick-wear Parts,
Inverter Touch Free



No Fuse



No LCD



No Button

Natural Cooling Verified by
Telecom & Solar Application*



* For 3-10KTL inverter models

TUV verified: annual failure rate < 0.5%
Inverter availability up to 99.996%

Station Phase II,
200 units, 963 running days

Failure Rate:
0.189%

Station Phase III,
4939 units, 583 running days

Failure Rate:
0.252%

Station Phase IV,
1790 units, 207 running days

Failure Rate:
0.390%



High efficient thermal design
to ensure low temperature
within enclosure



- **Visible Power Flow**
- **Module-Level Monitoring**
- **Statistical Indicator**



Real-Time Power Flow

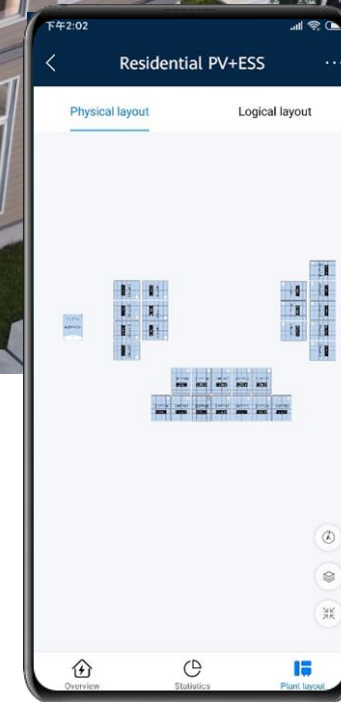

Module Level Monitoring

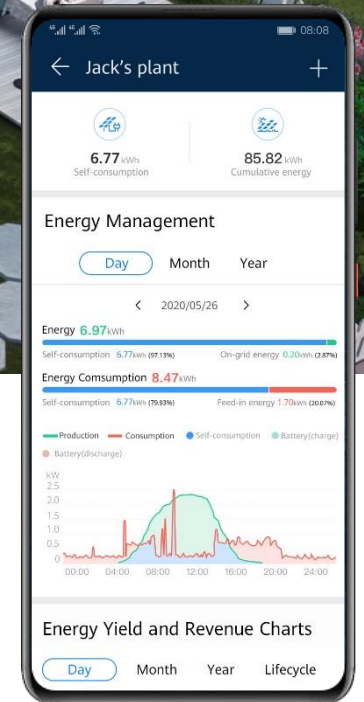

Self-Consumption & Sufficiency Indicator



50% Smaller

Palm Fit for Comfortable Holding, Thanks to Compact Design Philosophy

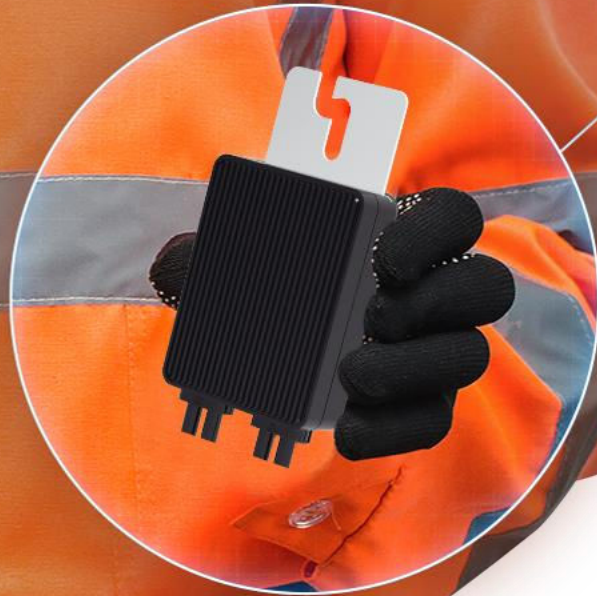

50%

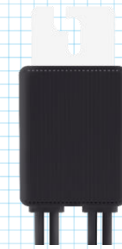

0.24L

(71x138x25mm)

Huawei 2nd Gen.



0.47L

(125x150x25.2mm)

Huawei 1st Gen.

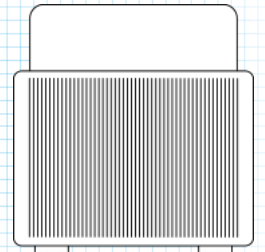

0.54L

(128x152x28mm)

Similar Optimizer

Screw-less

Innovative AC and Comm.
Port for Easier Connection



Free of uncovering for better protection and higher reliability



Screw-less wiring and directly bolt-in in only 10s



Standardized wiring to eliminate mis-operation, safe & reliable



01 Company
Introduction

02 FusionSolar Residential
Smart PV Solution

03 Summary

Nine Innovative Features of Solution

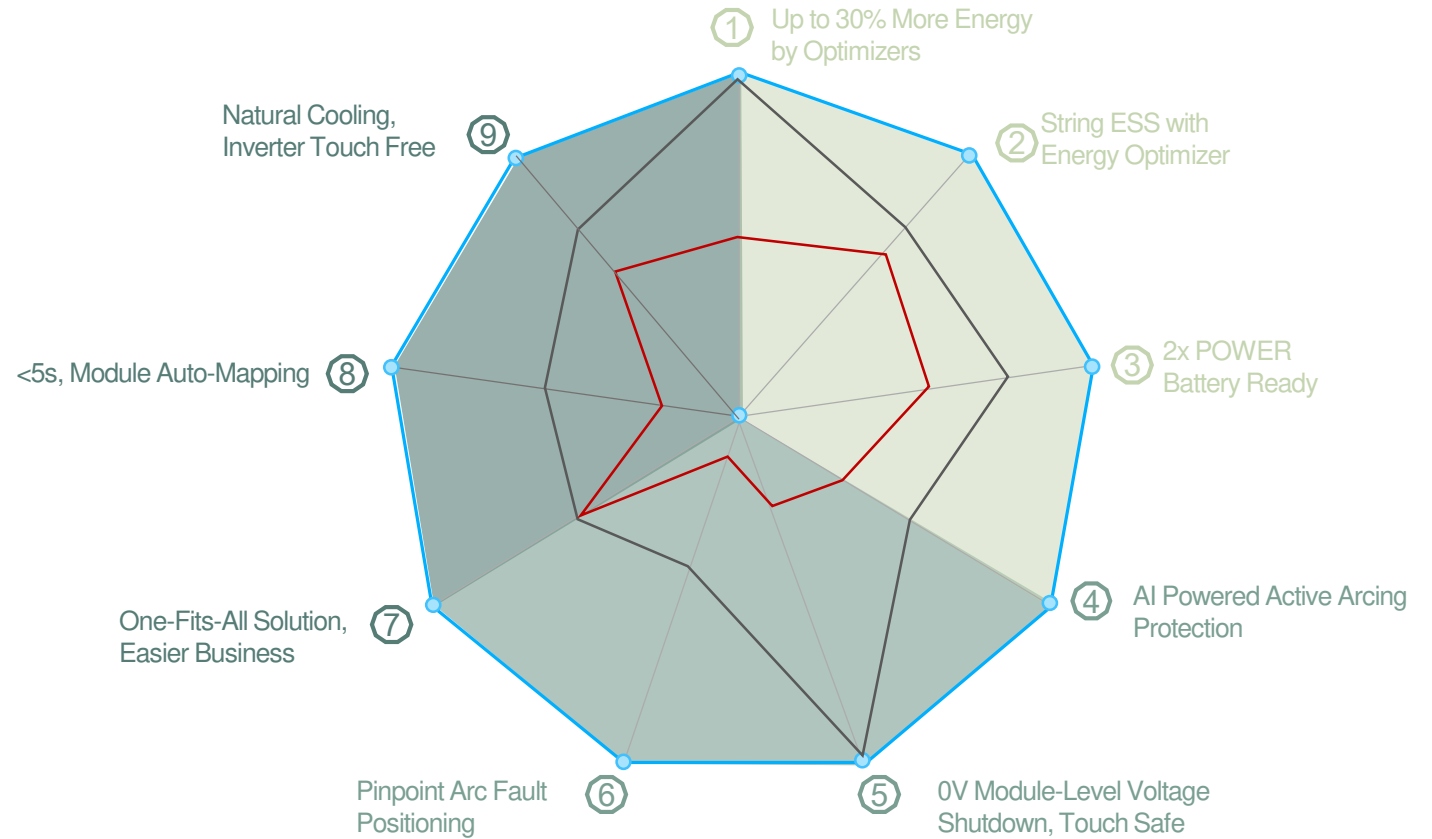
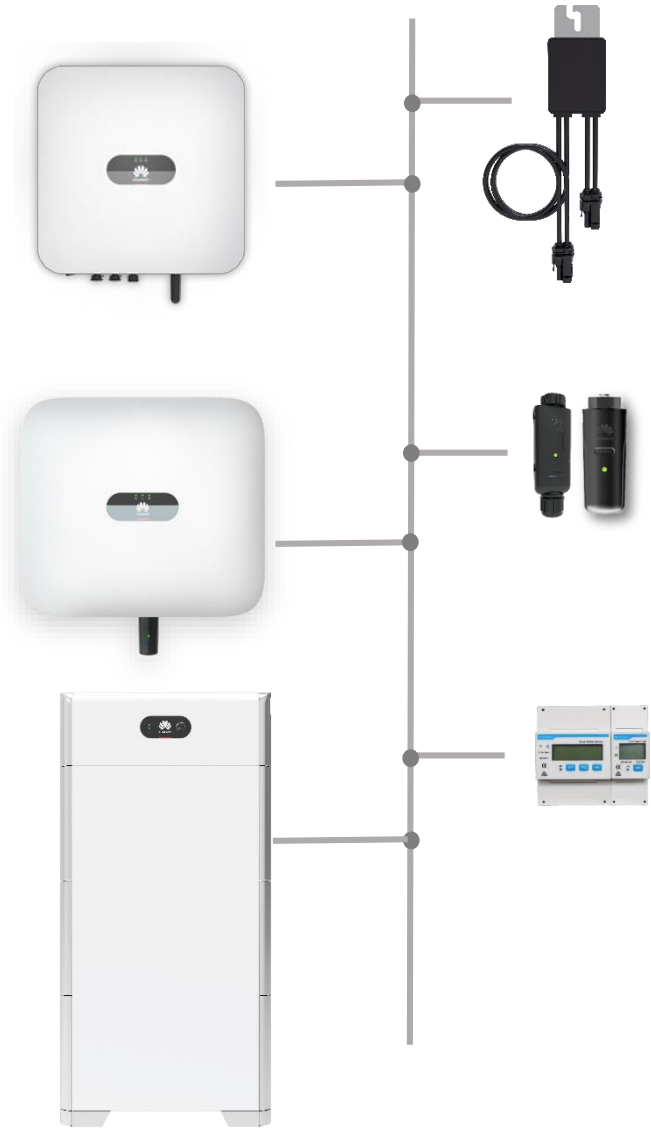

- Huawei Solution
- A Other Optimizer Solutions
- B Other Inverter Solutions

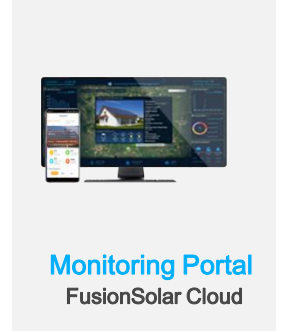
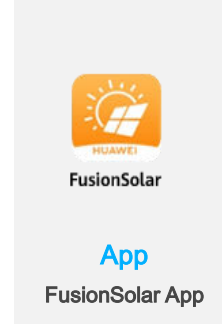
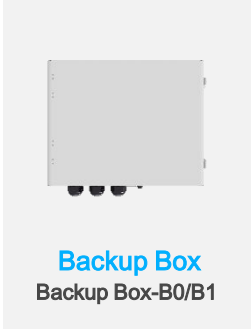
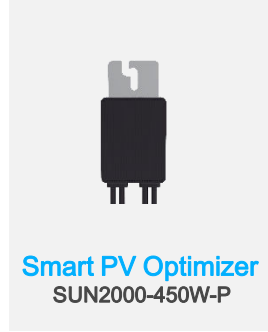
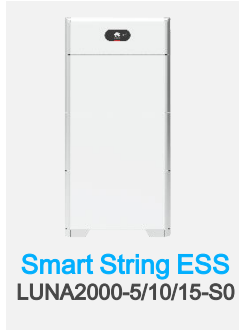
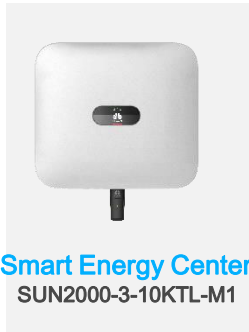
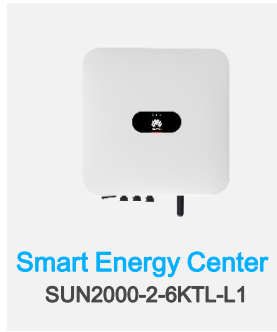

Main Feature Difference	SUN2000L-2-5KTL	SUN2000-2-5KTL-L0	SUN2000-2-6KTL-L1	SUN2000-3-10KTL-M0	SUN2000-3-10KTL-M1
Available Time for Shipment	Already Available	Already Available	Already Available	Already Available	Already Available
Compatible with HUAWEI new optimizer SUN2000-450W-P			√		√
LG Chem battery compatible	√		√		
HUAWEI LUNA2000 string battery compatible	√ *		√	√ *	√
WLAN-FE dongle compatible			√	√	√
4G dongle compatible		√	√	√	√
Active arc fault protection			√	√	√
Pinpoint arc fault positioning			√		√
Integrated PID recovery					√
Backup function availability			√ *		√ *

* Available in 2021 Q1

Thank you.

把数字世界带入每个人、每个家庭、
每个组织，构建万物互联的智能世界。

Bring digital to every person, home, and
organization for a fully connected,
intelligent world.

**Copyright©2018 Huawei Technologies Co., Ltd.
All Rights Reserved.**

The information in this document may contain predictive statements including, without limitation, statements regarding the future financial and operating results, future product portfolio, new technology, etc. There are a number of factors that could cause actual results and developments to differ materially from those expressed or implied in the predictive statements. Therefore, such information is provided for reference purpose only and constitutes neither an offer nor an acceptance. Huawei may change the information at any time without notice.

