

FusionSolar App and SUN2000

App User Manual

Issue 02
Export Date 2021-11-30



Copyright © Huawei Technologies Co., Ltd. 2021. All rights reserved.

No part of this document may be reproduced or transmitted in any form or by any means without prior written consent of Huawei Technologies Co., Ltd.

Trademarks and Permissions



HUAWEI and other Huawei trademarks are trademarks of Huawei Technologies Co., Ltd.

All other trademarks and trade names mentioned in this document are the property of their respective holders.

Notice

The purchased products, services and features are stipulated by the contract made between Huawei and the customer. All or part of the products, services and features described in this document may not be within the purchase scope or the usage scope. Unless otherwise specified in the contract, all statements, information, and recommendations in this document are provided "AS IS" without warranties, guarantees or representations of any kind, either express or implied.

The information in this document is subject to change without notice. Every effort has been made in the preparation of this document to ensure accuracy of the contents, but all statements, information, and recommendations in this document do not constitute a warranty of any kind, express or implied.

Huawei Technologies Co., Ltd.

Address: Huawei Industrial Base
Bantian, Longgang
Shenzhen 518129
People's Republic of China

Website: <https://e.huawei.com>

About This Document

Overview

This document describes the common operations of the FusionSolar app.





Intended Audience

This document is intended for:

- Installers
- Users

Symbol Conventions

The symbols that may be found in this document are defined as follows.

Symbol	Description
 DANGER	Indicates an imminently hazardous situation which, if not avoided, will result in death or serious injury.
 WARNING	Indicates a potentially hazardous situation which, if not avoided, could result in death or serious injury.
 CAUTION	Indicates a potentially hazardous situation which, if not avoided, may result in minor or moderate injury.
 NOTICE	Indicates a potentially hazardous situation which, if not avoided, could result in equipment damage, data loss, performance deterioration, or unanticipated results. NOTICE is used to address practices not related to personal injury.
 NOTE	Calls attention to important information, best practices and tips. NOTE is used to address information not related to personal injury, equipment damage, and environment deterioration.

Change History

Changes between document issues are cumulative. The latest document issue contains all the changes made in earlier issues.

02 (2021-11-30)

This issue is the second official release of SmartPVMS V500R007C00.

01 (2021-09-18)

This issue is the first official release of SmartPVMS V500R007C00.

Contents

About This Document	ii
1 Overview	1
1.1 Introduction to the App	1
1.2 Downloading and Installing the App	1
2 Operations on the FusionSolar APP	5
2.1 (Optional) Registering an Installer Account (When No Account Is Available)	5
2.2 Setup Wizard	6
2.3 How to View the PV plant overview	6
3 Commissioning Devices.....	10
4 Operations on the Screen for Connecting to the Distributed Solar Inverter	12
4.1 Distributed Solar Inverter	12
4.2 Login	13
4.3 Alarm Management	16
4.4 Quick Settings	16
4.5 Device Monitoring	17
4.6 Maintenance.....	17
4.7 Settings	19
4.8 Power Adjustment	34
5 Operations on the Screen for Connecting to the Commercial Solar Inverter	40
5.1 Commercial Solar Inverter.....	40
5.2 Connection Modes.....	43
5.3 Required Accessories.....	44
5.4 User Operation Permissions.....	45
5.5 Login	47
5.6 Screen Operations (Common User).....	51
5.6.1 Query	51
5.6.2 Settings	53
5.6.3 Maintenance	53
5.6.3.1 System Maintenance	53
5.6.3.2 Feedback	54
5.6.3.3 Help	55
5.6.3.4 About	55
5.7 Screen Operations (Advanced User).....	56
5.7.1 Query	56
5.7.2 Quick Settings	58

5.7.3 Settings	59
5.7.3.1 Setting Grid Parameters	60
5.7.3.2 Setting Protection Parameters.....	61
5.7.3.3 Setting Feature Parameters.....	61
5.7.3.4 Time setting.....	62
5.7.3.5 Setting Communications Parameters	64
5.7.3.6 Setting a Tracking System	65
5.7.3.7 Setting a File Save Path.....	67
5.7.4 Maintenance	67
5.7.4.1 Device Inspection	69
5.7.4.2 License Management	70
5.7.4.3 PV String Access Detection.....	71
5.7.4.4 Startup and Shutdown	72
5.7.4.5 Restoring Factory Settings	73
5.7.4.6 Resetting a Solar Inverter	73
5.7.4.7 Clearing Alarms.....	73
5.7.4.8 Clearing Historical Energy Yield Data.....	74
5.7.4.9 Importing and Exporting Configuration Files.....	74
5.7.4.10 Spot-Check.....	74
5.7.4.11 Device Upgrade	75
5.7.4.12 Log management	76
5.7.4.13 Changing the WLAN Password.....	77
5.7.4.14 Feedback	77
5.7.4.15 Help	78
5.7.4.16 About.....	78
5.8 Screen Operations (Special User).....	79
5.8.1 Query	79
5.8.2 Settings	81
5.8.2.1 Setting Grid Parameters	81
5.8.2.2 Setting Protection Parameters.....	82
5.8.2.3 Setting Feature Parameters.....	83
5.8.2.4 Setting Power Adjustment Parameters	84
5.8.2.5 Setting a File Save Path.....	85
5.8.3 Power Adjustment	85
5.8.4 Maintenance	85
.....	86
5.8.4.6 Startup and Shutdown	86
5.8.4.7 Restoring Factory Settings	86
5.8.4.8 Device Upgrade.....	87
5.8.4.9 Log management	87
5.8.4.10 Feedback	88
5.8.4.11 Help.....	89

5.8.4.12 About.....	89
6 Operations on the Screen for Connecting to the SmartLogger	91
6.1 SmartLogger	91
6.2 User Operation Permissions.....	92
6.3 Login	96
6.4 Screen Operations (Common User).....	99
6.4.1 Query.....	99
6.4.2 Settings	100
6.4.2.1 Setting the System Date and Time	101
6.4.2.2 Setting Plant Information	101
6.4.2.3 Setting Revenue Parameters.....	102
6.4.3 Maintenance.....	102
6.4.3.1 System Maintenance	102
6.4.3.2 Feedback	103
6.4.3.3 Help	104
6.4.3.4 About	105
6.4.4 Device Monitoring.....	106
6.4.4.1 Query	106
6.4.4.2 Maintenance	107
6.5 Screen Operations (Advanced User).....	107
6.5.1 Query	107
6.5.2 Device Monitoring.....	108
6.5.2.1 Query	108
6.5.2.2 Settings.....	109
6.5.2.3 Maintenance	110
6.5.2.3.1 Log Download.....	110
6.5.2.3.2 Solar Inverter Maintenance	110
6.5.2.3.3 MBUS Maintenance.....	111
6.5.2.3.4 PID Module Maintenance.....	111
6.5.3 Maintenance.....	111
6.5.3.1 System Maintenance	111
6.5.3.1.1 Changing a User Password.....	111
6.5.3.1.2 Generating the Local Maintenance Script	112
6.5.3.1.3 Offline Configuration.....	113
6.5.3.1.4 Resetting the System.....	114
6.5.3.1.5 Clearing Data.....	114
6.5.3.1.6 Importing and Exporting All Files	115
6.5.3.1.7 Restoring Factory Settings	116
6.5.3.2 Solar Inverter Inspection	117
6.5.3.3 Device Management	118
6.5.3.3.1 Changing a Device Name.....	118

6.5.3.3.2 Deleting Devices.....	119
6.5.3.3.3 Automatically Searching for Devices.....	119
6.5.3.3.4 Manually Adding a Device.....	120
6.5.3.3.5 Automatically Allocating Addresses.....	121
6.5.3.3.6 Importing Configuration.....	121
6.5.3.3.7 Exporting Configuration.....	122
6.5.3.3.8 Resetting Alarms.....	123
6.5.3.3.9 Starting, Shutting down, and Resetting Solar Inverters in Batches.....	124
6.5.3.3.10 Setting Access Parameter.....	124
6.5.3.4 Managing the Device List.....	125
6.5.3.5 Exporting Device Logs.....	126
6.5.3.6 Device Upgrade.....	126
6.5.3.7 Spot-Checking Solar Inverters.....	127
6.5.3.8 Feedback.....	128
6.5.3.9 Help.....	129
6.5.3.10 About.....	130
6.5.4 Settings.....	131
6.5.4.1 Setting the System Date and Time.....	132
6.5.4.2 Setting Plant Information.....	132
6.5.4.3 Setting Revenue Parameters.....	133
6.5.4.4 Setting Ethernet Parameters.....	133
6.5.4.5 Setting RS485 Parameters.....	134
6.5.4.6 Setting Modbus-RTU Power Meter Parameters.....	135
6.5.4.7 Setting Management System Parameters.....	135
6.5.4.8 Setting Modbus TCP Parameters.....	137
6.5.4.9 Setting IEC103 Device Parameters.....	137
6.5.4.10 Setting IEC104 Device Parameters.....	138
6.5.4.11 Remotely Shutting Down Solar Inverters in Dry Contact Mode.....	139
6.5.4.12 Setting FTP Parameters.....	139
6.5.4.13 Setting Email Parameters.....	140
6.5.4.14 Setting a File Save Path.....	141
6.5.5 Power adjustment.....	142
6.5.5.1 Active Power Control.....	142
6.5.5.2 Setting Reactive Power Control.....	142
6.6 Screen Operations (Special User).....	143
6.6.1 Query.....	143
6.6.2 Settings.....	144
6.6.2.1 Setting RS485 Parameters.....	144
6.6.2.2 Setting Modbus-RTU Power Meter Parameters.....	145
6.6.3 Maintenance.....	145
6.6.3.1 Solar Inverter Inspection.....	145
6.6.3.2 System Maintenance.....	146

6.6.3.2.1 Changing a User Password	146
6.6.3.2.2 Resetting the System	147
6.6.3.2.3 Clearing Data	148
6.6.3.2.4 Generating the Local Maintenance Script	149
6.6.3.2.5 Restoring Factory Settings	150
6.6.3.3 Device Management	151
6.6.3.3.1 Changing a Device Name	151
6.6.3.3.2 Deleting Devices	152
6.6.3.3.3 Automatically Searching for Devices	153
6.6.3.3.4 Manually Adding a Device	154
6.6.3.3.5 Automatically Allocating Addresses	155
6.6.3.3.6 Importing Configuration	155
6.6.3.3.7 Exporting Configuration	156
6.6.3.3.8 Resetting Alarms	157
6.6.3.3.9 Starting, Shutting down, and Resetting Solar Inverters in Batches	157
6.6.3.3.10 Setting Access Parameter	158
6.6.3.4 Managing the Device List	159
6.6.3.5 Exporting Device Logs	159
6.6.3.6 Device Upgrade	160
6.6.3.7 Spot-Checking Solar Inverters	161
6.6.3.8 Feedback	162
6.6.3.9 Help	163
6.6.3.10 About	164
6.6.4 Device Monitoring	165
6.6.4.1 Query	165
6.6.4.2 Settings	166
6.6.4.3 Maintenance	166
6.6.4.3.1 Log Download	166
6.6.4.3.2 Solar Inverter Maintenance	167
7 Operations on the Screen for Connecting to the PID Module	168
7.1 PID Module	168
7.2 Required Accessories	169
7.3 User Operation Permissions	169
7.4 Login	171
7.5 Screen Operations (Common User)	174
7.5.1 Query	174
7.5.2 Settings	175
7.5.3 Maintenance	176
7.5.3.1 Feedback	176
7.5.3.2 Help	177
7.5.3.3 About	178

7.6 Screen Operations (Advanced User).....	179
7.6.1 Query	179
7.6.2 Settings	181
7.6.2.1 Setting Protection Parameters.....	181
7.6.2.2 Setting Feature Parameters.....	182
7.6.2.3 Setting User Parameters	184
7.6.2.4 Setting Communications Parameters	185
7.6.2.5 Setting a File Save Path.....	185
7.6.3 Maintenance	186
7.6.3.1 Log Download.....	186
7.6.3.2 System Maintenance	187
7.6.3.3 Device Upgrade.....	188
7.6.3.4 Feedback	188
7.6.3.5 Help	190
7.6.3.6 About	190
7.7 Screen Operations (Special User).....	191
7.7.1 Query	191
7.7.2 Settings	193
7.7.2.1 Setting User Parameters	193
7.7.2.2 Setting a File Save Path.....	193
7.7.3 Maintenance	194
7.7.3.1 Log Download.....	194
7.7.3.2 System Maintenance	195
7.7.3.3 Device Upgrade.....	195
7.7.3.4 Feedback	196
7.7.3.5 Help	197
7.7.3.6 About	198
8 SUN2000 APP Tool Kit.....	200
8.1 File download.....	200
8.2 MBUS Whitelist.....	201
8.3 Local Maintenance Script	204
8.3.1 Solar Inverter Maintenance Script	204
8.3.2 SmartLogger Maintenance Script.....	205
8.4 File Management.....	206
8.5 About	206
9 Troubleshooting.....	208
10 FAQs.....	211
10.1 1.1 How Do I Use a Phone to Scan the QR Code to Download the FusionSolar App	211
10.2 Setting the Email on the Mobile Phone.....	213
10.3 Changing the App Login Password	217
10.4 How Do I Set a User-Defined Grid Code.....	217

10.5 How Do I Fix WLAN Connection Failure	218
10.6 IPS Check (for Italy CEI0-21 Grid Code Only)	219
10.7 How Do I Import a Grid Code?	221
10.8 How Do I Change the SSID and Password of the SmartLogger Built-in WLAN?	221
10.9 What Can I Do If My Phone Fails to Connect to a WLAN After I Scan the QR Code?	222
A Commercial Smart Inverters Parameters	223
B Domain Name List of Management Systems	244
C Public URLs.....	246
D Acronyms and Abbreviations.....	247

1 Overview

1.1 Introduction to the App

Introduction to the FusionSolar app

The FusionSolar app is the software used to manage PV plants. The app allows you to create PV plants, query alarms, manage devices, and perform routine maintenance.

Introduction to the SUN2000 app

The SUN2000 app is a mobile application that communicates with commercial solar inverters or PID modules over WLAN/Bluetooth or a USB data cable, communicates with the SmartLogger over WLAN/Bluetooth, and communicates with distributed solar inverters over WLAN. The app allows you to query alarms, configure parameters, and perform routine maintenance. It is a convenient platform for maintenance. The app name is displayed as **SUN2000**.

 **NOTE**

The FusionSolar app integrates the functions of the SUN2000 app. You can use these functions without installing the SUN2000 app. For details, see [3 Commissioning Devices](#).

1.2 Downloading and Installing the App

Downloading and Installing the FusionSolar app

NOTICE

- If the FusionSolar app version is 2.6.2 or earlier, upgrade the app version. Otherwise, the FusionSolar app functions cannot be used.
- The latest Android version is required for local commissioning. The iOS version is not updated and can be used only for viewing PV plant information. You can search for "FusionSolar" in App Store to download the iOS version.
- Delivering a restart, factory reset, shutdown, or upgrade command to the solar inverters may cause power grid connection failure, which affects the energy yield.
- Only professionals are allowed to set the grid parameters, protection parameters, feature parameters, power adjustment parameters, and grid-tied point control parameters of the solar inverters. If the grid parameters, protection parameters, and feature parameters are incorrectly set, the solar inverters may not connect to the power grid. If the power adjustment parameters and grid-tied point control parameters are incorrectly set, the solar inverters may not connect to the power grid as required. In these cases, the energy yield will be affected.

Method 1: Search for FusionSolar in Huawei AppGallery to download and install the app.

Method 2: Access <https://solar.huawei.com> using the mobile phone browser and download the latest installation package.

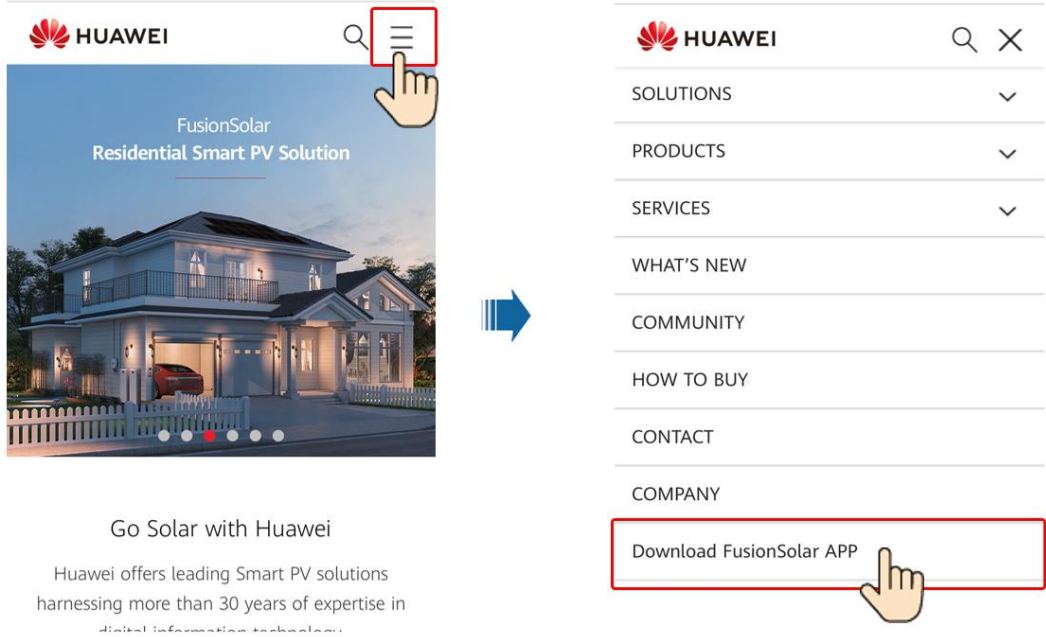

Method 3: Scan the QR code to download and install the app.



 **NOTE**

- Mobile phone operating system: Android 4.8, iOS 9.0 or later.
- Recommended phone brands: Huawei and Samsung, iOS terminals support iPhone 6 and later models (iPhone SE is not supported).
- The mobile phone supports the access to the Internet over a web browser.
- WLAN supported.
- The router supports WLAN (IEEE 802.11 b/g/n, 2.4 GHz) and the WLAN signal reaches the inverters.
- The WPA, WPA2, or WPA/WPA2 encryption mode is recommended for routers. The Enterprise mode is not supported (such as airport WLAN and other public hotspots that require authentication). WEP and WPA TKIP are not recommended because they have serious security vulnerabilities. If the access fails in WEP mode, log in to the router and change the encryption mode of the router to WPA2 or WPA/WPA2.

Downloading and Installing the SUN2000 app

NOTICE

The SUN2000 app will not be evolved in App Store (iOS) since 2.2.00.050. For new products and functions, use 3.2.00.002 or later versions in the Android system.

You can search for **SUN2000** in the Huawei AppGallery or scan the corresponding QR code (<https://solar.huawei.com/~media/Solar/APP/SUN2000.apk>), download the SUN2000 app installation package. After the installation package is downloaded, tap **Install** to install the app as instructed. The app can automatically prompt users to update the app version.



2 Operations on the FusionSolar APP

2.1 (Optional) Registering an Installer Account (When No Account Is Available)

- If your company has not registered a user, creating the first installer account.

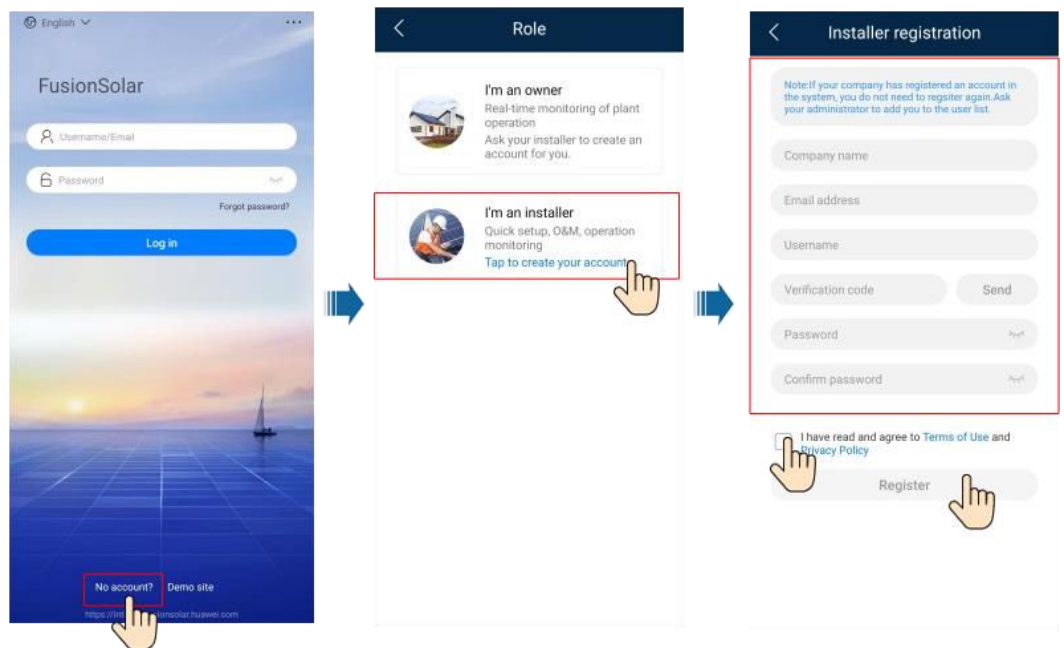

NOTE

Both the email address and username can be used to log in to FusionSolar app.

- To create multiple installer accounts for a company, log in to the app and create an installer account by choosing **New User**.

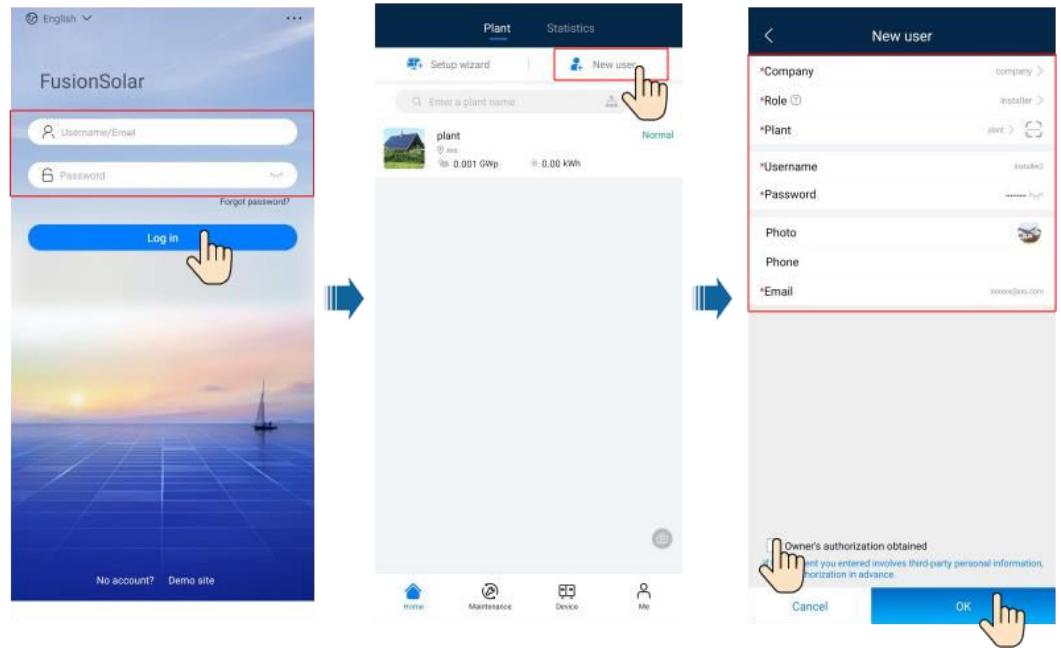

2.2 Setup Wizard

NOTE

- Use the initial password upon first power-on and change it immediately after login. To ensure account security, change the password periodically and keep the new password in mind. Not changing the initial password may cause password disclosure. A password left unchanged for a long period of time may be stolen or cracked. If a password is lost, devices cannot be accessed. In these cases, the user is liable for any loss caused to the PV plant.

For details about how to set the setup wizard, see the *FusionSolar App Quick Guide*.

2.3 How to View the PV plant overview

Log in to the FusionSolar app and go to the home screen to learn about the PV plant overview.

Permission

- After you log in to the app, you have the following permissions: **Home, O&M, Device, and Me**. If a user is not assigned with a certain permission, the user cannot perform corresponding operations after logging in to the app.
- After you create an account and log in to the app for the first time, read the privacy policy and tap **Confirm**. After a dialog box is displayed, change the login password to ensure account security.
- Before using the app on a mobile phone, ensure that the phone has the following permissions. Otherwise, the app cannot be used properly.
 - a. Permission to access a WLAN or 2G/3G/4G carrier network. This permission is required when you are using the app.
 - b. Permission to obtain user location information.

- After a mobile O&M engineer logs in to the app, the system reports the location information.
- When a mobile inspection task is started, the location information is reported before the task is stopped.
- When you add or modify a PV plant, the system obtains the current location information by default when you enter the PV plant location information.

NOTE

When the app is in use, the location function works, which will increase the power consumption.

- c. Permission to use the camera. You must have this permission if you want to take photos using the camera or upload photos from the photo album to the app.
- d. Permission to read, modify, or delete SD card content. You must have this permission to record logs of exceptions.

UI Description

After you log in to the app, the following screen is displayed. [Table 2-1](#) describes the screen. [Table 2-3](#) describes the icons on the home screen.

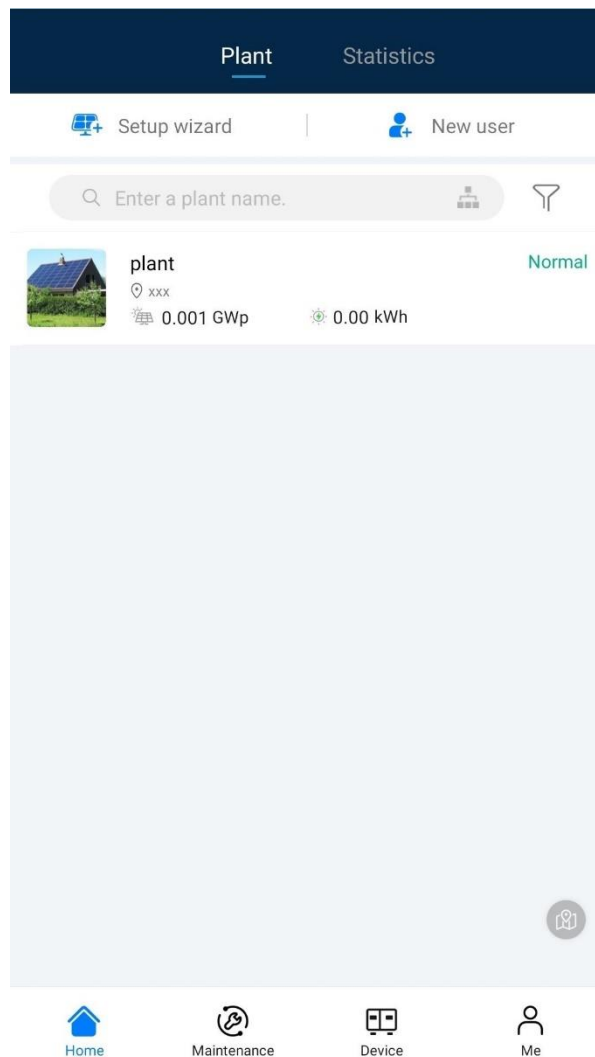









Table 2-1 UI description

Function	Description
Home	<p>On the Plant screen, tap a PV plant name to view its real-time information and the PV plant view.</p> <p>The Statistics screen displays the energy yield, revenue statistics, PV plant ranking on the current day, and social contribution.</p> <p>NOTE Yield and revenue statistics: Yield per hour: Yield value of all inverters in the next hour – Yield value of all inverters in the previous hour Revenue per hour: Yield per hour x Electricity price at that time Daily/Monthly report data statistics to the previous hour Annual/Lifetime report data statistics to the previous day</p>
O&M	The O&M screen displays the PV plant status, device alarms, diagnosis warning, online diagnosis, I-V curve, and mobile O&M.
Device	The Device screen displays the device information, and is used to set device parameters and replace devices.
Me	The Me screen displays the user information, messages, local commissioning tool, PV plant management, owner management, company information, and personal settings.

Table 2-2 Description of the energy flow diagram

Parameter	Description	Parameter	Description
PV	Indicates the PV strings. The generated electricity is equal to the PV string power.	Inverter	Converts DC power generated by PV strings into AC power.
Battery	Stores the remaining power.	Power Load	Indicates the power consumption of the PV plant. Power load = Output power – On-grid power.
Meter	Indicates the AC power distribution unit.	Grid	Indicates the low-voltage power grid.
Output	Indicates the output power of the solar inverter.	On-grid Power	Indicates the output power of the PV plant. $PV \text{ string power} \geq \text{On-grid power} + \text{Battery power}$

Table 2-3 Icons on the home screen

Icon	Description
	Tap  to create a PV plant.
	Tap  to add a user.
	Tap  to view the PV plant distribution on a map.
	Tap  to filter the PV plants to be displayed.

3 Commissioning Devices

Access device commissioning:

Method 1: (FusionSolar App) mobile phone connected to the Internet

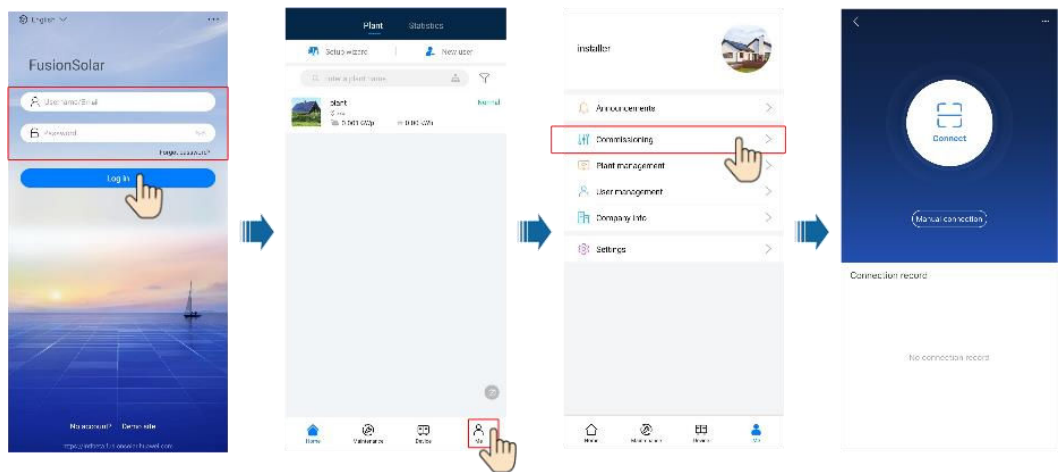

Method 2: (FusionSolar App) mobile phone not connected to the Internet

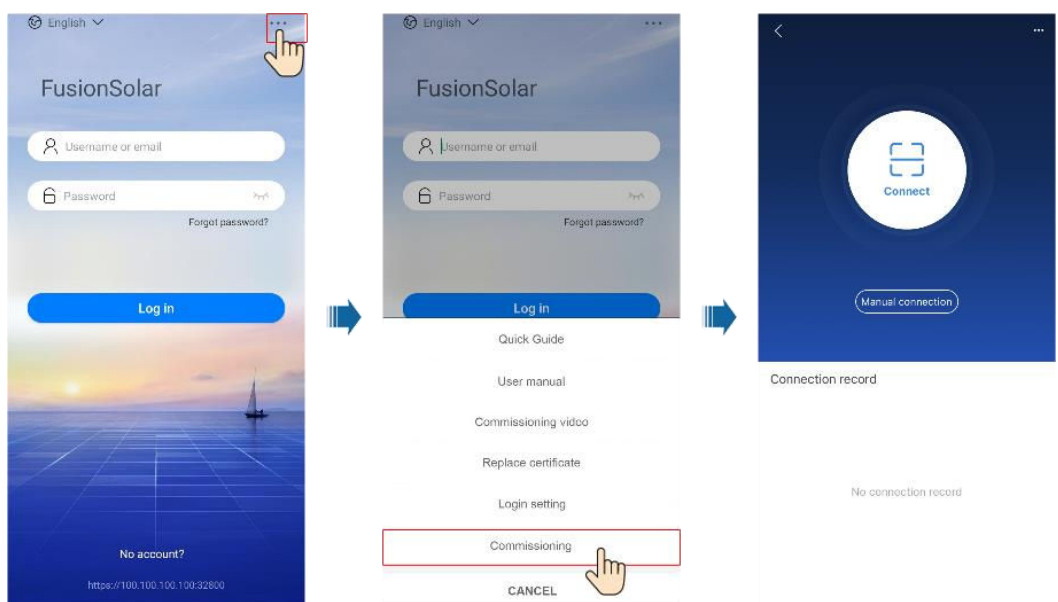

Method 3: (SUN2000 App) open SUN2000 App

 **NOTE**

Method 2 is available only when no network is available. You are advised to use method 1 to log in to the FusionSolar app to commission devices.

4 Operations on the Screen for Connecting to the Distributed Solar Inverter

4.1 Distributed Solar Inverter

Connection Modes

After the DC or AC side of the solar inverter is powered on, the app can connect to the solar inverter through the built-in WLAN of the solar inverter.

 **NOTE**

If the **This WLAN network has no Internet access. Connect anyway?** message is displayed when you connect to the built-in WLAN, tap **CONNECT**. Otherwise, you cannot log in to the system. The actual UI and messages may vary with mobile phones.

Table 4-1 Product mapping

Product	Solar Inverter Model
SUN2000L	SUN2000L-5KTL, SUN2000L-4.6KTL, SUN2000L-4KTL, SUN2000L-3.68KTL, SUN2000L-3KTL, SUN2000L-2KTL, SUN2000L-5KTL-CN, SUN2000L-5KTL-CN-4G, SUN2000L-4KTL-CN, SUN2000L-4KTL-CN-4G, SUN2000L-3KTL-CN, SUN2000L-3KTL-CN-4G
	SUN2000-7.6KTL-USL0, SUN2000-5KTL-USL0, SUN2000-3.8KTL-USL0, SUN2000-11.4KTL-USL0, SUN2000-9KTL-USL0, SUN2000L-4.95KTL-JP, SUN2000L-4.125KTL-JP, SUN2000-10KTL-USL0, SUN2000-3KTL-CNLO, SUN2000-4KTL-CNLO, SUN2000-5KTL-CNLO, SUN2000-6KTL-CNLO, SUN2000-2KTL-L0, SUN2000-3KTL-L0, SUN2000-4KTL-L0, SUN2000-5KTL-L0, SUN2000-4.95KTL-JPL0,
	SUN2000-6KTL-L1, SUN2000-5KTL-L1, SUN2000-4.6KTL-L1, SUN2000-4KTL-L1, SUN2000-3.68KTL-L1, SUN2000-3KTL-L1, SUN2000-2KTL-L1, SUN2000-4.95KTL-L1
SUN2000MA	SUN2000-5KTL-M0, SUN2000-6KTL-M0, SUN2000-8KTL-M0, SUN2000-10KTL-M0, SUN2000-12KTL-M0, SUN2000-3KTL-M0, SUN2000-4KTL-M0, SUN2000-15KTL-M0, SUN2000-17KTL-M0, SUN2000-20KTL-M0, SUN2000-8KTL-M0, SUN2000-10KTL-M0, SUN2000-12KTL-M0,

Product	Solar Inverter Model
	SUN2000-15KTL-M0, SUN2000-17KTL-M0, SUN2000-20KTL-M0
	SUN2000-3KTL-M1, SUN2000-4KTL-M1, SUN2000-5KTL-M1, SUN2000-6KTL-M1, SUN2000-8KTL-M1, SUN2000-10KTL-M1
	SUN2000-8KTL-M2, SUN2000-10KTL-M2, SUN2000-12KTL-M2, SUN2000-15KTL-M2, SUN2000-17KTL-M2, SUN2000-20KTL-M2

NOTE

The version mapping in the preceding table is subject to change and is for reference only.

4.2 Login

Procedure

Step 1 Connect the solar inverter.

Figure 4-1 Connect

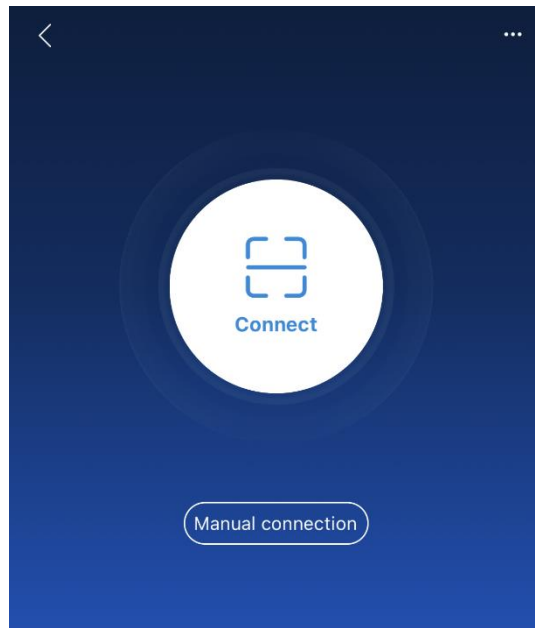

Connection record

- Code scanning: Tap **Connect** to access the scanning screen, place the QR code or bar code of the solar inverter in the scan frame. The device will be automatically connected after the code is identified.
- Manual connection: Tap **Manual Connection** and select a connection mode.

Figure 4-2 Manual connection



- Select **WLAN** and connect to the corresponding WLAN in the WLAN connection list of the APP. The initial name of the WLAN hotspot is **solar inverter SN**, and the initial password is **Changeme**.

NOTICE

- Use the initial password upon first power-on and change it immediately after login. To ensure account security, change the password periodically and keep the new password in mind. Not changing the initial password may cause password disclosure. A password left unchanged for a long period of time may be stolen or cracked. If a password is lost, devices cannot be accessed. In these cases, the user is liable for any loss caused to the PV plant.
- If the **This WLAN network has no Internet access. Connect anyway?** message is displayed when you connect to the built-in WLAN, tap **CONNECT**. Otherwise, you cannot log in to the system. The actual UI and messages may vary with mobile phones.

Step 2 Select a login user and enter the password.

Figure 4-3 Login

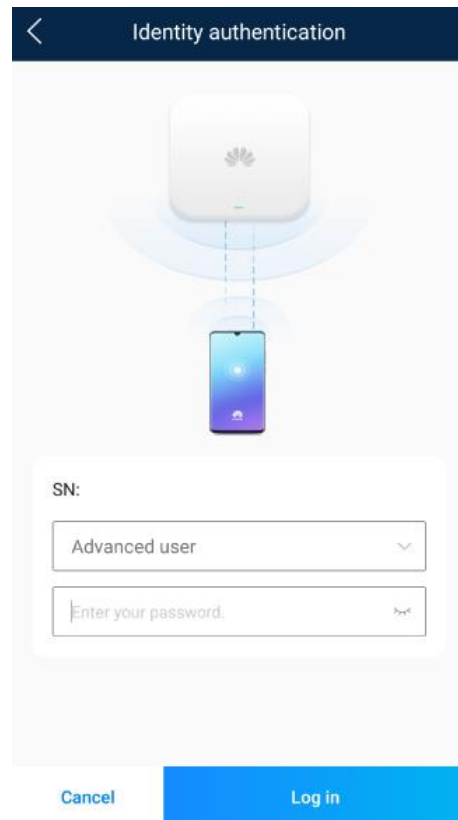

NOTICE

- The login password is the same as that for the solar inverter connected to the app and is used only when the solar inverter connects to the app.
- The initial passwords for **Common User**, **Advanced User**, and **Special User** are all **00000a**.
- Use the initial password upon first power-on and change it immediately after login. To ensure account security, change the password periodically and keep the new password in mind. Not changing the initial password may cause password disclosure. A password left unchanged for a long period of time may be stolen or cracked. If a password is lost, devices cannot be accessed. In these cases, the user is liable for any loss caused to the PV plant.
- During the login, if five consecutive invalid password entries are made (the interval between two consecutive entries is less than 2 minutes), the account will be locked for 10 minutes. The password should consist of six characters.

Step 3 After successful login, the **Quick Settings** or **Function Menu** screen is displayed.

NOTICE

- If you log in to the SUN2000 app after the device powers on for the first time or factory defaults are restored, the **Quick Settings** screen will be displayed. If you do not set the basic parameters for the solar inverter on the **Quick Settings** screen, the screen is still displayed when you log in next time.
- To set the basic parameters on the **Quick Settings** screen, switch to **Advanced User**. When you log in as **Common User** or **Special User**, enter the password of **Advanced User** in the dialog box that is displayed. After you confirm the password, go to the **Quick Settings** screen.

----End

4.3 Alarm Management

On the home screen, tap **Alarm management**. You can query active and historical alarms.

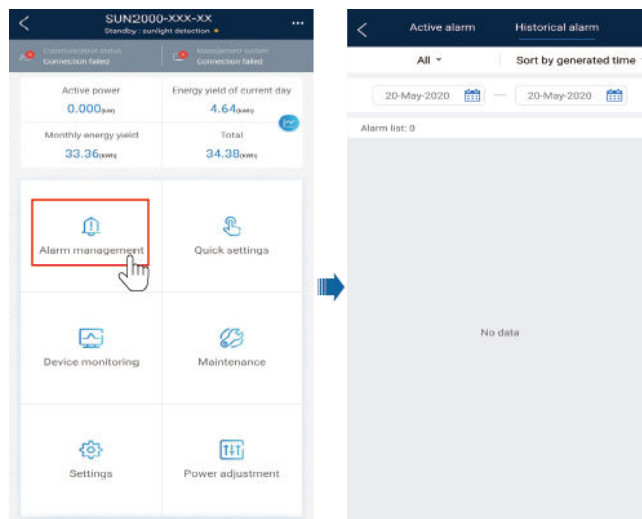

4.4 Quick Settings

On the home screen, tap **Quick Settings**. Set parameters as prompted.

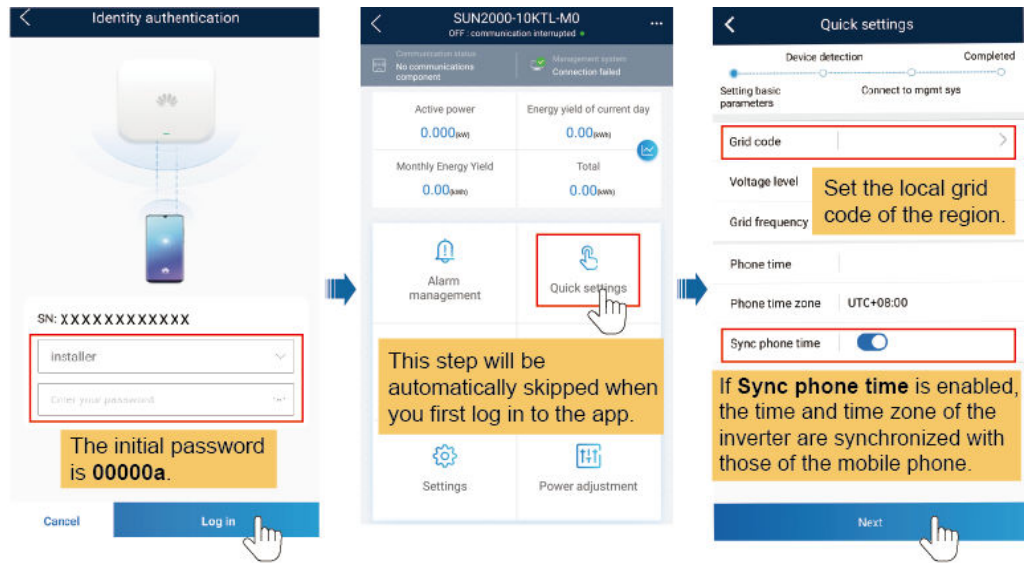

NOTE

The UI is for reference only. The UI varies with associated devices. The actual UI prevails.

4.5 Device Monitoring

On the home screen, tap **Device Monitoring**. Then tap a tab in the lower part of the screen as required to view related information.

Figure 4-4 Device information

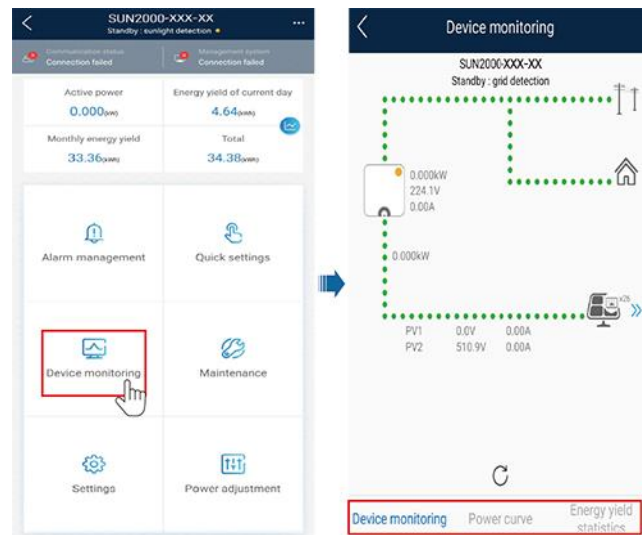

4.6 Maintenance

On the home screen, tap **Maintenance** to set device parameters.

Figure 4-5 Maintaining devices

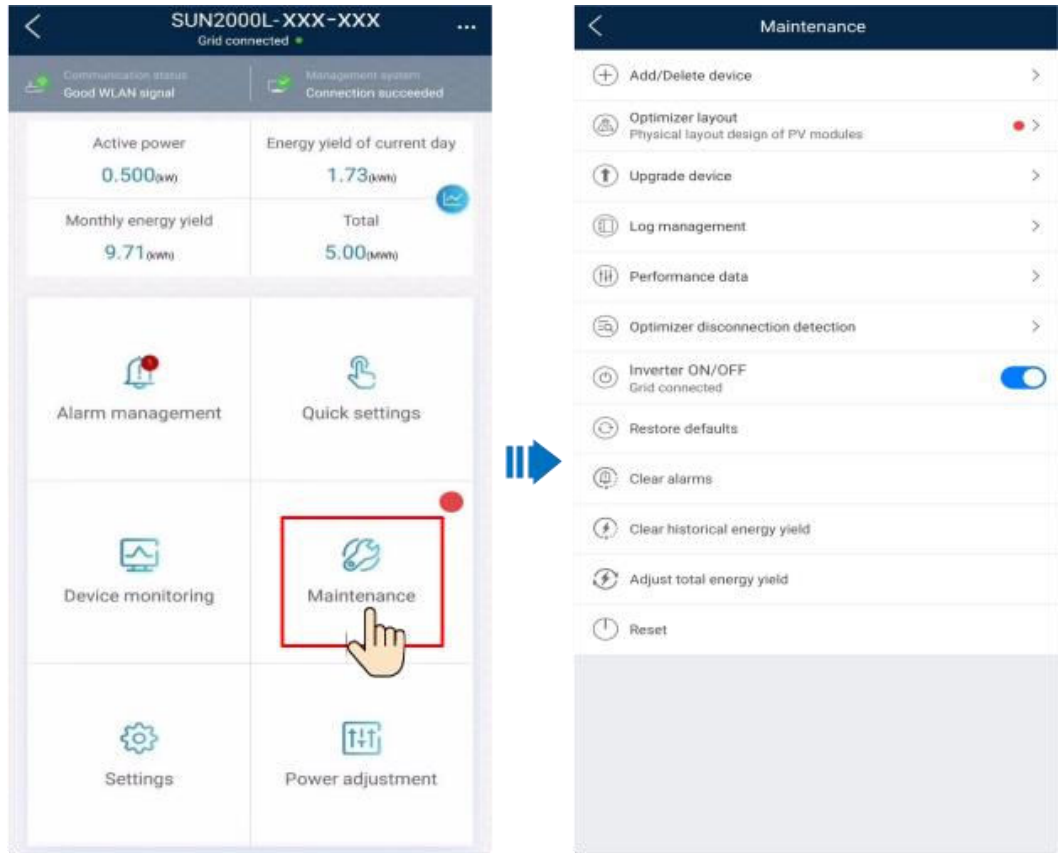

NOTE

The parameter list provided in this document includes all configurable parameters that vary with the device model and grid code. The actual screen prevails.

Parameter	Description	Parameter	Description
Add/Delete device	Adds power meters, batteries, optimizers, or safety shutdown boxes as required.	IPS test	Performs IPS self-check and generates a self-check report.
Physical Layout of PV Modules	Specifies the physical location of the optimizer.	Inverter ON/OFF Detection	Sends a command to start or shut down the solar inverter based on its current startup or shutdown status.
Upgrade device	Upgrades the software version of devices such as the solar inverter as required.	Restore defaults	Restores the solar inverter parameters to factory settings.
Log Management	Downloads the logs of the solar inverters, batteries, optimizers, or the app.	Clear alarms	Clears historical alarms of the solar inverter.
Performance data	Views the performance data of devices such as power meters.	Clear historical	Clears historical energy yields of the solar inverter.

Parameter	Description	Parameter	Description
		energy yield	
Alarm beacon	If this parameter is enabled, the alarm beacon produces audible and visual signals when the solar inverter generates an alarm.	Adjust total energy yield	Specifies the initial energy yield of the solar inverter. This parameter is used in solar inverter replacement scenarios. Set the initial energy yield of the new solar inverter to the total energy yield of the old solar inverter to ensure continuous statistics of cumulative energy yield.
AFCI self-test	Performs the AFCI self-test.	Restart	Restarts the solar inverter.
Optimizer Disconnection Detection	Detect the disconnection point of the optimizer and determine the physical location of the fault point.	--	--

4.7 Settings

On the home screen, tap **Settings** to set solar inverter parameters.

Figure 4-6 Settings

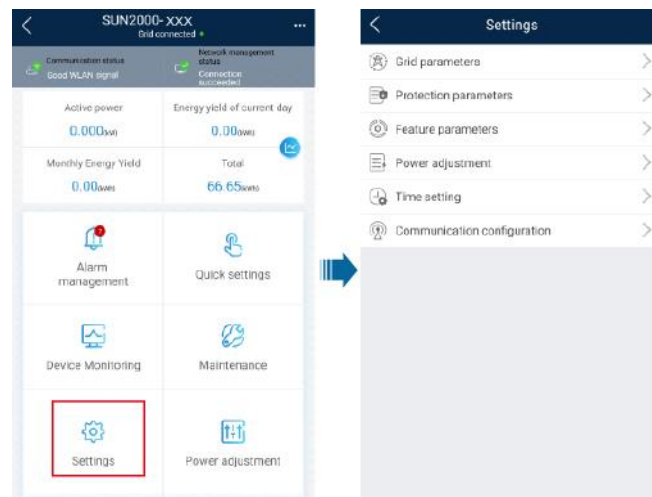

NOTE

- The parameter list provided in this document includes all configurable parameters that vary with the device model and grid code. The actual screen prevails.
- The parameters are for reference only. The configurable parameters vary with the device model and grid code. The actual configurable parameters prevail.

- The parameter names, value ranges, and default values are subject to change.

Grid Parameters

Parameter	Description	Value Range (Vn: Rated Voltage; Fn: Rated Frequency)
Grid Code	Set this parameter based on the grid code of the country or region where the inverter is used and the inverter application scenario.	N/A
Isolation settings	Set the working mode of the inverter based on the grounding status at DC side and the connection to the power grid.	<ul style="list-style-type: none"> • Input ungrounded, without TF • Input ungrounded, with TF
Output mode	Specifies whether the inverter output has a neutral wire based on the application scenario.	<ul style="list-style-type: none"> • Three-phase three-wire • Three-phase four-wire • L/N • L1/L2/N • L1/L2
Automatically start upon grid recovery	Specifies whether to allow the inverter to automatically start after the power grid recovers.	<ul style="list-style-type: none"> • Disable • Enable
Grid connected recovery time from grid faults (s)	Specifies the time after which the inverter begins connecting after the power grid recovers.	[0, 7200]
Grid reconnection voltage upper limit (V)	The standards of certain countries and regions require that after the inverter shuts down for protection due to a fault, if the power grid voltage is higher than Grid reconnection voltage upper limit , the inverter is not allowed to reconnect to the grid.	[100% Vn, 136% Vn]
Grid reconnection voltage lower limit (V)	The standards of certain countries and regions require that after the inverter shuts down for protection due to a fault, if the power grid voltage is lower than Grid reconnection voltage lower limit , the inverter is not allowed to reconnect to the grid.	[45% Vn, 100% Vn]
Grid reconnection frequency upper limit (Hz)	The standards of certain countries and regions require that after the inverter shuts down for protection due to a fault, if the power grid frequency is higher than Grid reconnection frequency upper	[100% Fn, 120% Fn]

Parameter	Description	Value Range (Vn: Rated Voltage; Fn: Rated Frequency)
	limit , the inverter is not allowed to reconnect to the grid.	
Grid reconnection frequency lower limit (Hz)	The standards of certain countries and regions require that after the inverter shuts down for protection due to a fault, if the power grid frequency is lower than Grid reconnection frequency lower limit , the inverter is not allowed to reconnect to the grid.	[80% Fn, 100% Fn]
Reactive power compensation (cosφ-P) trigger voltage (%)	Specifies the voltage threshold for triggering reactive power compensation based on the cosφ-P curve.	[100, 136]
Reactive power compensation (cosφ-P) exit voltage (%)	Specifies the voltage threshold for exiting reactive power compensation based on the cosφ-P curve.	[70, 100]

Protection Parameters

Parameter	Description	Value Range (Vn: Rated Voltage; Fn: Rated Frequency)
Insulation resistance protection threshold (MΩ)	To ensure device safety, the inverter detects the insulation resistance of the input side with respect to ground when it starts a self-check. If the detected value is less than the preset value, the inverter does not connect to the grid.	[0.02, 1.5]
Voltage unbalance protection threshold (%)	Specifies the inverter protection threshold when the power grid voltage is unbalanced.	[0, 50]
Phase protection point (°)	The Japanese standard requires that during passive islanding detection, protection should be triggered if an abrupt voltage phase change is detected.	[0.5, 15]
Phase angle offset protection	The standards of certain countries and regions require that the inverter needs to be protected when the phase angle offset of the power grid three phases exceeds a certain value.	<ul style="list-style-type: none"> • Disable • Enable
10-min overvoltage protection threshold (V)	Specifies the 10-minute overvoltage protection threshold.	[1 * Vn, 1.5 * Vn]
10-min overvoltage protection	Specifies the 10-minute overvoltage	[50, 7200000]

Parameter	Description	Value Range (Vn: Rated Voltage; Fn: Rated Frequency)
duration (ms)	protection duration.	
Level-1 overvoltage protection threshold (V)	Specifies the level-1 overvoltage protection threshold.	[1 * Vn, 1.5 * Vn]
Level-1 overvoltage protection duration (ms)	Specifies the level-1 overvoltage protection duration.	[50, 7200000]
Level-2 overvoltage protection threshold (V)	Specifies the level-2 overvoltage protection threshold.	[1 * Vn, 1.5 * Vn]
Level-2 overvoltage protection duration (ms)	Specifies the level-2 overvoltage protection duration.	[50, 7200000]
Level-3 overvoltage protection threshold (V)	Specifies the level-3 overvoltage protection threshold.	[1 * Vn, 1.5 * Vn]
Level-3 overvoltage protection duration (ms)	Specifies the level-3 overvoltage protection duration.	[50, 7200000]
Level-4 overvoltage protection threshold (V)	Specifies the level-4 overvoltage protection threshold.	[1 * Vn, 1.5 * Vn]
Level-4 overvoltage protection duration (ms)	Specifies the level-4 overvoltage protection duration.	[50, 7200000]
Level-5 overvoltage protection threshold (V)	Specifies the level-5 overvoltage protection threshold.	[1 * Vn, 1.5 * Vn]
Level-5 overvoltage protection duration (ms)	Specifies the level-5 overvoltage protection duration.	[50, 7200000]
Level-6 overvoltage protection threshold (V)	Specifies the level-6 overvoltage protection threshold.	[1 * Vn, 1.5 * Vn]
Level-6 overvoltage protection duration (ms)	Specifies the level-6 overvoltage protection duration.	[50, 7200000]
Level-1 undervoltage protection threshold (V)	Specifies the level-1 undervoltage protection threshold.	[0.15 * Vn, 1 * Vn]
Level-1 undervoltage protection duration (ms)	Specifies the level-1 undervoltage protection duration.	[50, 7200000]
Level-2 undervoltage protection threshold (V)	Specifies the level-2 undervoltage protection threshold.	[0.15 * Vn, 1 * Vn]
Level-2 undervoltage protection duration (ms)	Specifies the level-2 undervoltage protection duration.	[50, 7200000]
Level-3 undervoltage protection threshold (V)	Specifies the level-3 undervoltage protection threshold.	[0.15 * Vn, 1 * Vn]
Level-3 undervoltage protection duration (ms)	Specifies the level-3 undervoltage protection duration.	[50, 7200000]

Parameter	Description	Value Range (Vn: Rated Voltage; Fn: Rated Frequency)
Level-4 undervoltage protection threshold (V)	Specifies the level-4 undervoltage protection threshold.	[0.15 * Vn, 1 * Vn]
Level-4 undervoltage protection duration (ms)	Specifies the level-4 undervoltage protection duration.	[50, 7200000]
Level-5 undervoltage protection threshold (V)	Specifies the level-5 undervoltage protection threshold.	[0.15 * Vn, 1 * Vn]
Level-5 undervoltage protection duration (ms)	Specifies the level-5 undervoltage protection duration.	[50, 7200000]
Level-6 undervoltage protection threshold (V)	Specifies the level-6 undervoltage protection threshold.	[0.15 * Vn, 1 * Vn]
Level-6 undervoltage protection duration (ms)	Specifies the level-6 undervoltage protection duration.	[50, 7200000]
Level-1 overfrequency protection threshold (Hz)	Specifies the level-1 overfrequency protection threshold.	[1 * Fn, 1.2 * Fn]
Level-1 overfrequency protection duration (ms)	Specifies the level-1 overfrequency protection duration.	[50, 7200000]
Level-2 overfrequency protection threshold (Hz)	Specifies the level-2 overfrequency protection threshold.	[1 * Fn, 1.2 * Fn]
Level-2 overfrequency protection duration (ms)	Specifies the level-2 overfrequency protection duration.	[50, 7200000]
Level-3 overfrequency protection threshold (Hz)	Specifies the level-3 overfrequency protection threshold.	[1 * Fn, 1.2 * Fn]
Level-3 overfrequency protection duration (ms)	Specifies the level-3 overfrequency protection duration.	[50, 7200000]
Level-4 overfrequency protection threshold (Hz)	Specifies the level-4 overfrequency protection threshold.	[1 * Fn, 1.2 * Fn]
Level-4 overfrequency protection duration (ms)	Specifies the level-4 overfrequency protection duration.	[50, 7200000]
Level-5 overfrequency protection threshold (Hz)	Specifies the level-5 overfrequency protection threshold.	[1 * Fn, 1.2 * Fn]
Level-5 overfrequency protection duration (ms)	Specifies the level-5 overfrequency protection duration.	[50, 7200000]
Level-6 overfrequency protection threshold (Hz)	Specifies the level-6 overfrequency protection threshold.	[1 * Fn, 1.2 * Fn]
Level-6 overfrequency protection duration (ms)	Specifies the level-6 overfrequency protection duration.	[50, 7200000]
Level-1 underfrequency protection	Specifies the level-1 underfrequency	[0.8 * Fn, 1 * Fn]

Parameter	Description	Value Range (Vn: Rated Voltage; Fn: Rated Frequency)
threshold (Hz)	protection threshold.	
Level-1 underfrequency protection duration (ms)	Specifies the level-1 underfrequency protection duration.	[50, 7200000]
Level-2 underfrequency protection threshold (Hz)	Specifies the level-2 underfrequency protection threshold.	[0.8 * Fn, 1 * Fn]
Level-2 underfrequency protection duration (ms)	Specifies the level-2 underfrequency protection duration.	[50, 7200000]
Level-3 underfrequency protection threshold (Hz)	Specifies the level-3 underfrequency protection threshold.	[0.8 * Fn, 1 * Fn]
Level-3 underfrequency protection duration (ms)	Specifies the level-3 underfrequency protection duration.	[50, 7200000]
Level-4 underfrequency protection threshold (Hz)	Specifies the level-4 underfrequency protection threshold.	[0.8 * Fn, 1 * Fn]
Level-4 underfrequency protection duration (ms)	Specifies the level-4 underfrequency protection duration.	[50, 7200000]
Level-5 underfrequency protection threshold (Hz)	Specifies the level-5 underfrequency protection threshold.	[0.8 * Fn, 1 * Fn]
Level-5 underfrequency protection duration (ms)	Specifies the level-5 underfrequency protection duration.	[50, 7200000]
Level-6 underfrequency protection threshold (Hz)	Specifies the level-6 underfrequency protection threshold.	[0.8 * Fn, 1 * Fn]
Level-6 underfrequency protection duration (ms)	Specifies the level-6 underfrequency protection duration.	[50, 7200000]

Feature Parameters

Parameter	Description	Value Range (Vn: Rated Voltage; Fn: Rated Frequency)	Remarks
MPPT multi-peak scanning	When the inverter is used in scenarios where PV strings are greatly shaded, set this parameter to Enable , and then the inverter will perform MPPT scanning at regular intervals to locate the maximum power.	<ul style="list-style-type: none"> • Disable • Enable 	N/A

Parameter	Description	Value Range (Vn: Rated Voltage; Fn: Rated Frequency)	Remarks
MPPT multi-peak scan interval (min)	Specifies the MPPT scanning interval.	[5, 30]	This parameter is displayed when MPPT multi-peak scan interval is set to Enable .
Automatic OFF due to communication interrupted	The standards of certain countries and regions require that the inverter must shut down after the communication is interrupted for a certain time.	<ul style="list-style-type: none"> • Disable • Enable 	If Automatic OFF due to communication interrupted is set to Enable and the inverter communication is interrupted for a specified time (set by Communication interruption duration), the inverter will automatically shut down.
Communication interruption duration (min)	Specifies the duration for determining communication interruption. Used for automatic shutdown for protection in case of communication interruption.	[1, 120]	N/A
Automatic ON due to communication resume	If this parameter is set to Enable , the inverter automatically starts after communication recovers. If this parameter is set to Disable , the inverter needs to be started manually after communication recovers.	<ul style="list-style-type: none"> • Disable • Enable 	This parameter is displayed when Automatic OFF due to communication interrupted is set to Enable .
Soft start/boot time (s)	Specifies the duration for the power to gradually increase when the inverter starts.	[1, 1800]	N/A
AFCI	The North American standard requires that the inverter should have DC arc detection function.	<ul style="list-style-type: none"> • Disable • Enable 	N/A
AFCI detection adaptation mode	This function is used to adjust the sensitivity of arc detection.	<ul style="list-style-type: none"> • High • Moderate • Low 	This parameter is displayed when AFCI is set to Enable .
OFF due to abnormal ground	This function is used to check whether the solar inverter is properly grounded before the solar inverter starts, or check whether the solar inverter ground cable is disconnected when the solar inverter is	<ul style="list-style-type: none"> • Disable • Enable 	For certain power grid types, if the output side of the solar inverter is connected to an isolation transformer, grounding detection is not required. Ensure that the solar inverter is properly grounded

Parameter	Description	Value Range (Vn: Rated Voltage; Fn: Rated Frequency)	Remarks
	running. By default, this parameter is set to Enable . If the solar inverter cannot be grounded properly, it shuts down.		and set the parameter to Disable to enable the solar inverter to run properly. If you are not sure whether the solar inverter is connected to such a type of power grid, contact your dealer or Huawei technical support for confirmation.
Delay upgrade	This parameter is mainly used in the upgrade scenarios where the PV power supply is disconnected at night due to no sunlight or unstable at dawn or dusk due to poor sunlight.	<ul style="list-style-type: none"> • Disable • Enable 	After the inverter starts to upgrade, if Delay upgrade is set to Enable , the upgrade package is loaded first. After the PV power supply recovers and the activation conditions are met, the inverter automatically activates the upgrade.
Unlock optimizer	When replacing the optimizer, you need to disable the binding relationship between the optimizer and the MBUS master solar inverter. Set this parameter to Enable , and then unlock optimizer .	<ul style="list-style-type: none"> • Disable • Enable 	N/A
Heartbeat period at application layer (min)	Specifies the timeout period for the solar inverter to connect to the management system.	[1, 65535]	N/A
TCP frame length	Specifies the maximum length of the TCP frame sent by the northbound device to the solar inverter.	[320, 1500]	N/A
TCP heartbeat interval (s)	Specifies the TCP link timeout period for the solar inverter to connect to the management system.	[0, 65535]	N/A
LVRT	LVRT is short for low voltage ride-through. When the grid voltage is abnormally low for a short time, the inverter cannot disconnect from the power grid immediately and has to work for some time.	<ul style="list-style-type: none"> • Disable • Enable 	N/A

Parameter	Description	Value Range (Vn: Rated Voltage; Fn: Rated Frequency)	Remarks
Threshold for triggering LVRT (V)	Specifies the threshold for triggering LVRT. The threshold settings should meet the local grid standard.	[50% Vn, 100% Vn]	This parameter is displayed when LVRT is set to Enable .
LVRT reactive power compensation factor	During LVRT, the inverter needs to generate reactive power to support the power grid. This parameter is used to set the reactive power generated by the inverter.	[0, 10]	<ul style="list-style-type: none"> This parameter is displayed when LVRT is set to Enable. For example, if this parameter is set to 2, the reactive power generated by the inverter is 20% of the rated power when the AC voltage drops by 10% during LVRT.
LVRT characteristic curve	Specifies the low voltage ride through curve.	N/A	This parameter is displayed when LVRT is set to Enable .
HVRT	HVRT is short for high voltage ride-through. When the grid voltage is abnormally high for a short time, the inverter cannot disconnect from the power grid immediately and has to work for some time.	<ul style="list-style-type: none"> Disable Enable 	N/A
Threshold for triggering HVRT (V)	Specifies the threshold for triggering HVRT. The threshold settings should meet the local grid standard.	[100% Vn, 136% Vn]	This parameter is displayed when HVRT is set to Enable .
Grid voltage protection shield during VRT	Specifies whether to apply voltage protective shielding to the power grid when HVRT or LVRT is enabled.	<ul style="list-style-type: none"> Disable Enable 	This parameter is displayed when LVRT is set to Enable or HVRT is set to Enable .
Active islanding protection	Specifies whether to enable the active islanding protection function.	<ul style="list-style-type: none"> Disable Enable 	N/A
Passive islanding protection	Specifies whether to enable the passive islanding protection function.	<ul style="list-style-type: none"> Disable Enable 	This parameter is displayed if the Japanese grid code is selected.
Voltage rise suppression	The standards of certain countries and regions require that when the output voltage exceeds a certain value, the inverter must suppress voltage	<ul style="list-style-type: none"> Disable Enable 	N/A

Parameter	Description	Value Range (Vn: Rated Voltage; Fn: Rated Frequency)	Remarks
	rise by outputting reactive power and reducing active power.		
Voltage rise suppressing reactive power adjustment point (%)	The standards of certain countries and regions require that the inverter generate a certain amount of reactive power when the output voltage exceeds a certain value.	[100, 115)	<ul style="list-style-type: none"> This parameter is displayed when Voltage rise suppression is set to Enable. The value of Voltage rise suppressing active power derating point must be greater than that of Voltage rise suppressing reactive power adjustment point.
Voltage rise suppressing active power derating point (%)	The standards of certain countries and regions require that the active power of the inverter be derated according to a certain slope when the output voltage exceeds a certain value.	(100, 115]	
Voltage rise suppression P-U curve	The standards of certain countries and regions require that the P-U curve be set.	<ul style="list-style-type: none"> U (V): [176, 1500] U device verification (V) :[0.8 Un, 1.36 Un] P/Pn (%): [0, 100] 	This parameter is displayed when Voltage rise suppression is set to Enable .
Voltage rise suppression Q-U curve	The standards of certain countries and regions require that the Q-U curve be set.	<ul style="list-style-type: none"> U (V): [176, 1500] U device verification (V) :[0.8 Un, 1.36 Un] Q/S: [-0.6, 0.6] 	
Soft start time after grid failure (s)	Specifies the time for the power to gradually increase when the inverter restarts after the power grid recovers.	[1, 1800]	N/A
PID running mode	Specifies the operation mode of the inverter built-in PID.	<ul style="list-style-type: none"> Disable Suppress Repair Suppress + Repair 	N/A
PID nighttime off-	Specifies whether to enable the PID nighttime off-grid	<ul style="list-style-type: none"> Disable 	This parameter is displayed when PID running mode is

Parameter	Description	Value Range (Vn: Rated Voltage; Fn: Rated Frequency)	Remarks
grid repair	repair.	<ul style="list-style-type: none"> • Enable 	set to Repair .
Closed-loop controller	<ul style="list-style-type: none"> • Set this parameter to SDongle/SmartLogger when the SmartLogger1000A is connected. • If multiple inverters are cascaded, set this parameter to SDongle/SmartLogger. • If there is only one inverter, set this parameter to Inverter. 	<ul style="list-style-type: none"> • SDongle/Smart Logger • Solar inverter 	N/A
Active power output limit for fail-safe (%)	When the communication between the SDongle/SmartLogger, power meter, and solar inverter is interrupted, the solar inverter output is limited.	[0, 100]	N/A

Power Adjustment

Parameter	Description	Value Range (Vn: Rated Voltage; Fn: Rated Frequency)	Remarks
Remote power schedule	If this parameter is set to Enable , the inverter responds to the scheduling instruction from the remote port. If this parameter is set to Disable , the inverter does not respond to the scheduling instruction from the remote port.	<ul style="list-style-type: none"> • Disable • Enable 	N/A
Schedule instruction valid duration (s)	Specifies the time for maintaining the scheduling instruction.	[0, 86400]	When this parameter is set to 0, the scheduling instruction takes effect permanently.
Apparent power baseline (kVA)	Adjust the apparent output baseline of the inverter.	$[P_{max}, S_{max_real}]$	N/A
Active power	Adjusts the active output	$[0.1, \text{Min}(P_{max_real},$	N/A

Parameter	Description	Value Range (Vn: Rated Voltage; Fn: Rated Frequency)	Remarks
baseline (kW)	baseline of the inverter.	S_{max}]	
Maximum apparent power (kVA)	Specifies the output upper threshold for the maximum apparent power to adapt to the capacity requirements of standard and customized inverters.	$[P_{max}, S_{max}]$	N/A
Maximum active power (kW)	Specifies the output upper threshold for the maximum active power to adapt to different market requirements.	$[0.1, P_{max}]$	N/A
OFF at %0 power limit	If this parameter is set to Enable , the inverter shuts down after receiving the 0% power limit command. If this parameter is set to Disable , the inverter does not shut down after receiving the 0% power limit command.	<ul style="list-style-type: none"> • Disable • Enable 	N/A
Active power change gradient (%/s)	Specifies the change speed of the inverter active power.	$[0.1, 1000]$	N/A
Derated by fixed active power (kW)	Adjusts the active power output of the inverter by fixed value.	$[0, P_{max}]$	N/A
Active power percentage derating (%)	Adjusts the active power output of the inverter by percentage.	$[0, 100]$	If this parameter is set to 100 , the solar inverter generates power based on the maximum output power.
Reactive power change gradient (%/s)	Specifies the change speed of the inverter reactive power.	$[0.1, 1000]$	N/A
Reactive power compensation (Q/S)	Specifies the reactive power output by the inverter.	$[-1, 1]$	N/A
Power factor	Specifies the power factor of the inverter.	$[-1.000, -0.800] \cup [0.800, 1.000]$	N/A
Overfrequency derating	If this parameter is set to Enable , the active power of the inverter will be derated according to a certain slope when the grid frequency	<ul style="list-style-type: none"> • Disable • Enable 	N/A

Parameter	Description	Value Range (Vn: Rated Voltage; Fn: Rated Frequency)	Remarks
	exceeds the frequency that triggers overfrequency derating.		
Frequency for triggering overfrequency derating (Hz)	The standards of certain countries and regions require that the output active power of inverters be derated when the power grid frequency exceeds a certain value.	<ul style="list-style-type: none"> • 50Hz: [40, 60] • 60Hz: [48, 72] 	<ul style="list-style-type: none"> • This parameter is displayed when Overfrequency derating is set to Enable. • When setting this parameter, ensure that the following condition is met: Frequency for exiting overfrequency derating ≤ Trigger frequency of overfrequency derating < Cutoff frequency of overfrequency derating.
Frequency for exiting overfrequency derating (Hz)	Specifies the frequency threshold for exiting overfrequency derating.	<ul style="list-style-type: none"> • 50Hz: [40, 60] • 60Hz: [48, 72] 	
Cutoff frequency of overfrequency derating (Hz)	Specifies the frequency threshold for cutting off overfrequency derating.	<ul style="list-style-type: none"> • 50Hz: [40, 60] • 60Hz: [48, 72] 	
Cutoff power of overfrequency derating (%)	Specifies the power threshold for cutting off overfrequency derating.	[0, 100]	
Power recovery gradient of overfrequency derating (%/min)	Specifies the recovery rate of the overfrequency derating power.	[1, 6000]	
Dry contact scheduling	The standards of some countries and regions require that this parameter be set to Enable when power scheduling through dry contacts is required.	<ul style="list-style-type: none"> • Disable • Enable 	N/A
Dry contact scheduling settings	Specifies the dry contact power scheduling parameters.	N/A	This parameter is displayed when Dry contact scheduling is set to Enable .
cosφ-P/Pn characteristic curve	After this parameter is set, the solar inverter can adjust the power factor cosφ in real time based on the P/Pn.	<ul style="list-style-type: none"> • P/Pn (%): [0, 100] • cosφ: (-1, -0.8]U[0.8, 1] 	N/A
Q-U characteristic curve	Specifies the voltage reactive power scheduling curve.	<ul style="list-style-type: none"> • U/Un (%): [80, 136] • Q/S: [-0.6, 0.6] 	N/A
Q-U hysteresis curve	Specifies the voltage reactive power scheduling hysteresis	<ul style="list-style-type: none"> • U/Un (%): [80, 136] 	Associated with the Italian standard code.

Parameter	Description	Value Range (Vn: Rated Voltage; Fn: Rated Frequency)	Remarks
	curve.	<ul style="list-style-type: none"> Q/S: [-0.6, 0.6] 	
Underfrequency rise power	The standards of certain countries and regions require that if the power grid frequency is lower than Frequency for triggering of underfrequency rise power , the inverter needs to increase the active power output to help increase the power grid frequency. In this case, set this parameter to Enable .	<ul style="list-style-type: none"> Disable Enable 	N/A
Frequency for triggering of underfrequency rise power (Hz)	Specifies the frequency threshold of Underfrequency rise power .	<ul style="list-style-type: none"> 50Hz: [40, 60] 60Hz: [48, 72] 	<ul style="list-style-type: none"> This parameter is displayed when Underfrequency rise power is set to Enable. When setting this parameter, ensure that the following condition is met: Cutoff frequency of underfrequency rise power < Frequency for triggering of underfrequency rise power < Frequency for exiting of underfrequency rise power.
Power recovery gradient of underfrequency rise (%/min)	Specifies the recovery rate of Underfrequency rise power .	[1, 6000]	
Cutoff frequency of underfrequency rise power (Hz)	Specifies the cutoff frequency of Underfrequency rise power .	<ul style="list-style-type: none"> 50Hz: [40, 60] 60Hz: [48, 72] 	
Cutoff power of underfrequency rise power (%)	Specifies the cutoff power of Underfrequency rise power .	[0, 100]	
Frequency for exiting of underfrequency rise power (Hz)	Specifies the exit frequency of Underfrequency rise power .	<ul style="list-style-type: none"> 50Hz: [40, 60] 60Hz: [48, 72] 	

Time Setting

Parameter	Description	Value Range (Vn: Rated Voltage; Fn: Rated Frequency)	Remarks
Time zone	Specifies the time zone.	N/A	N/A
Time setting	Specifies the time.	N/A	N/A

Parameter	Description	Value Range (Vn: Rated Voltage; Fn: Rated Frequency)	Remarks
Daylight saving time	Specifies whether to enable daylight saving time (DST).	<ul style="list-style-type: none"> • Disable • Enable 	N/A
Offset time	Specifies the DST offset.	[-240, 240]	This parameter is displayed when Daylight saving time is set to Enable .
Start date	Specifies the DST offset start date.	[01-01, 12-31]	
Start time	Specifies the DST offset start time.	[00:00:00, 23:59:59]	
End date	Specifies the DST offset end date.	[01-02, 12-30]	
End date	Specifies the DST offset end time.	[00:00:00, 23:59:59]	
NTP time synchronization	Specifies whether to enable NTP time synchronization.	<ul style="list-style-type: none"> • Disable • Enable 	N/A
NTP server address	Specifies the NTP server IP address or domain name.	N/A	This parameter is displayed when NTP time synchronization is set to Enable .
NTP server port	Specifies the server port.	[0, 65535]	
NTP time synchronization interval	Specifies the NTP time synchronization interval.	[1, 1440]	

Communication Configuration

Parameter	Description	Parameter	Description
Inverter WLAN settings	Changes the WLAN password for the solar inverter.	Inverter's connection to a router	When using WLAN for communication, enter the information about the connected router.
Dongle parameter settings	If the solar inverter is configured with a Dongle, view and set communication addresses to the solar inverter.	4G	When using a 4G Dongle, enter the SIM card information.
RS485 settings	Specifies the RS485 communications parameters of the solar inverter.	Management System Configuration	Enter information about the management system to which the solar inverter connects.

Table 4-2 RS485 settings

Parameter	Description	Value Range
Protocol	Set the RS485 baud rate to be consistent with the baud rate of the devices on the same bus.	<ul style="list-style-type: none"> • 4800 • 9600 • 19200
Baud rate	The solar inverter can connect to the upper-layer management unit over the Modbus RTU, SunSpec, or AVM protocol.	<ul style="list-style-type: none"> • MODBUS RTU • Sunspec • AVM
Com address	Set the communications address of the SUN2000 when it connects to the upper-level management unit, which should not conflict with the addresses of other devices on the same bus.	[1, 247]

4.8 Power Adjustment

On the home screen, tap **Power Adjustment** and set power parameters as required.

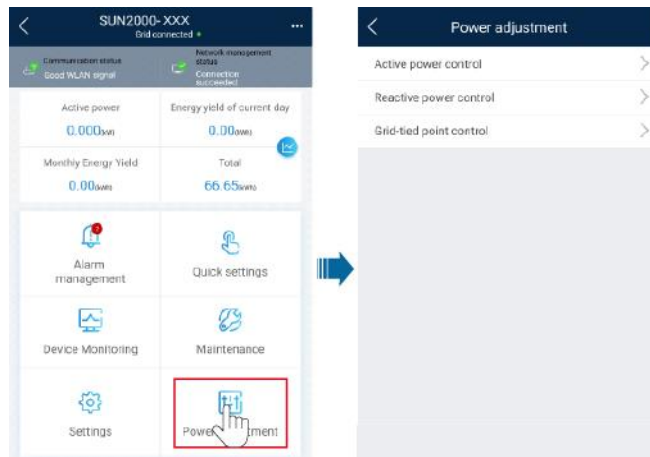

NOTE

- The UI is for reference only. The UI varies with associated devices. The actual UI prevails.
- The parameter list provided in this document includes all configurable parameters that vary with the device model and grid code. The actual screen prevails.

For details about how to set active and reactive power control parameters, see [Power Adjustment](#).

For details about how to set the grid-tied point control parameters, see [Table 4-3](#).

For details about how to set energy storage control parameters, see [Table 4-4](#).

Table 4-3 Grid-tied point control

Parameter			Description
Active power	Unlimited	N/A	If this parameter is set to Unlimited , the output power of the solar inverter is not limited and the solar inverter can connect to the power grid at the rated power.
	Grid connection with zero power	Closed-loop controller	<ul style="list-style-type: none"> When the SmartLogger1000A is connected, set this parameter to SDongle/SmartLogger. When multiple solar inverters are cascaded, set this parameter to SDongle/SmartLogger. When there is only one solar inverter, set this parameter to Inverter.
		Limitation mode	<ul style="list-style-type: none"> Total power indicates export limitation of the total power at the grid-tied point. Single-phase power indicates export limitation of the power in each phase at the grid-tied point. (Note: COUNTIS E43 does not apply to this scenario.)
		Power adjustment period	Specifies the shortest interval for a single export limitation adjustment.
		Maximum protection time	Specifies the time for detecting power meter data. If the Dongle does not detect any power meter data within the preset time, the Dongle delivers the preset value of the Fail-safe power threshold to the solar inverter for protection.
		Power control hysteresis	Specifies the dead zone for adjusting the inverter output power. If the power fluctuation is within the power control hysteresis, the power is not adjusted.
		Communication disconnection fail-safe	In the solar inverter export limitation scenario, if this parameter is set to Enable , the solar inverter will derate according to the active power derating percentage when the communication between the solar inverter and the Dongle is disconnected for a period longer than Communication disconnection detection time .
		Communication disconnection detection time	Specifies the time for determining the communication disconnection between the solar inverter and the Dongle. This parameter is displayed only when Communication disconnection fail-safe is set to Enable .
		Active power output limit for fail-safe	Specifies the derating value of the solar inverter active power by percentage. If the Dongle does not detect any power meter data or the communication between the Dongle and the solar inverter is disconnected, the Dongle delivers the derating value of the solar inverter active power by percentage.
	Grid connection with limited power	Closed-loop controller	<ul style="list-style-type: none"> For a single inverter, set Closed-loop controller to Inverter or SDongle/SmartLogger. <ul style="list-style-type: none"> When Closed-loop controller is set to Inverter, the duration of export limitation control is less than 2s. When Closed-loop controller is set to

Parameter		Description
(kW)		<p>SDongle/SmartLogger, the duration of export limitation is less than 5s.</p> <ul style="list-style-type: none"> For multiple inverters, Closed-loop controller can only be set to SDongle/SmartLogger. The duration of export limitation control is less than 5s.
	Limitation mode	<ul style="list-style-type: none"> Total power indicates export limitation of the total power at the grid-tied point. Single-phase power indicates export limitation of the power in each phase at the grid-tied point. (Note: COUNTIS E43 does not apply to this scenario.)
	PV plant capacity	Specifies the total maximum active power in the solar inverter cascading scenario.
	Maximum grid feed-in power (kW)	Specifies the maximum active power transmitted from the grid-tied point to the power grid.
	Power adjustment period	Specifies the shortest interval for a single export limitation adjustment.
	Maximum protection time	Specifies the time for detecting power meter data. If the Smart Dongle does not detect any power meter data within the preset time, the Smart Dongle delivers the preset value of the Fail-safe power threshold to the inverter for protection.
	Power control hysteresis	Specifies the dead zone for adjusting the inverter output power. If the power fluctuates within the power control hysteresis, the power is not adjusted.
	Communication disconnection fail-safe	In the inverter export limitation scenario, if this parameter is set to Enable , the inverter will derate according to the active power derating percentage when the communication between the inverter and the Smart Dongle is disconnected for a period longer than Communication disconnection detection time .
	Communication disconnection detection time	Specifies the time for determining the communication disconnection between the inverter and the Smart Dongle. This parameter is displayed when Communication disconnection fail-safe is set to Enable .
Active power output limit for fail-safe	Specifies the derating value of the inverter active power by percentage. If the Smart Dongle does not detect any power meter data or the communication between the Smart Dongle and the inverter is disconnected, the Smart Dongle delivers the derating value of the inverter active power by percentage.	
Grid connection with limited power (%)	Closed-loop controller <ul style="list-style-type: none"> For a single inverter, set Closed-loop controller to Inverter or SDongle/SmartLogger. <ul style="list-style-type: none"> When Closed-loop controller is set to Inverter, the duration of export limitation control is less than 2s. When Closed-loop controller is set to SDongle/SmartLogger, the duration of export limitation is 	

Parameter		Description	
			<p>less than 5s.</p> <ul style="list-style-type: none"> For multiple inverters, Closed-loop controller can only be set to SDongle/SmartLogger. The duration of export limitation control is less than 5s.
		Limitation mode	<ul style="list-style-type: none"> Total power indicates export limitation of the total power at the grid-tied point. Single-phase power indicates export limitation of the power in each phase at the grid-tied point. (Note: COUNTIS E43 does not apply to this scenario.)
		PV plant capacity	Specifies the total maximum active power in the inverter cascading scenario.
		Maximum grid feed-in power (%)	Specifies the percentage of the maximum active power of the grid-tied point to the PV plant capacity.
		Power adjustment period	Specifies the shortest interval for a single export limitation adjustment.
		Maximum protection time	Specifies the time for detecting power meter data. If the Smart Dongle does not detect any power meter data within the preset time, the Smart Dongle delivers the preset value of the Fail-safe power threshold to the inverter for protection.
		Power control hysteresis	Specifies the dead zone for adjusting the inverter output power. If the power fluctuates within the power control hysteresis, the power is not adjusted.
		Communication disconnection fail-safe	In the inverter export limitation scenario, if this parameter is set to Enable , the inverter will derate according to the active power derating percentage when the communication between the inverter and the Smart Dongle is disconnected for a period longer than Communication disconnection detection time .
		Communication disconnection detection time	Specifies the time for determining the communication disconnection between the inverter and the Smart Dongle. This parameter is displayed when Communication disconnection fail-safe is set to Enable .
		Active power output limit for fail-safe	Specifies the derating value of the inverter active power by percentage. If the Smart Dongle does not detect any power meter data or the communication between the Smart Dongle and the inverter is disconnected, the Smart Dongle delivers the derating value of the inverter active power by percentage.
Reactive power	Power factor closed-loop control	Target power factor	Specifies the target power factor of the power meter.
		Reactive power adjustment period	Specifies the interval for sending adjustment commands.
		Reactive power	Specifies the adjustment power factor precision.

Parameter		Description
	adjustment deadband	
	Fail-safe power factor	When the communication between the SDongle/SmartLogger, power meter, and solar inverter is interrupted, the solar inverter outputs power based on this threshold.
	Communication disconnection fail-safe	When this parameter is set to Enable , and the communication between the solar inverter and the SDongle/SmartLogger is interrupted for a certain period (set by Communication disconnection detection time), the solar inverter outputs power based on Fail-safe power .
	Communication disconnection detection time	Specifies the protection duration to determine whether the communication between the SDongle/SmartLogger and the solar inverter is interrupted. This parameter is displayed only when Communication disconnection fail-safe is set to Enable .
No Output	N/A	If this parameter is set to No Output , no parameter is available.

Table 4-4 Energy storage control

Parameter		Description
Forcible charge/discharge	Charge/discharge power	Specifies the forced charge/discharge manually.
	Forced charge/discharge power (kW)	Specifies the forced charge/discharge power.
	Forced charge/discharge period (mins)	Specifies the forced charge/discharge duration.
	Remaining charge/discharge time (mins)	Displays the remaining charge and discharge time, which cannot be set.
Control mode		<ul style="list-style-type: none"> If this parameter is set to Fixed charge/discharge, you can charge or discharge the batteries in the specified time period. A maximum of 10 time periods can be added. If this parameter is set to Maximise self consumption and the solar inverter connects to a power meter, the solar inverter provides output power for local loads before feeding the remaining power to the power grid. If this parameter is set to Time-of-use price, batteries discharge when the electricity price is high and charge when the electricity price is low. A maximum of 10 time periods can be added. <p>NOTE When setting Time-of-use price, ensure that the number of time periods is greater than or equal to 2, and that the number of tariffs is greater than or equal to 2.</p>

Parameter	Description
Charge from AC	<p>If this parameter is set to Enable, the batteries can be charged with the power supply from the power grid.</p> <p>If this parameter is set to Disable before delivery, you must comply with the local regulations on charging the batteries with the power supply from the power grid.</p>

 **NOTE**

The duration for export limitation control is as follows:

- For a single solar inverter, set **Closed-loop controller** to **Inverter** or **SDongle/SmartLogger**.
- When **Closed-loop controller** is set to **Inverter**, the duration of export limitation control is less than 2s.
- When **Closed-loop controller** is set to **SDongle/SmartLogger**, the duration is less than 5s if the controller is the SDongle. The duration is less than 2s if the controller is the SmartLogger.
- For multiple solar inverters, **Closed-loop controller** can only be set to **SDongle/SmartLogger**.
- The duration is less than 5s if the controller is the SDongle.
- The duration is less than 2s if the controller is the SmartLogger.

5 Operations on the Screen for Connecting to the Commercial Solar Inverter

5.1 Commercial Solar Inverter

Table 5-1 Product mapping

Product	Solar Inverter Model
SUN2000	SUN2000-20KTL, SUN2000-17KTL, SUN2000-15KTL, SUN2000-12KTL, SUN2000-10KTL, SUN2000-8KTL, SUN2000-24.5KTL, SUN2000-23KTL, SUN2000-28KTL, SUN2000-33KTL, SUN2000-40KTL, SUN2000-25KTL-US, SUN2000-30KTL-US, SUN2000-30KTL-A, SUN2000-22KTL-US, SUN2000-42KTL, SUN2000-36KTL, SUN2000-33KTL-JP, SUN2000-40KTL-JP, SUN2000-50KTL, SUN2000-24.7KTL-JP, SUN2000-40KTL-US, SUN2000-33KTL-US, SUN2000-36KTL-US, SUN2000-33KTL-A, SUN2000-33KTL-E001, SUN2000-29.9KTL
	SUN2000-70KTL-C1, SUN2000-75KTL-C1, SUN2000-50KTL-C1, SUN2000-43KTL-IN-C1
	SUN2000-65KTL-M0, SUN2000-70KTL-INM0, SUN2000-63KTL-JPM0, SUN2000-50KTL-JPM0, SUN2000-60KTL-M0, SUN2000-50KTL-M0, SUN2000-100KTL-M0, SUN2000-100KTL-INM0, SUN2000-110KTL-M0, SUN2000-125KTL-M0
	SUN2000-100KTL-M1, SUN2000-50KTL-JPM1
SUN2000HA	SUN2000-60KTL-HV-D1, SUN2000-45KTL-US-HV-D0, SUN2000-55KTL-HV-D1, SUN2000-55KTL-IN-HV-D1, SUN2000-55KTL-HV-D1-001, SUN2000-60KTL-HV-D1-001
	SUN2000-100KTL-USH0, SUN2000-100KTL-H0, SUN2000-95KTL-INH0, SUN2000-90KTL-H0, SUN2000-63KTL-JPH0, SUN2000-175KTL-H0, SUN2000-185KTL-INH0, SUN2000-193KTL-H0, SUN2000-196KTL-H0, SUN2000-215KTL-H0, SUN2000-125KTL-JPH0
	SUN2000-100KTL-H1, SUN2000-90KTL-H1, SUN2000-105KTL-H1, SUN2000-95KTL-INH1, SUN2000-168KTL-H1, SUN2000-185KTL-H1, SUN2000-196KTL-H1
	SUN2000-100KTL-H2, SUN2000-90KTL-H2, SUN2000-200KTL-H2

Table 5-2 Product mapping (iOS)

Solar Inverter Model	Version	App Version	Connection Mode		
			USB-Adapter2000-B Bluetooth Module	BF4030 Bluetooth Module	USB Data Cable
SUN2000-8KTL, SUN2000-10KTL, SUN2000-12KTL, SUN2000-15KTL, SUN2000-17KTL, SUN2000-20KTL, SUN2000-23KTL, SUN2000-24.5KTL, and SUN2000-28KTL	SUN2000 V100R001C81 SPC110 and later versions	2.2.00.050	Supported	Not supported	Not supported
SUN2000-30KTL-A, SUN2000-33KTL, SUN2000-33KTL-E001, and SUN2000-40KTL	SUN2000 V200R001C90 SPC109 and later versions				
SUN2000-22KTL-US, SUN2000-25KTL-US, and SUN2000-30KTL-US	SUN2000 V200R001C02 SPC102 and later versions				
SUN2000-33KTL-JP, SUN2000-40KTL-JP, SUN2000-29.9KTL, SUN2000-33KTL-A, SUN2000-36KTL,	SUN2000 V200R002C00 SPC102 and later versions				

Solar Inverter Model	Version	App Version	Connection Mode		
			USB-Adapter2000-B Bluetooth Module	BF4030 Bluetooth Module	USB Data Cable
SUN2000-42KTL, SUN2000-43KTL-IN-C1, SUN2000-50KTL, and SUN2000-50KTL-C1					
SUN2000-60KTL-HV-D1	SUN2000HA V100R001C00 and later versions				
SUN2000-45KTL-US-HV-D0	SUN2000HA V100R001C10 and later versions				
SUN2000-33KTL-US/36KTL-US/40KTL-US	SUN2000 V200R002C20 and later versions				
SUN2000-70KTL-C1, SUN2000-65KTL-C1, SUN2000-60KTL-M0, SUN2000-50KTL-M0, SUN2000-65KTL-M0, SUN2000-70KTL-INM0, SUN2000-75KTL-C1, SUN2000-63KTL-JPM0, SUN2000-50KTL-JPM0, and SUN2000-50KTL-JPM1	SUN2000 V300R001C00 and later versions				
SUN2000-125KTL-M0	SUN2000 V500R001C00 and later versions				

Solar Inverter Model	Version	App Version	Connection Mode		
			USB-Adapter2000-B Bluetooth Module	BF4030 Bluetooth Module	USB Data Cable
SUN2000-90KTL-H0, SUN2000-90KTL-H1, SUN2000-90KTL-H2, SUN2000-95KTL-INH0, SUN2000-95KTL-INH1, SUN2000-100KTL-H0, SUN2000-100KTL-H1, SUN2000-100KTL-H2, SUN2000-105KTL-H1, and SUN2000-63KTL-JPH0	SUN2000HA V200R001C30 and later versions				
SUN2000-100KTL-USH0	SUN2000HA V200R001C20 and later versions				
SUN2000-175KTL-H0, SUN2000-185KTL-INH0, and SUN2000-185KTL-H1	SUN2000HA V300R001C00 and later versions				

 **NOTE**

- The version mapping in the preceding table is subject to change and is for reference only.
- You can view the solar inverter version on the app, LCD, SmartLogger, and the management system.

5.2 Connection Modes

After the DC or AC side of a solar inverter is energized, the app can connect to the solar inverter in two methods:

1. Connect over a WLAN/Bluetooth module.

Figure 5-1 WLAN/Bluetooth connection

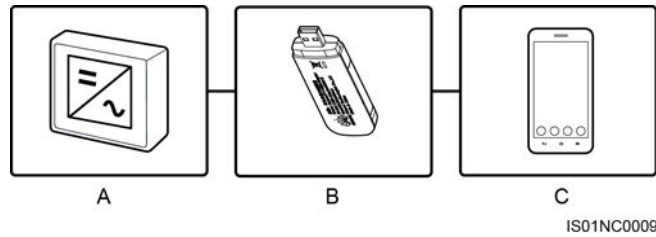

(A) Solar inverter (B) WLAN/Bluetooth module (C) Mobile phone

2. Connect over a USB data cable.

Figure 5-2 USB data cable connection

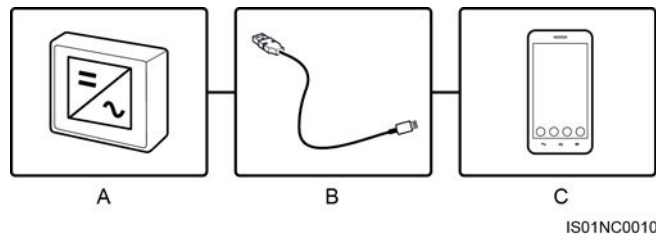

(A) Solar inverter (B) USB data cable (C) Mobile phone

5.3 Required Accessories

Mobile Phone

- Mobile phone operating system: Android 4.4 or later
- Recommended phone brands: Huawei and Samsung
- The mobile phone supports the access to the Internet over a web browser.
- WLAN/Bluetooth supported

WLAN/Bluetooth Module

Purchase a Bluetooth module or WLAN module that matches the solar inverter. A Bluetooth module or a WLAN module purchased from any other source may not support communication between the app and the solar inverter.

Table 5-3 WLAN/Bluetooth module model

Model	Module	Item Code	Purchased From
USB-Adapter2000-C	WLAN module	02312MCK	Can be purchased from Huawei

Model	Module	Item Code	Purchased From
USB-Adapter2000-B	Bluetooth module	02311NEA	
BF4030	Bluetooth module	06080358	

USB Data Cable

The USB data cable is delivered with the phone.

NOTE

The port type of the USB data cable connected to the solar inverter is USB 2.0.

5.4 User Operation Permissions

The user accounts that can log in to the app are classified into common users, special users, and advanced users. You can set different user permissions based on the responsibilities of PV plant operation personnel.

- Common user: Has the permission of viewing data and setting user parameters.
- Advanced user: Has the permission of viewing data, setting functional parameters, and maintaining devices.
- Special user: Has the permissions of viewing solar inverter data, setting grid related parameters, and maintaining devices (including starting and shutting down the solar inverter, restoring factory defaults, and upgrading devices).

Figure 5-3 Operation permissions of common users

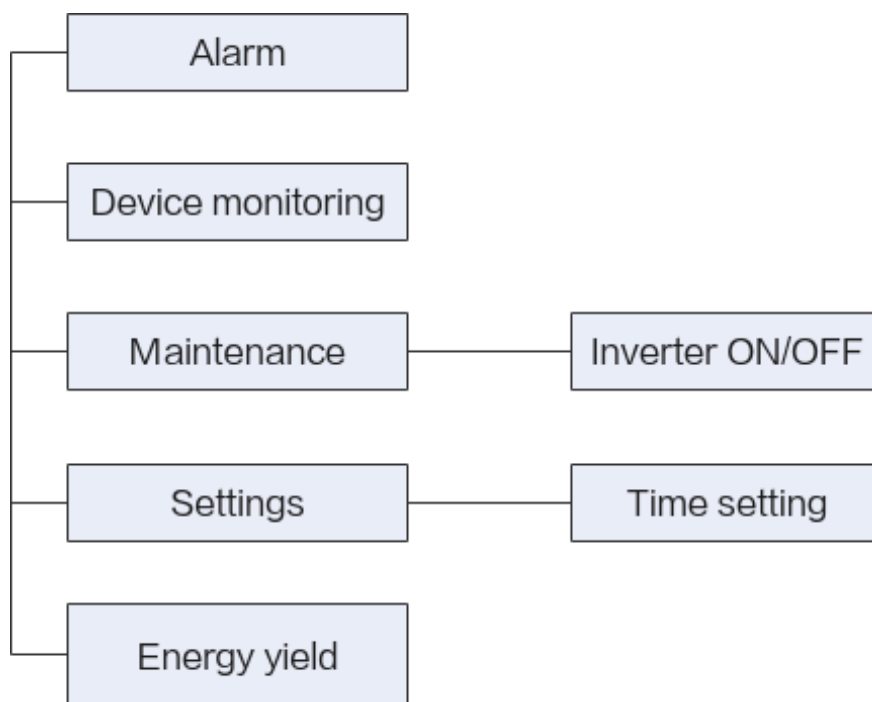
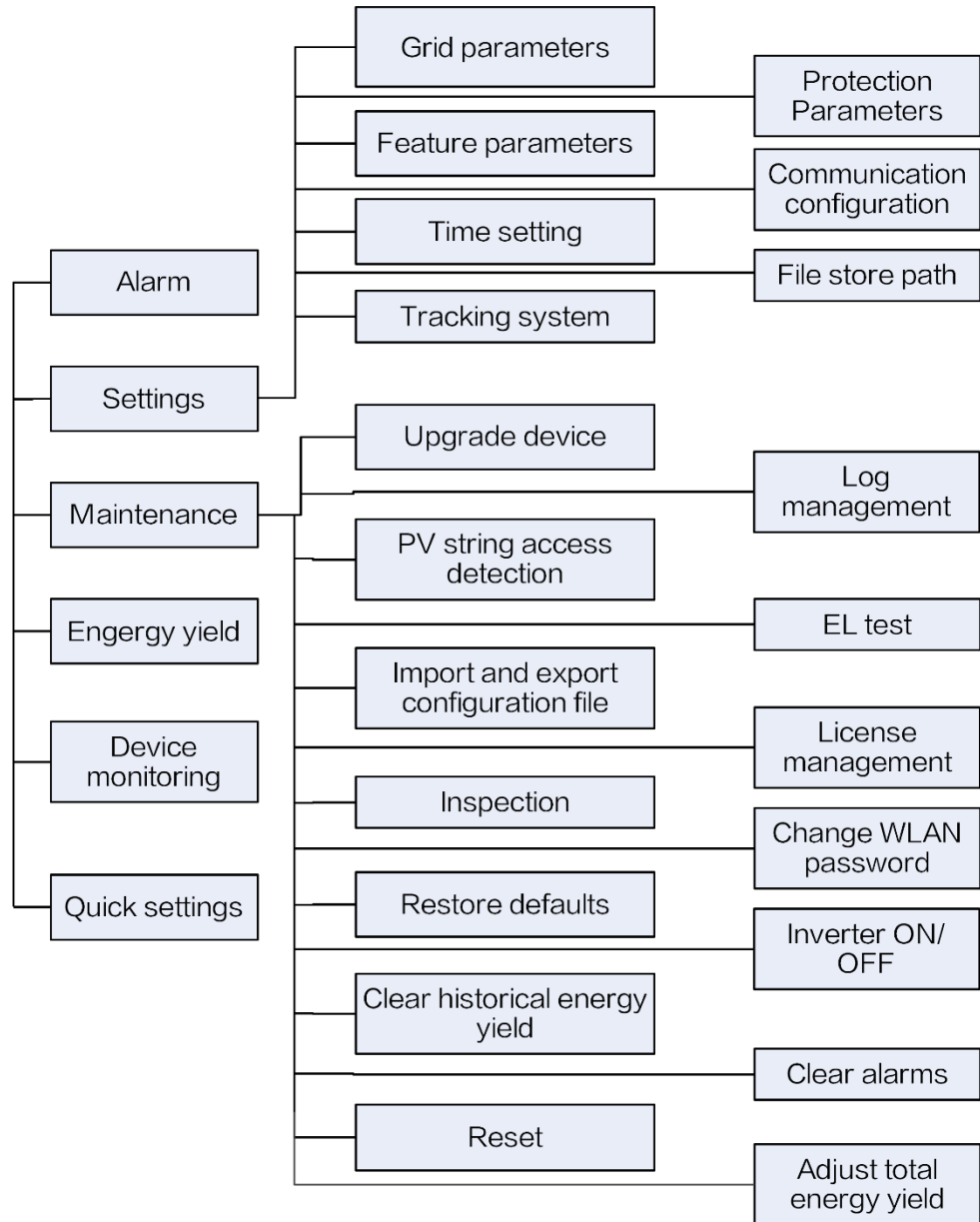

Figure 5-4 Operation permissions of advanced users



NOTE

- **Track system** is available for SUN2000 V200R001C91 and SUN2000 V200R001C93 of 1000 V solar inverters, all 1100 V solar inverters, and all 1500 V solar inverters.
- **Spot-check** is available only to solar inverters using the **Japanese grid code**.
- **Start DC input detection** is available only to 1500 V solar inverters.
- **AFCI self-test** is available only to the solar inverters whose technical specifications contain AFCI on the product nameplate.
- **File store path** is displayed only for the Android system.

Figure 5-5 Operation permissions of special users

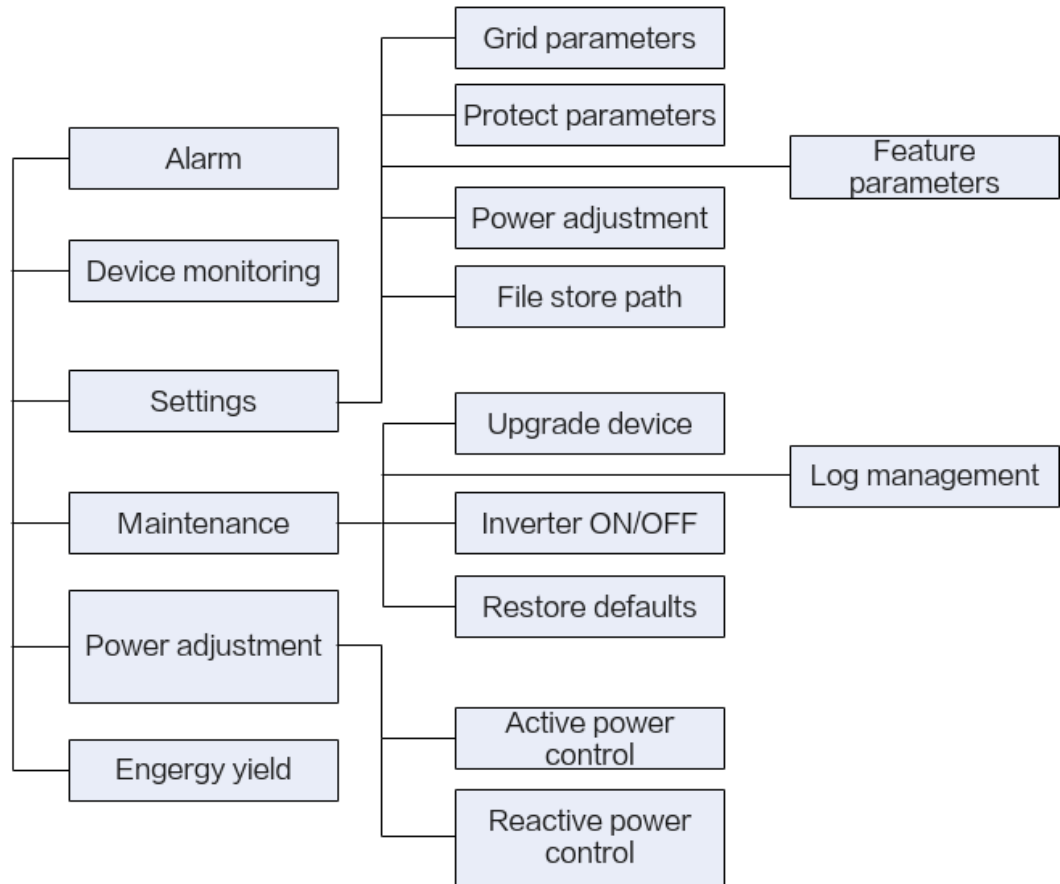

5.5 Login

Prerequisites

- The DC or AC side of the solar inverter has been energized.
- Connect over a WLAN/Bluetooth module:
 - a. The WLAN/Bluetooth module is connected to the **USB** port at the bottom of the solar inverter.
 - b. The WLAN/Bluetooth function is enabled on the mobile phone.
 - c. Keep the mobile phone within 5 m from the solar inverter. Otherwise, communication between them would be affected.
- Connect over a USB data cable:
 - a. The USB data cable is connected from the USB port at the bottom of the solar inverter to the USB port on the mobile phone.
 - b. The USB data cable has been successfully connected and **Connected to USB Accessory** is displayed on the screen. Otherwise, the connection is invalid.

Procedure

Step 1 Connect the solar inverter.

Figure 5-6 Connect

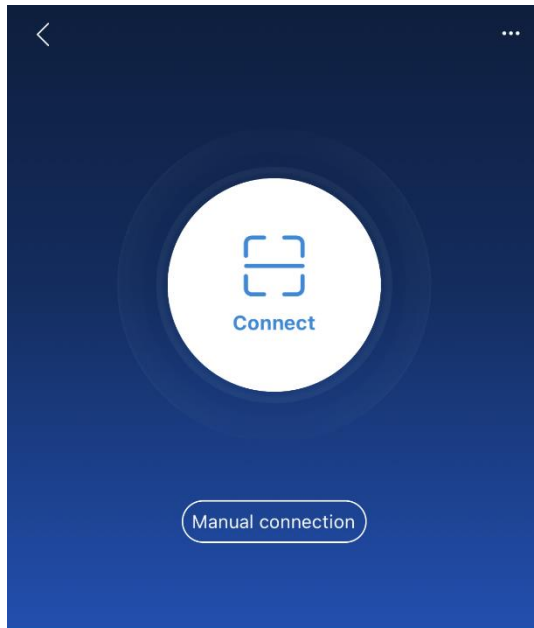

Connection record

- Code scanning: Tap **Connect** to access the scanning screen, place the QR code or bar code of the WLAN/Bluetooth module in the scan frame. The device will be automatically connected after the code is identified.
- Manual connection: Tap **Manual Connection** and select a connection mode.

Figure 5-7 Manual connection



- Select **WLAN** and connect to the corresponding WLAN in the WLAN connection list of the APP. The initial name of the WLAN hotspot is **Adapter-WLAN module SN**, and the initial password is **Changeme**.

NOTICE

- Use the initial password upon first power-on and change it immediately after login. To ensure account security, change the password periodically and keep the new password in mind. Not changing the initial password may cause password disclosure. A password left unchanged for a long period of time may be stolen or cracked. If a password is lost, devices cannot be accessed. In these cases, the user is liable for any loss caused to the PV plant.
 - If the **This WLAN network has no Internet access. Connect anyway?** message is displayed when you connect to the built-in WLAN, tap **CONNECT**. Otherwise, you cannot log in to the system. The actual UI and messages may vary with mobile phones.
-
- Select **Bluetooth**, and tap **Search for device**. After a Bluetooth device is found, select the target Bluetooth device, and set up a connection. If the Bluetooth module is USB-Adapter2000-B, the connected Bluetooth device is named after **last 8 digits of the SN barcode + HWAPP**.
 - Select **USB**, and tap **Confirm** to allow the app to access the USB accessory. After you select **Use by default for this USB accessory**, the message will not appear if you log in to the app again without removing the USB data cable.

Step 2 Select a login user and enter the password.

Figure 5-8 Login

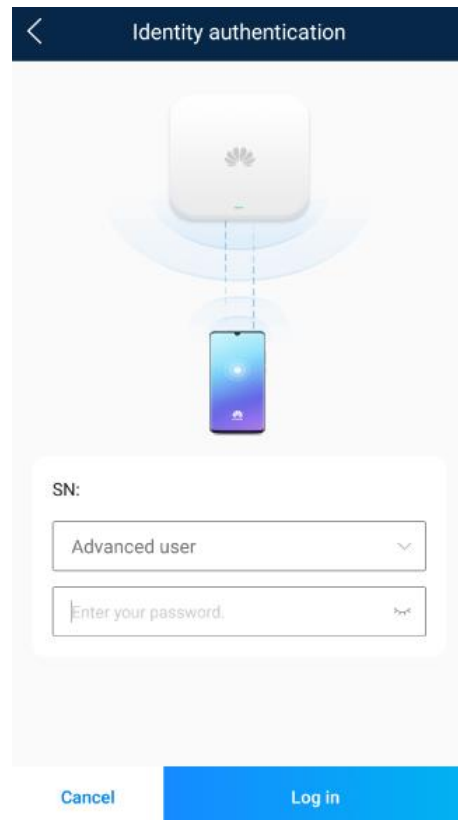

NOTICE

- The login password is the same as that for the solar inverter connected to the app and is used only when the solar inverter connects to the app.
- You have to set the login password upon the first login.
- To ensure account security, change the password periodically and keep the new password in mind. Not changing the initial password may cause password disclosure. A password left unchanged for a long period of time may be stolen or cracked. If a password is lost, devices cannot be accessed. In these cases, the user is liable for any loss caused to the PV plant.
- During the login, if five consecutive invalid password entries are made (the interval between two consecutive entries is less than 2 minutes), the account will be locked for 10 minutes. The password should consist of six characters.

Step 3 After successful login, the **Quick Settings** or **Function Menu** screen is displayed.

NOTICE

- If you log in to the SUN2000 app after the device powers on for the first time or factory defaults are restored, the **Quick Settings** screen will be displayed. If you do not set the basic parameters for the solar inverter on the **Quick Settings** screen, the screen is still displayed when you log in next time.
- To set the basic parameters on the **Quick Settings** screen, switch to **Advanced User**. When you log in as **Common User** or **Special User**, enter the password of **Advanced User** in the dialog box that is displayed. After you confirm the password, go to the **Quick Settings** screen.

Table 5-4 Quick settings

Parameter	Description
Grid code	Set this parameter based on the grid code of the country or region where the SUN2000 is used and the SUN2000 application scenario.
Date	Specifies the system date.
Time	Specifies the system time.
Baud rate (bps)	Set the RS485 baud rate to be consistent with the baud rate of the devices on the same bus.
RS485 protocol	<ul style="list-style-type: none"> • The solar inverter can connect to the upper-layer management unit over the Modbus RTU, SunSpec, or AVM protocol. • When the solar inverter connects to the support tracking system, only the Modbus RTU protocol is supported.
Com address	Set the communications address of the SUN2000 when it connects to the upper-level management unit, which should not conflict with the addresses of other devices on the same bus.

----End

5.6 Screen Operations (Common User)

5.6.1 Query

Procedure

- Step 1** After logging in to the app, you can view the active power and energy yield of solar inverters on the home screen.

Figure 5-9 Home screen

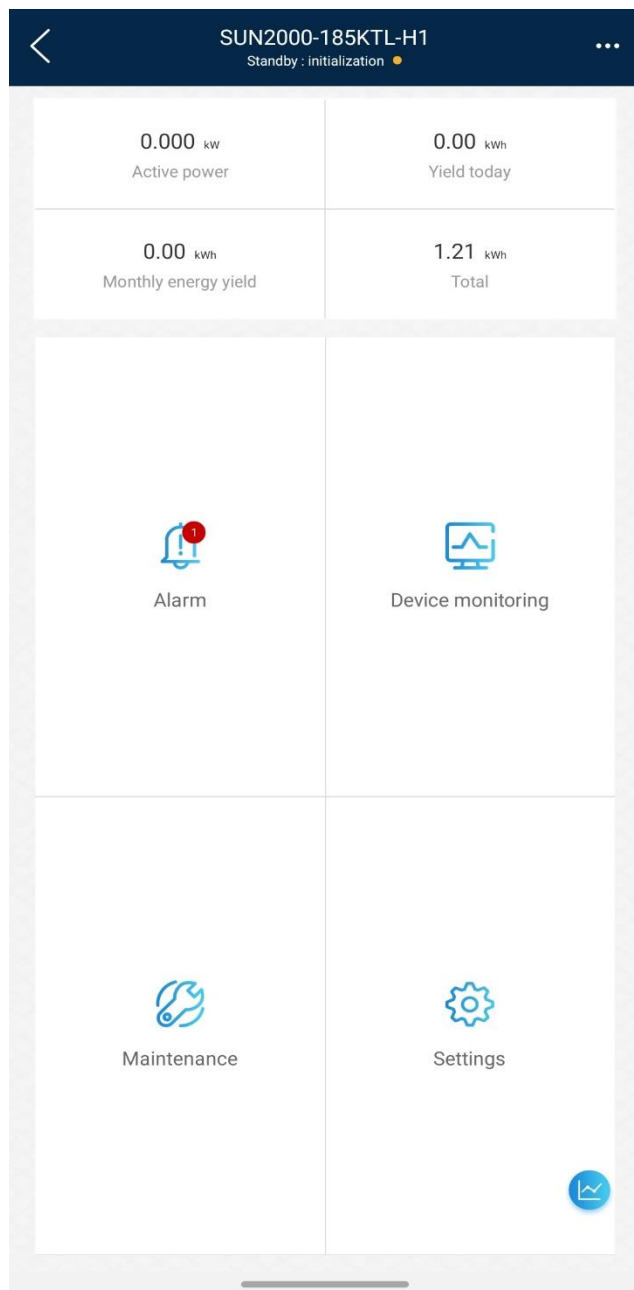

Step 2 Tap **Alarm** or **Device Monitoring** to view active alarms, historical alarms, and running information of the solar inverters.

You can view the following information on the **alarm** screen:

- Tap an alarm record and view the alarm details.
- Tap either **Active Alarm** or **Historical Alarm** to display a list of active alarms or historical alarms.

NOTE

- Tap **Sort by generated time** to set the alarm sorting mode for active alarms or historical alarms.

- Tap  to set a time criterion. The historical alarms generated within the time segment are displayed.
- Select the alarms that can be manually cleared, and tap **Delete** on the right of the alarm to manually clear the alarms.

 **NOTE**

- Alarms that have been manually cleared can be viewed on the **Historical Alarm** screen.
- Only the **AFCI Self-Check Failure** and **DC Arc Fault** alarms can be manually cleared. Only the products whose technical specifications contain AFCI supports manual alarm clearance.

----End

5.6.2 Settings

Context

Due to permission restrictions, common users can set time parameters only for the solar inverters.

Procedure

- Step 1** On the home screen, choose **Settings** > **Time setting** and set the system time.

Figure 5-10 Time settings (common user)

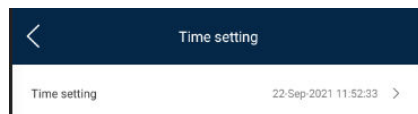

 **NOTE**

- For a solar inverter that supports DST, if an advanced user enables DST, a common user can view DST data.
- When an advanced user enables NTP time synchronization, common users can view the related data.

----End

5.6.3 Maintenance

5.6.3.1 System Maintenance

Context

Because of permission restriction, common users can only turn on or off solar inverters.

Procedure

- Step 1** On the home screen, tap **Maintenance** to access the maintenance screen.

Figure 5-11 Maintenance

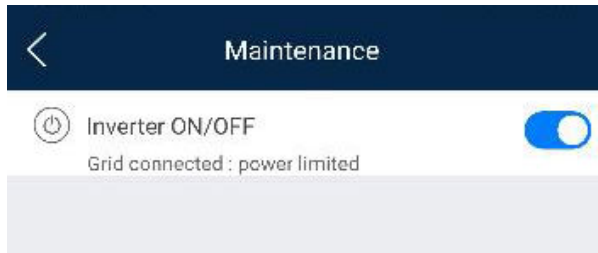

Step 2 Tap  next to **Inverter ON/OFF** to perform the operation.

Step 3 Enter the password for logging in to the app, and tap **Confirm**.

----End

5.6.3.2 Feedback

Context

Users can provide feedback in text, pictures, and files.

NOTE

Do not add private data.

Procedure

Step 1 Choose  > **Feedback** in the upper-right corner of the home screen.

Figure 5-12 Feedback



Step 2 Tap **Specify the type** and select **Feedback** or **Suggestion**.

Step 3 Briefly describe the problem that you encounter in the **Description** column.

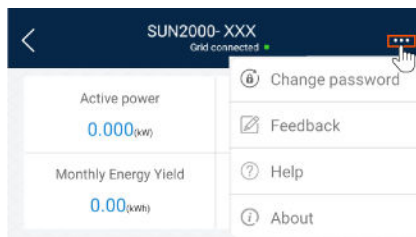
Step 4 (Optional) Tap  to upload pictures.

Step 5 (Optional) Tap  to upload logs. Select device logs or app logs as required.

Step 6 Tap **Submit**.

----End

5.6.3.3 Help

Context

If you have any questions when using an involved device or the app, search for solutions in the help information.

Procedure

Step 1 Choose  > **Help** in the upper-right corner of the home screen.

Figure 5-13 Help



Step 2 Specify your question. A solution will be displayed.

----End

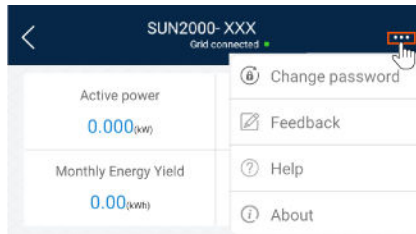
5.6.3.4 About

Context

You can query the app version, connected product model, SN, part number, firmware version, software ver., technical support website, privacy policy (displayed only on the SUN2000 app), customer service contact information, and open source software policy.

NOTE

- When the app starts for the first time after being downloaded or updated, the privacy policy is displayed. You can use the app only after agreeing to the privacy policy, and the privacy policy will no longer appear. If you do not agree to the privacy policy, the app exits, and the privacy policy is still displayed when you start the app next time until you agree to the privacy policy.
- You can revoke the agreed privacy policy.

Procedure

Step 1 In the upper-right corner of the home screen, choose  > **About** to view the app version, connected product model, SN, part number, firmware version, software version, and technical support website.

Figure 5-14 About



Step 2 Tap **Privacy policy**, **Customer service contact information**, or **Open source software policy** to view the privacy policy, customer service contact information, and open source software policy.

----End

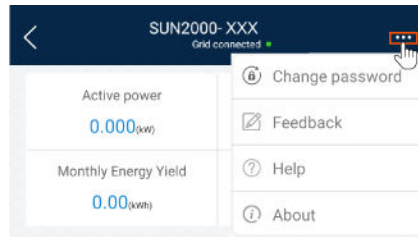
5.7 Screen Operations (Advanced User)

5.7.1 Query

Procedure

Step 1 After logging in to the app, you can view the active power and energy yield of solar inverters on the home screen.

Figure 5-15 Home screen

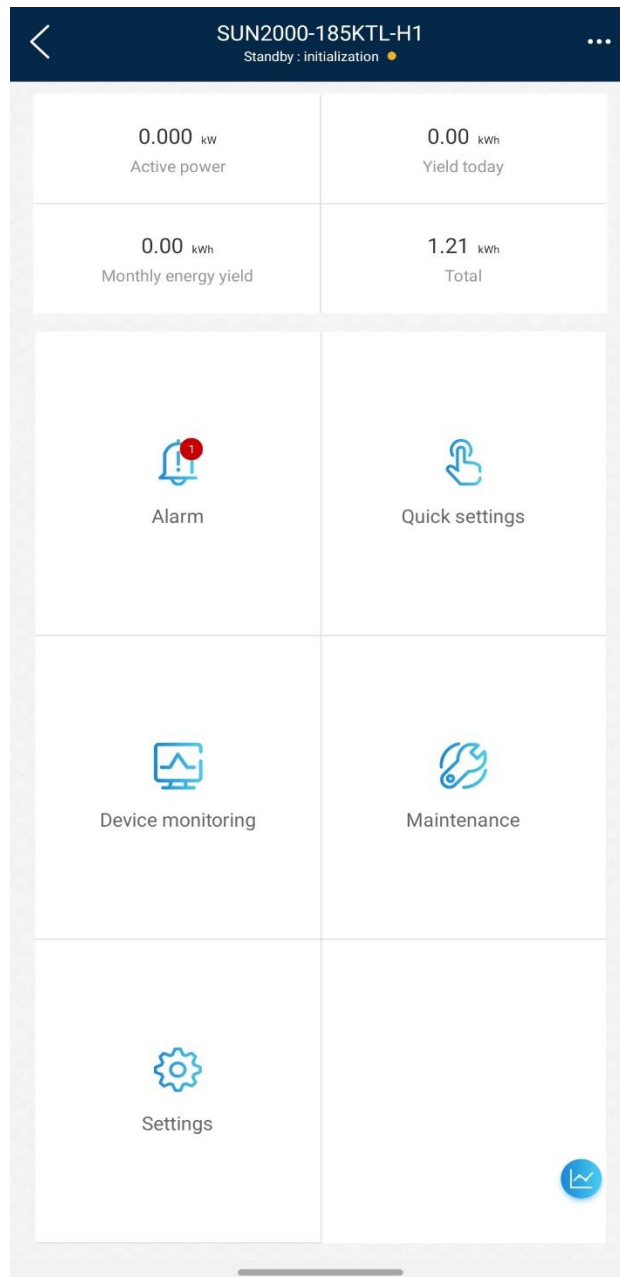

Step 2 Tap **Alarm** or **Device Monitoring** to view active alarms, historical alarms, and running information of the solar inverters.

You can view the following information on the **Alarm** screen:

- Tap an alarm record and view the alarm details.
- Tap either **Active Alarm** or **Historical Alarm** to display a list of active alarms or historical alarms.

NOTE

- Tap **Sort by generated time** to set the alarm sorting mode for active alarms or historical alarms.

- Tap  to set a time criterion. The historical alarms generated within the time segment are displayed.
- Select the alarms that can be manually cleared, and tap **Delete** on the right of the alarm to manually clear the alarms.

 **NOTE**

- Alarms that have been manually cleared can be viewed on the **Historical Alarm** screen.
- Only the **AFCI Self-Check Failure** and **DC Arc Fault** alarms can be manually cleared. Only the products whose technical specifications contain AFCI supports manual alarm clearance.

----End

5.7.2 Quick Settings

Context

Due to permission restrictions, only advanced users can quickly set up the solar inverter.

Procedure

- Step 1** On the home screen, tap **Quick settings**.

Figure 5-16 Quick settings

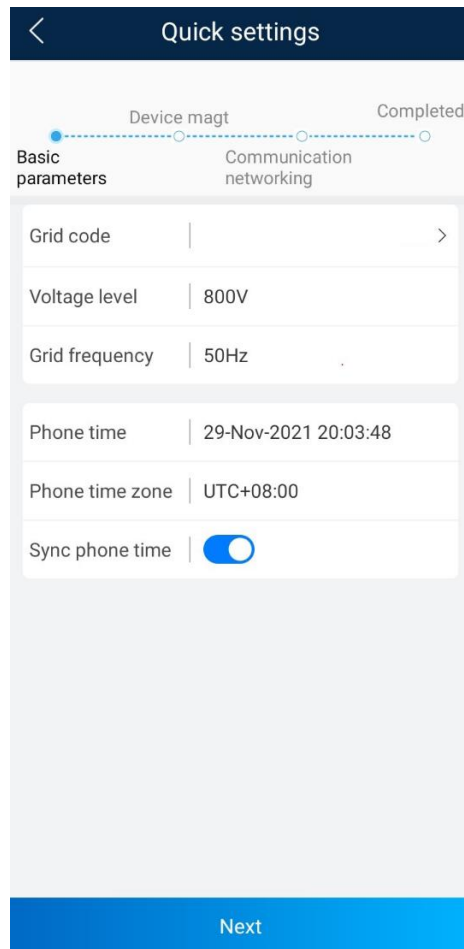

NOTE

The screenshot of **Quick settings** provided in this document is for reference only. The actual screens prevail.

Step 2 Set parameters as prompted.

----End

5.7.3 Settings

On the home screen, an advanced user can tap **Settings** to set power grid, protection, and feature parameters for the solar inverter.

Figure 5-17 Settings (advanced user)

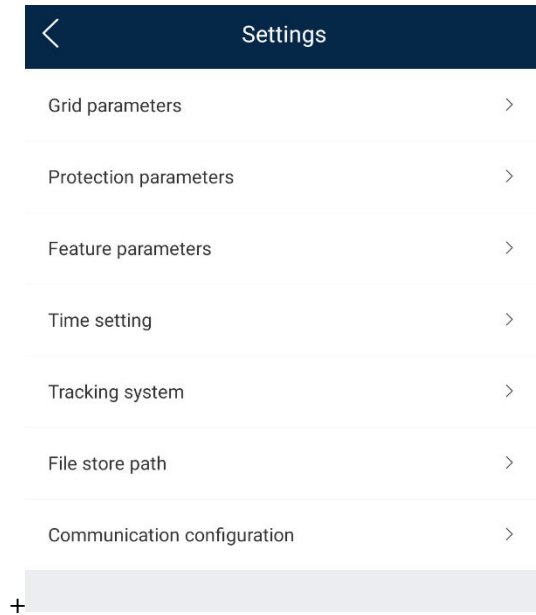

NOTICE

- The configurable solar inverter parameters vary with the solar inverter model and grid code. The displayed parameters prevail. The parameter list provided in this section includes all configurable parameters.
- The parameter ranges vary with the device model. The listed ranges are for reference only.
- The parameter names, value ranges, and default values are subject to change. The actual display prevails.

5.7.3.1 Setting Grid Parameters

Procedure

- Step 1** On the home screen, choose **Settings** > **Grid parameters** to access the parameter setting screen.

Figure 5-18 Grid parameters (advanced user)



For details about how to set the parameters, see [A Commercial Smart Inverters Parameters](#).

----End

5.7.3.2 Setting Protection Parameters

Procedure

Step 1 On the home screen, choose **Settings** > **Protection parameters** to access the parameter setting screen.

Figure 5-19 Protection parameters (advanced user)



For details about how to set the parameters, see [A Commercial Smart Inverters Parameters](#).

----End

5.7.3.3 Setting Feature Parameters

Procedure

Step 1 On the home screen, choose **Settings** > **Feature parameters** to access the parameter setting screen.

Figure 5-20 Feature parameters (advanced user)

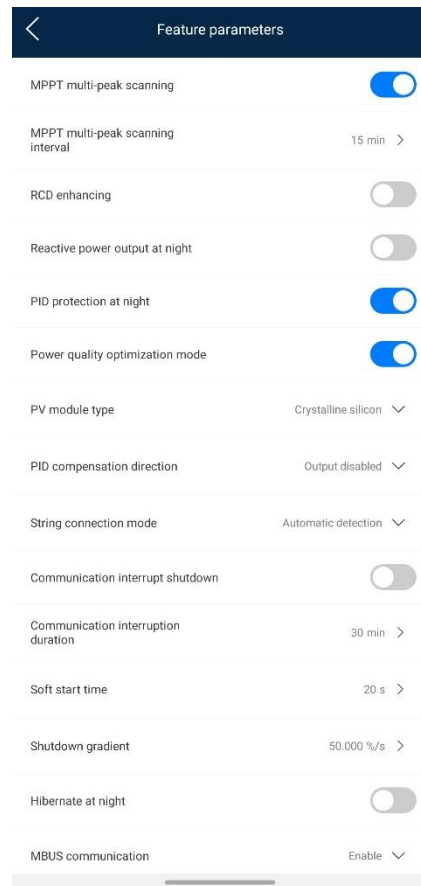

For details about how to set the parameters, see [A Commercial Smart Inverters Parameters](#).

----End

5.7.3.4 Time setting

Procedure

Step 1 On the home screen, choose **Settings** > **Time setting** and set time parameters.

Figure 5-21 Time setting (advanced user)

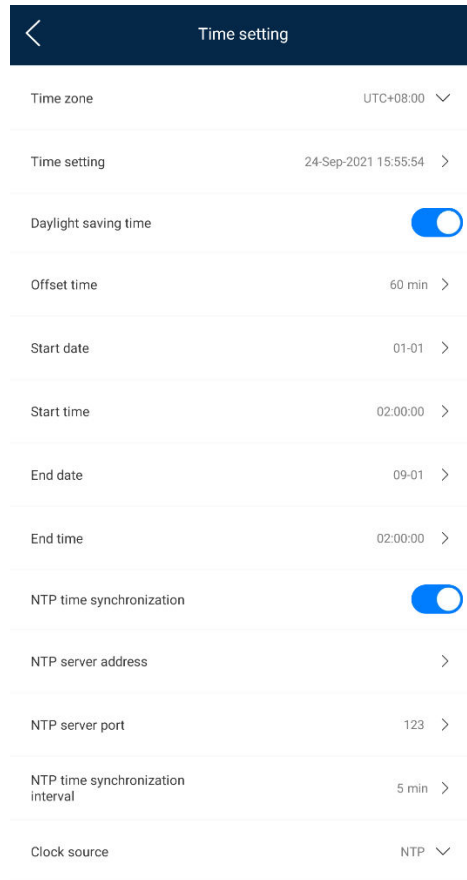

Table 5-5 Time settings

Parameter	Description
Time zone	Specifies the time zone.
Time setting	Specifies the system date and time.
Daylight saving time	Specifies whether to enable daylight saving time (DST).
Offset time	Specifies the DST offset.
Start date	Specifies the DST offset start date.
Start time	Specifies the DST offset start time.
End date	Specifies the DST offset end date.
End time	Specifies the DST offset end time.
NTP time synchronization	Specifies whether to enable NTP time synchronization.
NTP server address	Specifies the NTP server IP address or domain name.
NTP server port	Specifies the server port.

Parameter	Description
NTP time synchronization interval	Specifies the NTP time synchronization interval.

 **NOTE**

You can set DST parameters and NTP parameters.

----End

5.7.3.5 Setting Communications Parameters

Procedure

- Step 1** On the home screen, choose **Settings > Communication configuration** to access the parameter setting screen.

Figure 5-22 Communications parameters

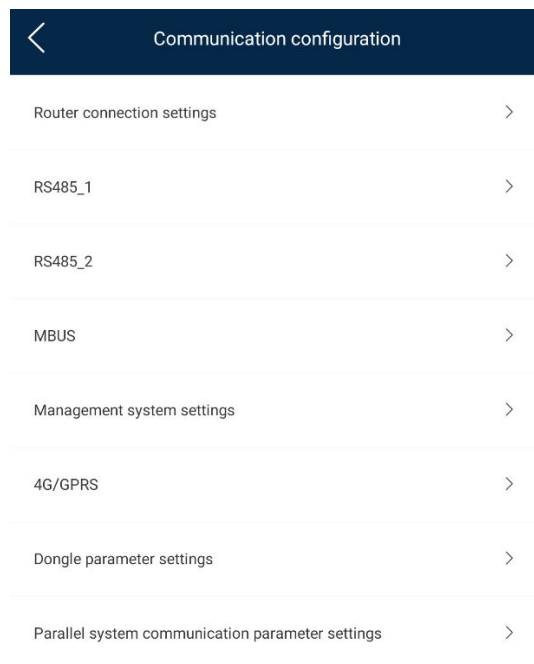



Table 5-6 Setting communications parameters

Parameter	Description
RS485_1	Set RS485 communications parameters.

Parameter	Description
RS485_2	Set RS485 communications parameters. This parameter is displayed only for the solar inverters that can connect to the RS485 slave device.
MBUS	Set MBUS communications parameters. This parameter is displayed only for the solar inverters that support the MBUS function.
Management system Settings	Set management system parameters. This parameter is displayed only for the solar inverters that can connect to the SDongle. NOTE If TLS encryption is set to  , data will be transmitted without being encrypted, which may pose security risks. Therefore, exercise caution when setting this parameter.
4G/GPRS	Set 4G/GPRS communications parameters. This parameter is displayed only for the solar inverters that can connect to the SDongle.
Dongle	Set Dongle communications parameters. This parameter is displayed only for the solar inverters that can connect to the SDongle.

 **NOTE**

You can check whether the solar inverter supports the MBUS or SDongle function by viewing the product nameplate on it.

----End

5.7.3.6 Setting a Tracking System

Context

This function is available to the 1000 V (SUN2000 V200R001C91 and SUN2000 V200R001C93 only), 1100 V, and 1500 V solar inverters. The support parameters vary depending on the controller manufacturer. Set parameters based on site requirements. The following screenshots are based on the same scenario.

Procedure

- Step 1** On the home screen, choose **Settings > Tracking System** to access the support parameter setting screen.

Figure 5-23 Tracking system

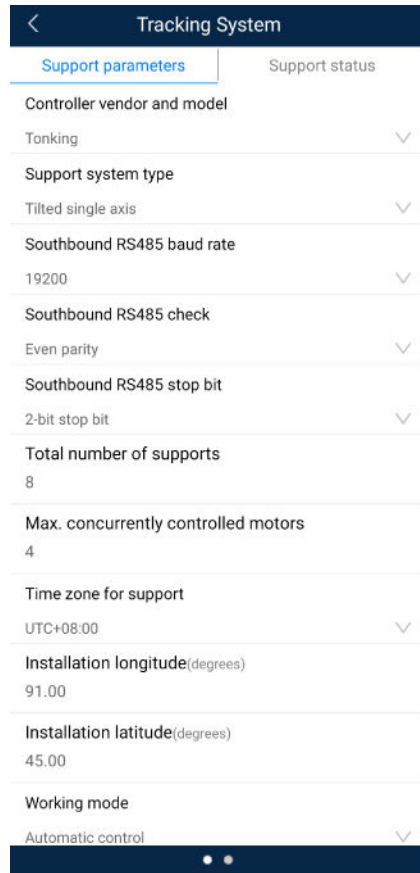

Step 2 Swipe left on the screen to access the support status screen, tap a support, and set parameters for the support.

Figure 5-24 Support



----End

5.7.3.7 Setting a File Save Path

Prerequisite

This function is available only on the Android system.

Context

You can modify the save path for operation logs and solar inverter logs and export logs from the path.

Procedure

Step 1 On the home screen, choose **Settings** > **File store path** to access the path setting screen.

Step 2 Tap **File save path** to set a file save path.

----End

5.7.4 Maintenance

An advanced user can tap **Maintenance** on the home screen to inspect, turn on, or turn off the solar inverters and detect the DC input.

Figure 5-25 Maintenance screen (advanced user)

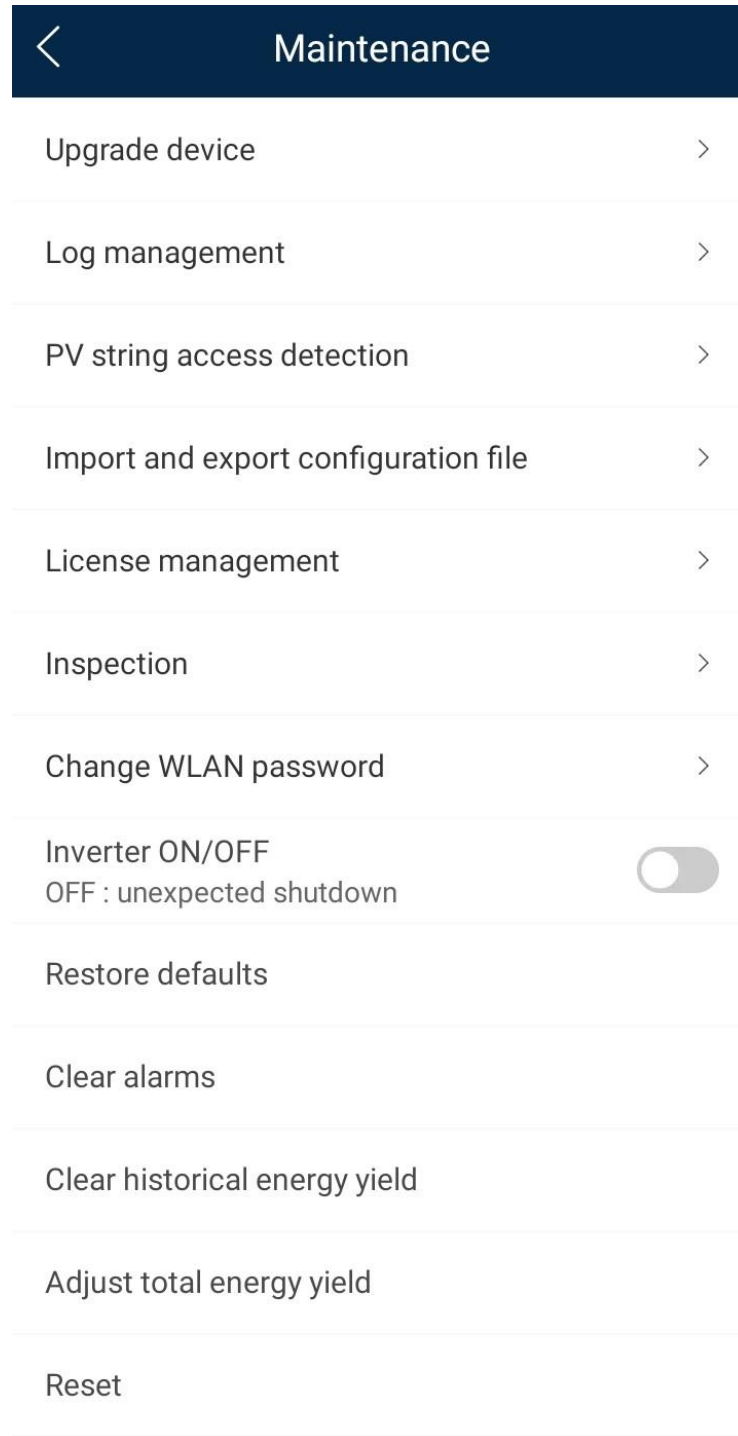

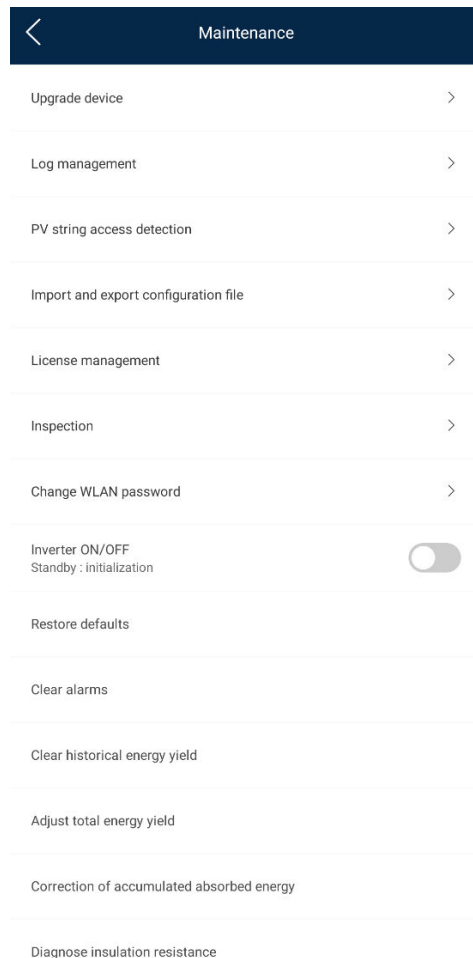

5.7.4.1 Device Inspection

Context

After a solar inverter is put into use, it should be inspected periodically to detect any potential risks and problems.

Procedure

Step 1 On the home screen, choose **Maintenance** > **Inspection** to access the inspection screen.

Figure 5-26 Device inspection



Step 2 Choose **Inspection type**, tap  in the upper-right corner of the screen to start solar inverter inspection.

Figure 5-27 Inverter Inspect



----End

5.7.4.2 License Management

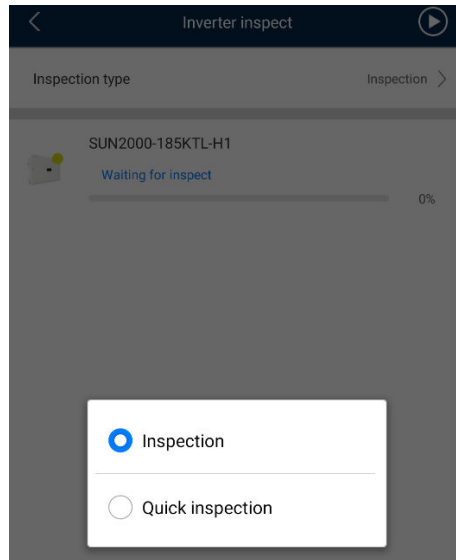
Context

The **License management** screen allows an advanced user to view the solar inverter certificate and obtain the status of the certificate.

Procedure

Step 1 On the home screen, choose **Maintenance** > **License management** to access the license management screen.

Figure 5-28 License management

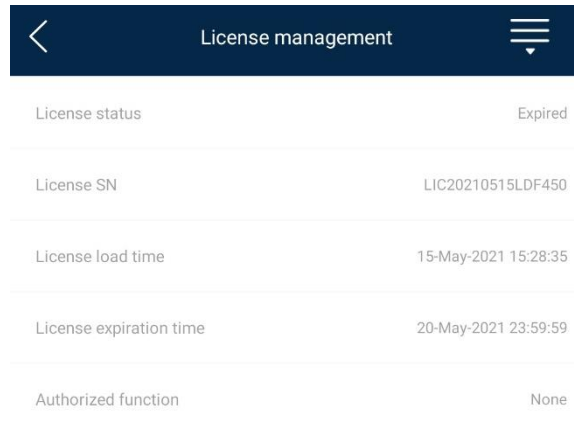

License management	
License status	Expired
License SN	LIC20210515LDF450
License load time	15-May-2021 15:28:35
License expiration time	20-May-2021 23:59:59
Authorized function	None

NOTE

- When **License status** is **Normal**, you can revoke the license through the drop-down list box in the upper-right corner.
- When **License status** is **Deregistered**, you can export and view the license revocation code.
- When **License status** is **No license**, you can load the license through the drop-down list box in the upper-right corner.

----End

5.7.4.3 PV String Access Detection

Context

- PV string access detection applies to large-scale commercial ground PV plants with PV strings facing the same direction.
- In AC or DC power limiting scenarios:
 - If the PV string access type has not been identified, **PV string access detection** will be displayed as **Not connected**. The PV string access type can be identified only when the solar inverters restore to the non-power limiting state and the current of all connected PV strings reaches the startup current.
 - If the PV string access type has been identified, when a certain PV string connected to the 2-in-1 terminals is lost, no alarm will be generated. If a certain PV string connected to the 2-in-1 terminals is restored, the access type cannot be identified. You can determine whether both 2-in-1 PV strings are restored only when the PV string current reaches **Startup current for 2-in-1 detection**.
- After setting the parameters, on the home screen, choose Device monitoring > **Details** to check whether the PV string access status is normal.

Procedure

- Step 1** On the home screen, choose **Maintenance > PV string access detection** and set PV string access detection parameters.

Figure 5-29 PV string access detection



Figure 5-30

Table 5-7 PV string access detection

Parameter	Description
PV string access detection	PV string access detection is set to Disable by default. After solar inverters are connected to the power grid, set PV string access detection to Enable .
Startup current (A)	When the current of all connected PV strings reaches the preset value, the PV string access detection function is enabled. NOTE Startup current setting rules: <ul style="list-style-type: none"> Startup current = $I_{sc} (S_{tc}) \times 0.6$ (rounded up). For details about $I_{sc} (S_{tc})$, see the PV module nameplate. Default startup current (5 A): applicable to the scenarios where the short-circuit current $I_{sc} (S_{tc})$ is greater than 8 A for the monocrystalline and polycrystalline PV modules.
Startup current for 2-in-1 detection (A)	When the current of a PV string reaches Startup current for 2-in-1 detection , the PV string is automatically identified as 2-in-1 string. You are advised to retain the default settings.
PV string <i>N</i> access type NOTE <i>N</i> is the DC input terminal number of the solar inverter.	Set this parameter based on the type of the PV string connected to DC input terminal <i>N</i> of the solar inverter. You are advised to retain the default value. If the value is incorrectly set, the PV string access type may be incorrectly identified and alarms may be generated by mistake for the PV string access status.

----End

5.7.4.4 Startup and Shutdown

Procedure

Step 1 On the home screen, tap **Maintenance** to access the maintenance screen.



Step 2 Tap  next to **Inverter ON/OFF** to perform the operation.

Step 3 Enter the password for logging in to the app, and tap **Confirm**.

----End

5.7.4.5 Restoring Factory Settings

Context

NOTICE

Perform this operation with caution because all configured parameters except the current date, time, baud rate, and address will be restored to their factory default values. This operation will not affect operating information, alarm records, or system logs.

Procedure

Step 1 On the home screen, tap **Maintenance** to access the maintenance screen.

Step 2 Tap **Restore defaults** to perform the operation.

Step 3 Enter the password for logging in to the app, and tap **Confirm**.

----End

5.7.4.6 Resetting a Solar Inverter

Context

The solar inverter automatically shuts down and restarts after reset.

Procedure

Step 1 On the home screen, tap **Maintenance** to access the maintenance screen.

Step 2 Tap **Reset** to perform the operation.

Step 3 Enter the password for logging in to the app, and tap **Confirm**.

----End

5.7.4.7 Clearing Alarms

Context

After alarms are reset, all active alarms and historical alarms of the solar inverter connected to the app will be cleared.

Procedure

- Step 1** On the home screen, tap **Maintenance** to access the maintenance screen.
 - Step 2** Tap **Clear alarms** to perform the operation.
 - Step 3** Enter the password for logging in to the app, and tap **Confirm**.
- End

5.7.4.8 Clearing Historical Energy Yield Data

Context

If you clear historical energy yield data, all the historical energy yield data of the solar inverters connecting to the app will be cleared.

Procedure

- Step 1** On the home screen, tap **Maintenance** to access the maintenance screen.
 - Step 2** Tap **Clear historical energy yield**.
 - Step 3** Enter the password for logging in to the app, and tap **Confirm**.
- End

5.7.4.9 Importing and Exporting Configuration Files

Procedure

1. On the home screen, choose **Maintenance > Import and export configuration file** to access the screen for configuration file import and export.
 - Tap **Export Configuration File** to export the configuration files of the solar inverter to the phone.
 - Tap **Import Configuration File** to import the configuration files from the phone to the solar inverter.

5.7.4.10 Spot-Check

Context

You can perform spot-check for the solar inverter whose **Grid Code** is **Japan standard**.

Procedure

- Step 1** On the home screen, tap **Spot-check** to access the spot-check screen.

Figure 5-31 Spot-Check

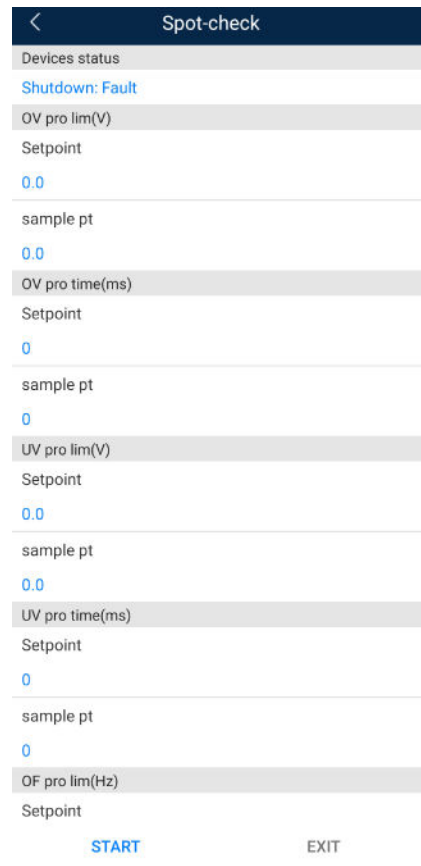

Step 2 Tap **START**.

----End

5.7.4.11 Device Upgrade

Prerequisites

- You have obtained the upgrade package with the help of the supplier or Huawei engineers. After the downloading is complete, use the digital certificate and verification tool available at Huawei technical support website to verify the digital signature of the software package.
 - a. Log in to Huawei enterprise technical support website <http://support.huawei.com/enterprise>.
 - b. Browse or search for **PGP Verify**.
- In the Android system, you have copied the upgrade package has been copied to the Android/data/com.huawei.inverterapp/files/ directory on the mobile phone. The upgrade package is a .zip file.

Procedure

Step 1 On the home screen, choose **Maintenance > Upgrade device**.

Step 2 Access the device upgrade screen and tap **Upgrade**.

Figure 5-32 Device upgrade



Step 3 Perform operations as prompted.

----End

5.7.4.12 Log management

Context

You can tap **Log management** to export operation logs, as well as alarm records and energy yield information of the solar inverter from the mobile phone.

Procedure

Step 1 On the home screen, choose **Maintenance > Log management** to access the log download screen.

Figure 5-33 Downloading logs

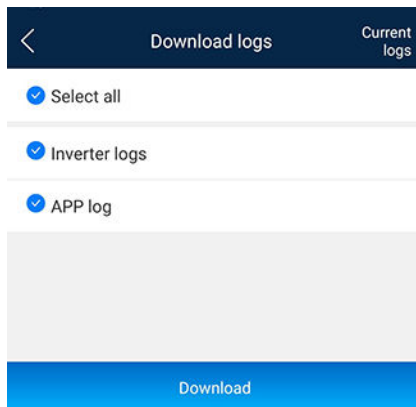

Step 2 You can download **Inverter logs** and **APP log**.

NOTE

- By default, Android system logs are saved in the **Android/data/com.huawei.inverterapp/files/inverterapp** folder in the phone memory. You can change the save path by referring to "Setting a File Save Path".
- The downloaded solar inverter logs are saved at the **Device Log** directory in **File Management** in your mobile phone. You can also send the logs to your mailbox for checking.

----End

5.7.4.13 Changing the WLAN Password

Context

You can tap **Maintenance** on the home screen to change the WLAN password to ensure account security.

 **NOTE**

If the communication between the app and the solar inverter has not been established over WLAN, **Change WLAN Password** is not displayed on the screen.

Procedure

Step 1 On the **Maintenance** screen, tap **Change WLAN Password** on the app connection screen to access the password change screen.

Step 2 Specify **Old password**, **New password**, and **Confirm password**, and then tap **Submit**.

 **NOTE**

The password must meet the following requirements:

- Contains 8–30 characters.
- Contains at least two of the three types: lowercase letters, uppercase letters, and digits.

----End

5.7.4.14 Feedback

Context

Users can provide feedback in text, pictures, and files.

 **NOTE**

Do not add private data.

Procedure

Step 1 Choose  > **Feedback** in the upper-right corner of the home screen.

Figure 5-34 Feedback



Step 2 Tap **Specify the type** and select **Feedback** or **Suggestion**.

Step 3 Briefly describe the problem that you encounter in the **Description** column.

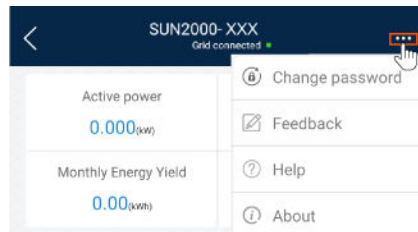
Step 4 (Optional) Tap  to upload pictures.

Step 5 (Optional) Tap  to upload logs. Select device logs or app logs as required.

Step 6 Tap **Submit**.

----End

5.7.4.15 Help

Context

If you have any questions when using an involved device or the app, search for solutions in the help information.

Procedure

Step 1 Choose  > **Help** in the upper-right corner of the home screen.

Figure 5-35 Help



Step 2 Specify your question. A solution will be displayed.

----End

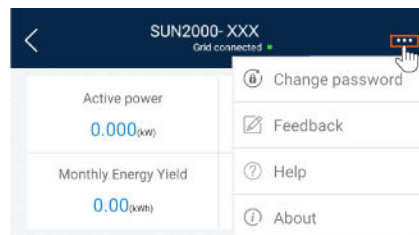
5.7.4.16 About

Context

You can query the app version, connected product model, SN, part number, firmware version, software ver., technical support website, privacy policy (displayed only on the SUN2000 app), customer service contact information, and open source software policy.

NOTE

- When the app starts for the first time after being downloaded or updated, the privacy policy is displayed. You can use the app only after agreeing to the privacy policy, and the privacy policy will no longer appear. If you do not agree to the privacy policy, the app exits, and the privacy policy is still displayed when you start the app next time until you agree to the privacy policy.
- You can revoke the agreed privacy policy.

Procedure

- Step 1** In the upper-right corner of the home screen, choose  > **About** to view the app version, connected product model, SN, part number, firmware version, software version, and technical support website.

Figure 5-36 About



- Step 2** Tap **Privacy policy**, **Customer service contact information**, or **Open source software policy** to view the privacy policy, customer service contact information, and open source software policy.

----End

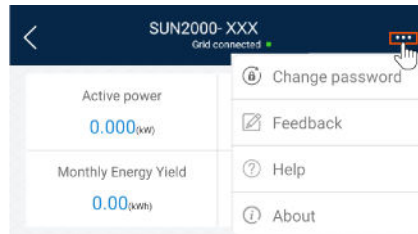
5.8 Screen Operations (Special User)

5.8.1 Query

Procedure

- Step 1** After logging in to the app, you can view the active power and energy yield of solar inverters on the home screen.

Figure 5-37 Home screen

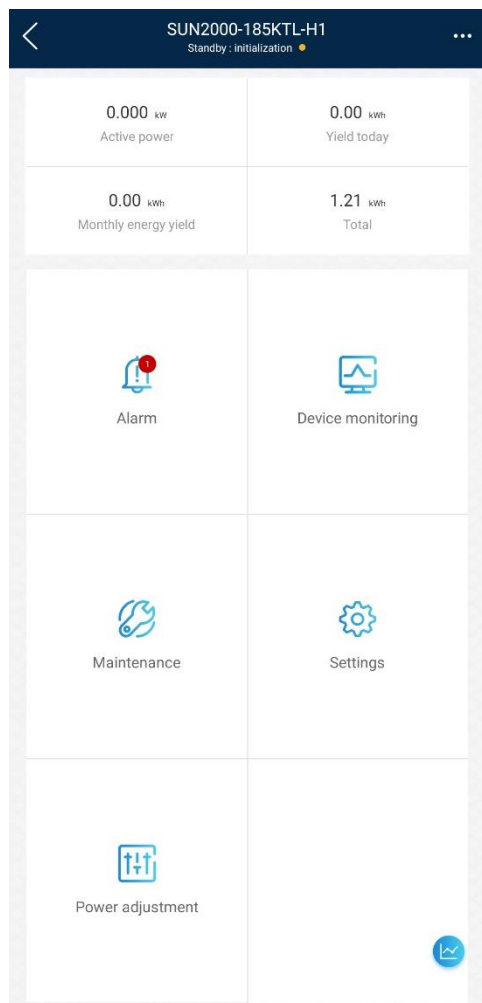

Step 2 Tap **Alarm** or **Device Monitoring** to view active alarms, historical alarms, and running information of the solar inverters.

You can view the following information on the alarm management screen:

- Tap an alarm record and view the alarm details.
- Tap either **Active Alarm** or **Historical Alarm** to display a list of active alarms or historical alarms.

 **NOTE**

- Tap **Sort by generated time** to set the alarm sorting mode for active alarms or historical alarms.
- Tap  to set a time criterion. The historical alarms generated within the time segment are displayed.
- Select the alarms that can be manually cleared, and tap **Delete** on the right of the alarm to manually clear the alarms.

 **NOTE**

- Alarms that have been manually cleared can be viewed on the **Historical Alarm** screen.

- Only the **AFCI Self-Check Failure** and **DC Arc Fault** alarms can be manually cleared. Only the products whose technical specifications contain AFCI supports manual alarm clearance.

----End

5.8.2 Settings

On the home screen, a special user can tap **Settings** to set power grid, protection, and feature parameters for the solar inverter.

Figure 5-38 Settings (special user)

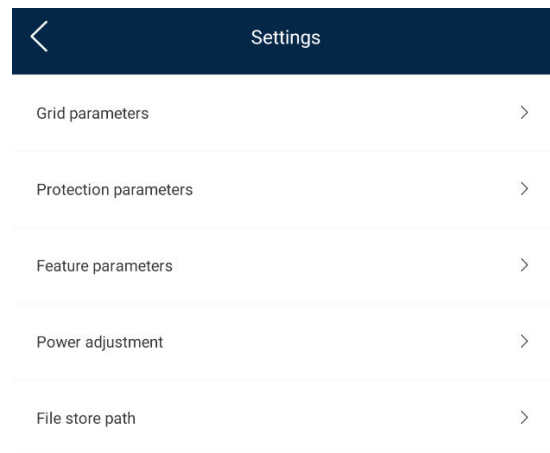

NOTICE

- The configurable solar inverter parameters vary with the solar inverter model and grid code. The displayed parameters prevail. The parameter list provided in this section includes all configurable parameters.
- The parameter ranges vary with the device model. The listed ranges are for reference only.
- The parameter names, value ranges, and default values are subject to change. The actual display prevails.

5.8.2.1 Setting Grid Parameters

Procedure

- Step 1** On the home screen, choose **Settings** > **Grid parameters** to access the parameter setting screen.

Figure 5-39 Grid parameters (special user)

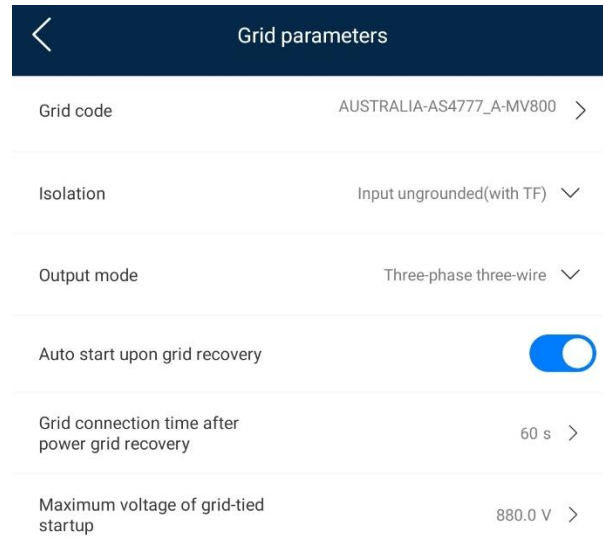

For details about how to set the parameters, see [A Commercial Smart Inverters Parameters](#).

----End

5.8.2.2 Setting Protection Parameters

Procedure

- Step 1** On the home screen, choose **Settings** > **Protection parameters** to access the parameter setting screen.

Figure 5-40 Protection parameters (special user)

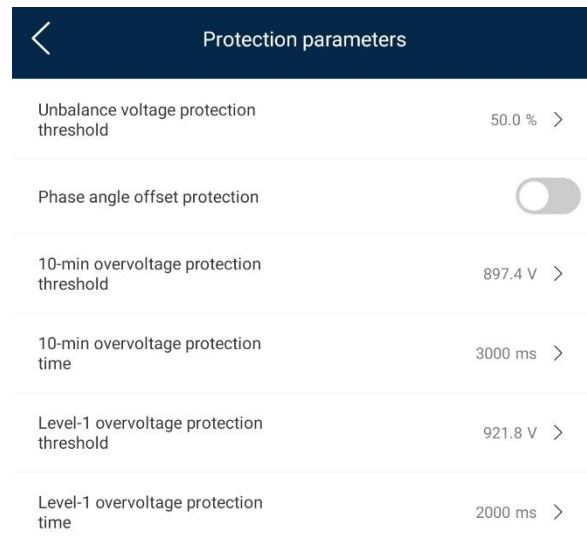

For details about how to set the parameters, see [A Commercial Smart Inverters Parameters](#).

----End

5.8.2.3 Setting Feature Parameters

Procedure

Step 1 On the home screen, choose **Settings > Feature parameters** to access the parameter setting screen.

Figure 5-41 Feature parameters (special user)

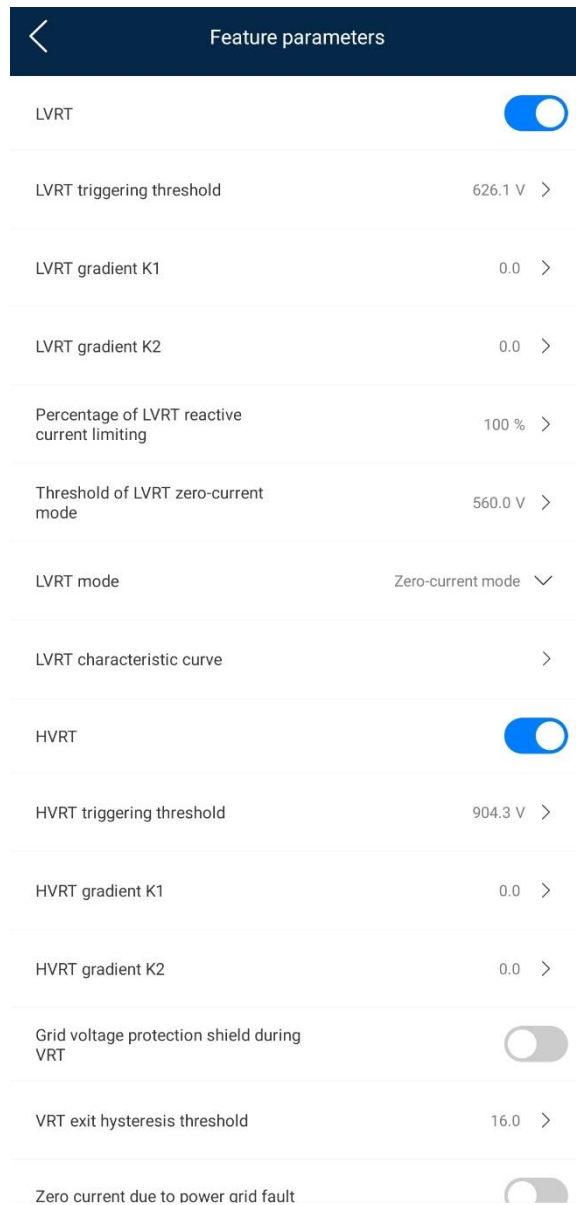

For details about how to set the parameters, see [A Commercial Smart Inverters Parameters](#).

----End

5.8.2.4 Setting Power Adjustment Parameters

Procedure

Step 1 On the home screen, choose **Settings > Power adjustment** to access the parameter setting screen.

Figure 5-42 Power adjustment parameters (special user)

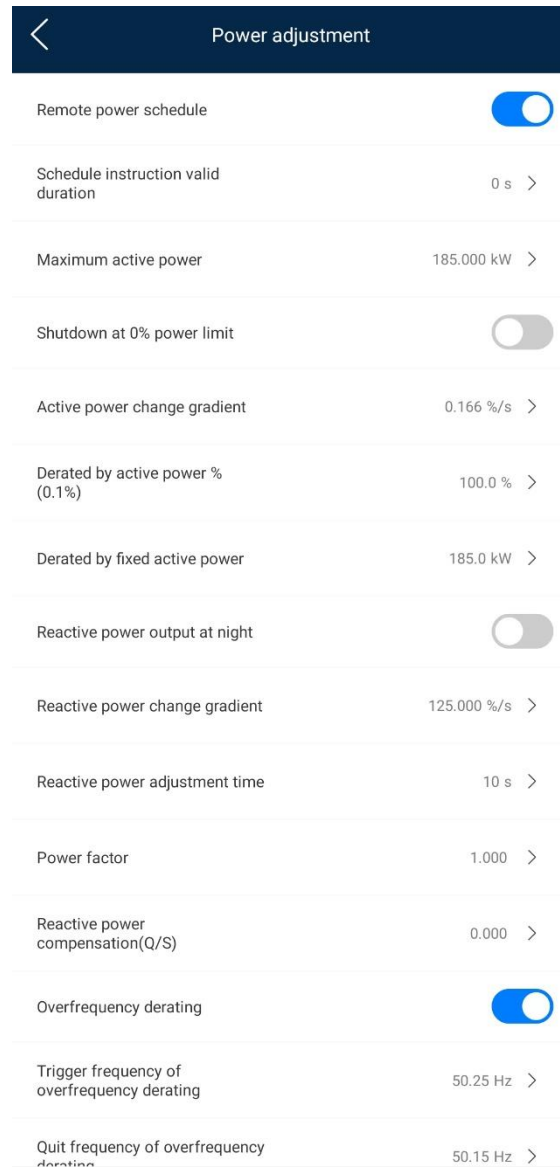

For details about how to set the parameters, see [A Commercial Smart Inverters Parameters](#).

----End

5.8.2.5 Setting a File Save Path

Prerequisite

This function is available only on the Android system.

Context

You can modify the save path for operation logs and solar inverter logs and export logs from the path.

Procedure

Step 1 On the home screen, choose **Settings** > **File store path** to access the path setting screen.

Step 2 Tap **File save path** to set a file save path.

----End

5.8.3 Power Adjustment

Context

Due to permission restrictions, special users support the setting of power adjustment, which can set the active power, reactive power, and grid connection point control parameters of the solar inverter.

Procedure

Step 1 On the home screen, tap **Power adjustment**.

Figure 5-43 Power adjustment



Step 2 Set power parameters as required.

For details about how to set the parameters, see [A Commercial Smart Inverters Parameters](#).

----End

5.8.4 Maintenance

On the home screen, a special user can tap **Maintenance** to start or shut down the solar inverter and restore factory settings.

Figure 5-44 Maintenance (special user)

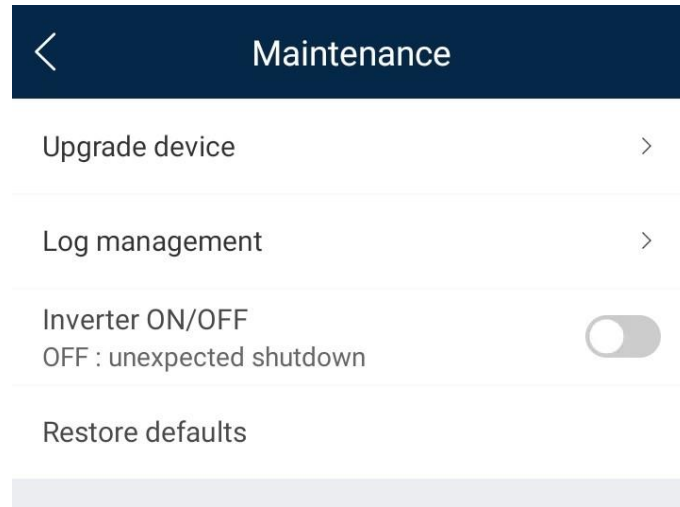

5.8.4.6 Startup and Shutdown

Procedure

Step 1 On the home screen, tap **Maintenance** to access the maintenance screen.



Step 2 Tap next to **Inverter ON/OFF** to perform the operation.

Step 3 Enter the password for logging in to the app, and tap **Confirm**.

----End

5.8.4.7 Restoring Factory Settings

Context

NOTICE

Perform this operation with caution because all configured parameters except the current date, time, baud rate, and address will be restored to their factory default values. This operation will not affect operating information, alarm records, or system logs.

Procedure

Step 1 On the home screen, tap **Maintenance** to access the maintenance screen.

Step 2 Tap **Restore defaults** to perform the operation.

Step 3 Enter the password for logging in to the app, and tap **Confirm**.

----End

5.8.4.8 Device Upgrade

Prerequisites

- You have obtained the upgrade package with the help of the supplier or Huawei engineers. After the downloading is complete, use the digital certificate and verification tool available at Huawei technical support website to verify the digital signature of the software package.
 - a. Log in to Huawei enterprise technical support website <http://support.huawei.com/enterprise>.
 - b. Browse or search for **PGP Verify**.
- In the Android system, you have copied the upgrade package to the `Android/data/com.huawei.inverterapp/files/` directory on the mobile phone. The upgrade package is a .zip file.

Procedure

Step 1 On the home screen, choose **Maintenance > Upgrade device**.

Step 2 Access the device upgrade screen and tap **Upgrade**.

Figure 5-45 Device upgrade

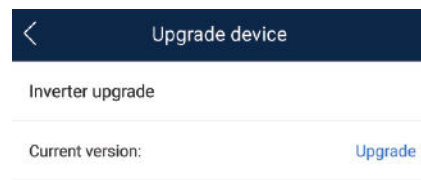

Step 3 Perform operations as prompted.

----End

5.8.4.9 Log management

Context

You can tap **Log management** to export operation logs, as well as alarm records and energy yield information of the solar inverter from the mobile phone.

Procedure

Step 1 On the home screen, choose **Maintenance > Log management** to access the log download screen.

Figure 5-46 Downloading logs

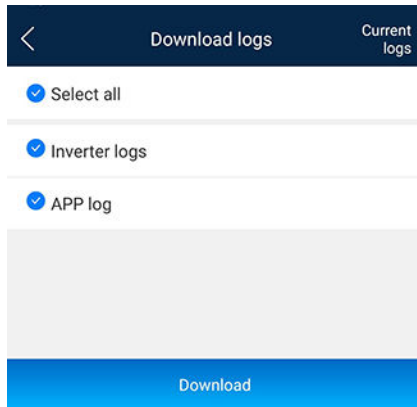

Step 2 You can download **Inverter logs** and **APP log**.

NOTE

- By default, Android system logs are saved in the **Android/data/com.huawei.smartpvms/files/inverterapp** folder in the phone memory. You can change the save path by referring to "Setting a File Save Path".
- The downloaded solar inverter logs are saved at the **Device Log** directory in **File Management** in your mobile phone. You can also send the logs to your mailbox for checking.

----End

5.8.4.10 Feedback

Context

Users can provide feedback in text, pictures, and files.

NOTE

Do not add private data.

Procedure



Step 1 Choose  > **Feedback** in the upper-right corner of the home screen.

Figure 5-47 Feedback

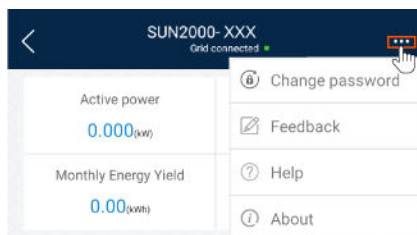

Step 2 Tap **Specify the type** and select **Feedback** or **Suggestion**.

Step 3 Briefly describe the problem that you encounter in the **Description** column.

Step 4 (Optional) Tap  to upload pictures.

Step 5 (Optional) Tap  to upload logs. Select device logs or app logs as required.

Step 6 Tap **Submit**.

----End

5.8.4.11 Help

Context

If you have any questions when using an involved device or the app, search for solutions in the help information.

Procedure

Step 1 Choose  > **Help** in the upper-right corner of the home screen.

Figure 5-48 Help



Step 2 Specify your question. A solution will be displayed.

----End

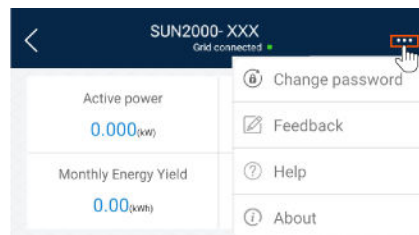
5.8.4.12 About

Context

You can query the app version, connected product model, SN, part number, firmware version, software ver., technical support website, privacy policy (displayed only on the SUN2000 app), customer service contact information, and open source software policy.

NOTE

- When the app starts for the first time after being downloaded or updated, the privacy policy is displayed. You can use the app only after agreeing to the privacy policy, and the privacy policy will no longer appear. If you do not agree to the privacy policy, the app exits, and the privacy policy is still displayed when you start the app next time until you agree to the privacy policy.
- You can revoke the agreed privacy policy.

Procedure

- Step 1** In the upper-right corner of the home screen, choose  > **About** to view the app version, connected product model, SN, part number, firmware version, software version, and technical support website.

Figure 5-49 About



- Step 2** Tap **Privacy policy**, **Customer service contact information**, or **Open source software policy** to view the privacy policy, customer service contact information, and open source software policy.

----End

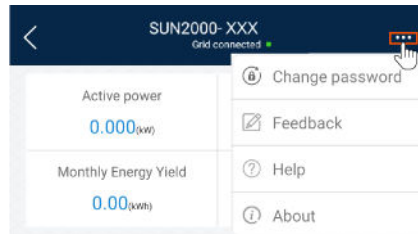
6 Operations on the Screen for Connecting to the SmartLogger

6.1 SmartLogger

Connection Modes

- The SmartLogger2000 has a built-in Bluetooth module. The app can be connected to the SmartLogger2000 over Bluetooth after the SmartLogger2000 is powered on.
- The SmartLogger1000A/SmartLogger3000 has a built-in WLAN module. The app can be connected to the SmartLogger1000A/SmartLogger3000 over WLAN after the SmartLogger1000A/SmartLogger3000 is powered on.

Table 6-1 Product mapping

SmartLogger	SmartLogger Version	App Version	Bluetooth Connection	WLAN Connection
SmartLogger3000	SmartLogger V300R001C00 and later versions	3.2.00.005	-	Supported
SmartLogger2000	SmartLogger V200R001C00S PC103 and later versions		Supported	-
	SmartLogger V200R001C10S PC010 and later versions			
	SmartLogger V200R001C30 and later versions			
	SmartLogger V200R002C10 and later versions			
	SmartLogger			

SmartLogger	SmartLogger Version	App Version	Bluetooth Connection	WLAN Connection
	V200R002C20 and later versions			
SmartLogger1000A	SmartLogger V100R002C00 and later versions		-	Supported

6.2 User Operation Permissions

For SmartLogger2000 and SmartLogger1000A, the user accounts that can log in to the app are classified into common users, special users, and advanced users. You can set different user permissions based on the responsibilities of PV plant operation personnel.

- Common users: Has the permissions of viewing data about the SmartLogger and the devices connected to it, setting SmartLogger user parameters, and changing the system password.
- Advanced users: Has the permissions of viewing data about the SmartLogger and the devices connected to it, setting functional parameters, managing devices, and maintaining the system.
- Special users: Has the permissions of viewing data about the SmartLogger and the devices connected to it, managing devices, and maintaining the system.

For SmartLogger3000, the user accounts that can log in to the app are classified into installer and user, user permissions can refer to common users permissions, and installer permissions can refer to advanced users permissions and special users permissions.

[Figure 6-1](#), [Figure 6-2](#), and [Figure 6-3](#) show the menu operation permissions of common users, special users, and advanced users respectively.

Figure 6-1 Operation permissions of common users

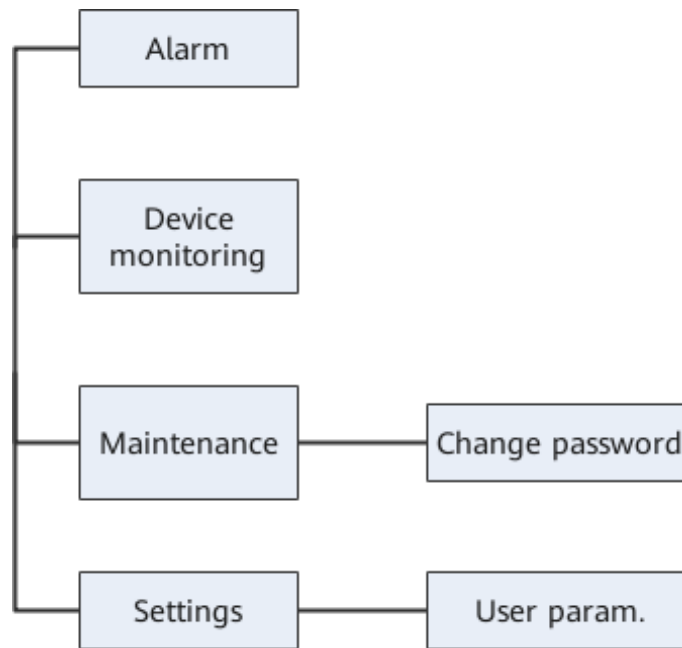

NOTE

Common users can view data and start or shut down the devices under **Monitoring**.

Figure 6-2 Operation permissions of advanced users

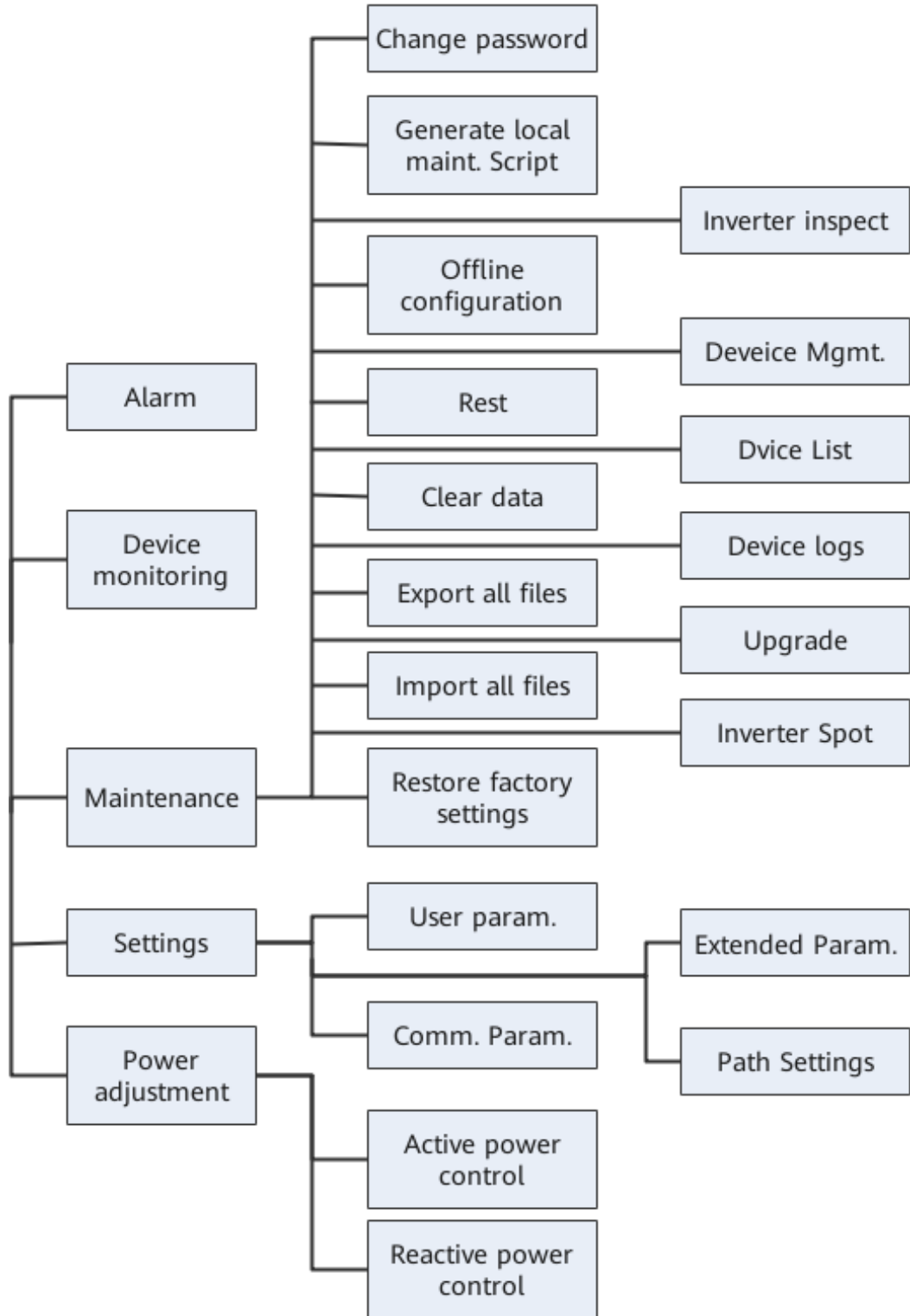

NOTE

- Advanced users can view data, set parameters, download logs, and start or shut down the devices under **Monitoring**.
- **Path Settings** is available only to the Android system.

Figure 6-3 Operation permissions of special users

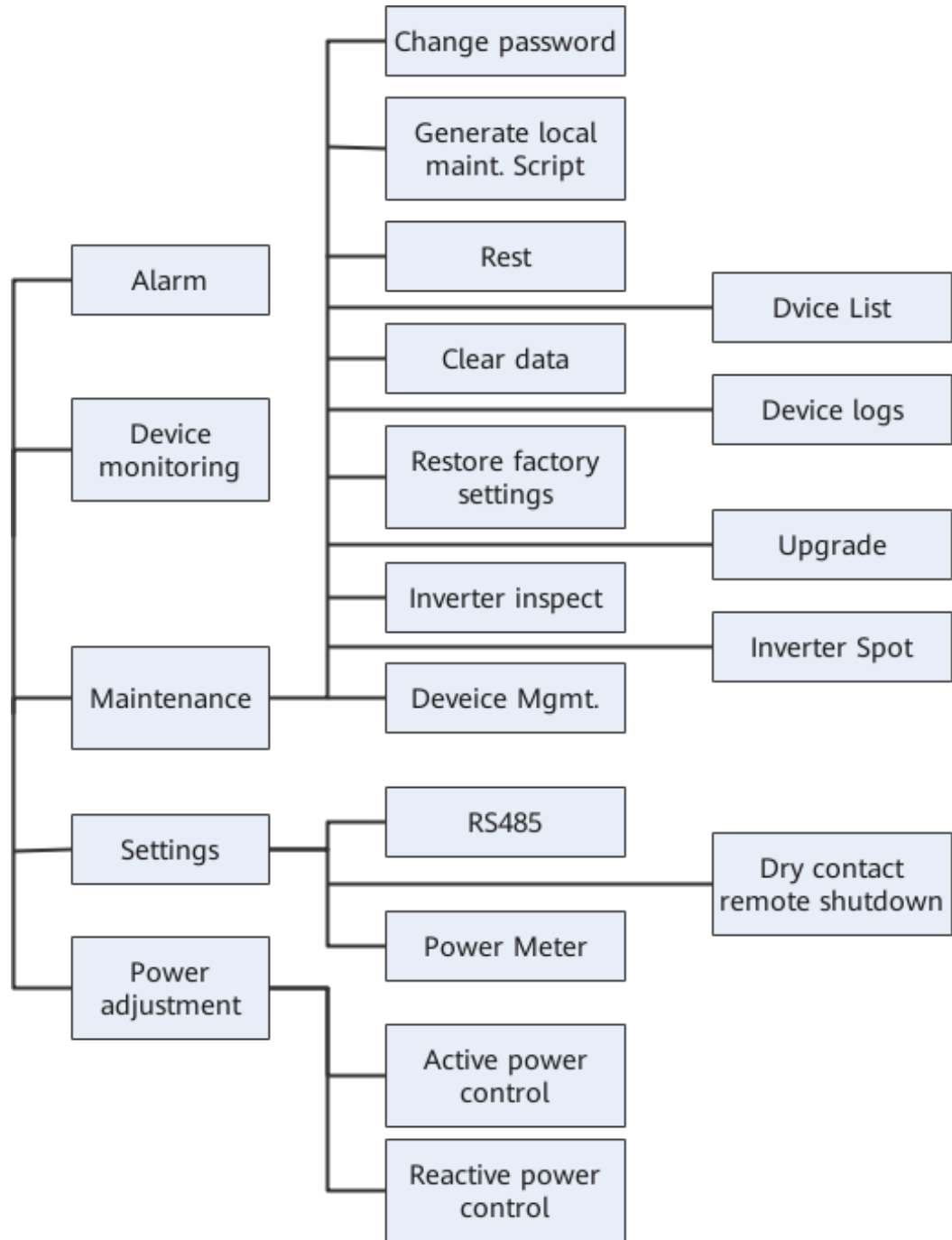

NOTE

Special users can view data, download logs, and start or shut down the devices under **Monitoring**.

6.3 Login

Prerequisites

- The SmartLogger has been powered on.
- The Bluetooth function of the SmartLogger is enabled by default.
- The WLAN function of the SmartLogger is disabled by default. Ensure that the WLAN function is enabled before connecting to the SmartLogger.
- Connect over a WLAN/Bluetooth:
 - a. The WLAN/Bluetooth function is enabled on the mobile phone.
 - b. Keep the mobile phone within 5 m from the SmartLogger. Otherwise, the communication between them would be affected.

Procedure

Step 1 Connect to the SmartLogger.

Figure 6-4 Connect

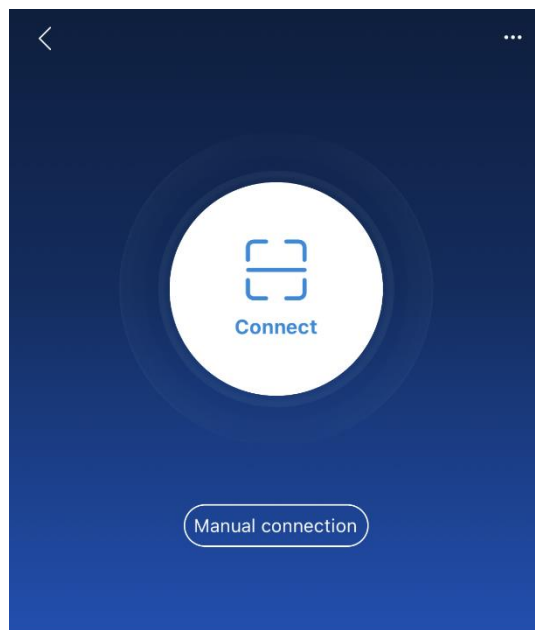

Connection record

- Code scanning: Tap **Connect**, on the scanning screen, place the QR code of the Device in the scan frame. The device will be automatically connected after the code is identified.
- Manual connection: Tap **Manual Connection** and select a connection mode.

Figure 6-5 Manual connection



- Select **WLAN** and connect the SmartLogger1000A or SmartLogger3000 to the corresponding WLAN in the WLAN connection list of the APP. The initial name of the WLAN is **Logger_SN bar code**, and the initial password is **Changeme**.

NOTICE

- Use the initial password upon first power-on and change it immediately after login. To ensure account security, change the password periodically and keep the new password in mind. Not changing the initial password may cause password disclosure. A password left unchanged for a long period of time may be stolen or cracked. If a password is lost, the device needs to be restored to its factory settings. In these cases, the user is liable for any loss caused to the PV plant.
- If the **This WLAN network has no Internet access. Connect anyway?** message is displayed when you connect to the built-in WLAN, tap **CONNECT**. Otherwise, you cannot log in to the system. The actual UI and messages may vary with mobile phones.

- Select **Bluetooth**, and tap **Search for Device**. After a Bluetooth device is found, select the target Bluetooth device, and set up a connection. When the Bluetooth connection is used for the SmartLogger2000, the name of the connected Bluetooth device is **LOG+last eight digits of the SN bar code**.

Step 2 Select a login user and enter the password, tap **Log In**.

Figure 6-6 Login

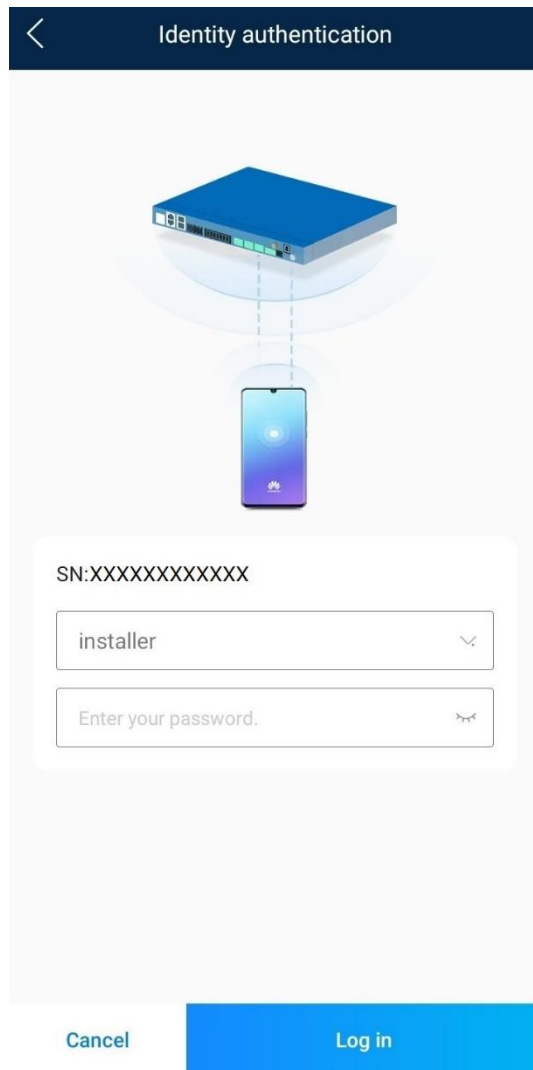

NOTICE

- The login password is the same as that for the SmartLogger connected to the app and is used only when the SmartLogger connects to the app.
- For SmartLogger1000A and SmartLogger2000, the initial passwords for **Common User**, **Advanced User**, and **Special User** are all **00000a**.
- For SmartLogger3000, the initial passwords for **installer** and **user** are all **00000a**.
- Use the initial password upon first power-on and change it immediately after login. To ensure account security, change the password periodically and keep the new password in mind. Not changing the initial password may cause password disclosure. A password left unchanged for a long period of time may be stolen or cracked. If a password is lost, devices cannot be accessed. In these cases, the user is liable for any loss caused to the PV plant.
- During the login, if five consecutive invalid password entries are made (the interval between two consecutive entries is less than 2 minutes), the account will be locked for 10 minutes. The password should consist of six characters.

Step 3 After successful login, the quick settings screen or home screen is displayed.

NOTE

- If you log in to the app after the SmartLogger powers on for the first time or the SmartLogger factory defaults are restored, the quick settings screen will be displayed. You can set basic parameters for the SmartLogger on the **Quick Settings** screen. After the setting, you can modify the parameters after choosing **MoreSettings**.
- If you do not set basic parameters for the SmartLogger on the **Quick Settings** screen, the screen is still displayed when you log in to the app next time.

----End

6.4 Screen Operations (Common User)

6.4.1 Query

Procedure

Step 1 After logging in to the app, you can view the active power and energy yield of the connected solar inverters on the home screen.

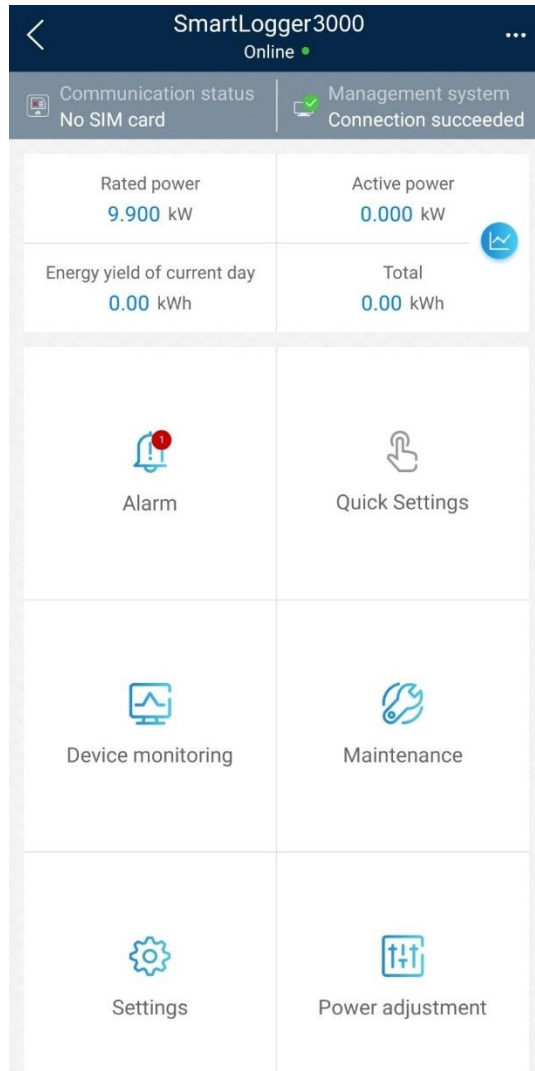

Step 2 Tap **Alarm management** or **Device Monitoring** to view active alarms, historical alarms, and running information.

You can view the following information on the alarm management screen:

- Tap an alarm record and view the alarm details.
- Swipe right or left on the screen or tap either **Active Alarm** or **Historical Alarm** to display a list of active alarms or historical alarms.
- Select the alarms that can be manually cleared, and tap **Delete** on the right of the alarm to manually clear the alarms.

----End

6.4.2 Settings

A common user can choose **Settings** to set user parameters for the SmartLogger.

Figure 6-7 Settings (Common User)

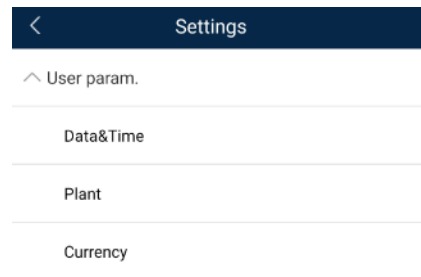

6.4.2.1 Setting the System Date and Time

Procedure

Step 1 Choose **Settings** > **User param.** > **Date&Time** to set the date and time.

Figure 6-8 Date&Time screen

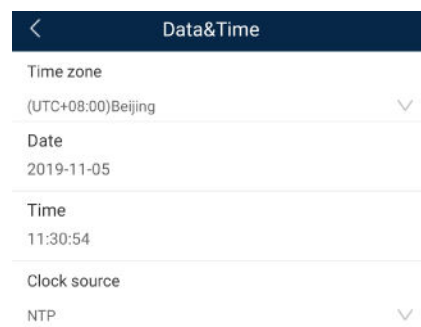

Step 2 Set the date and time based on the region where the SmartLogger is located.

 **NOTE**

For a solar inverter that supports DST, if an advanced user enables DST, a common user can view DST data. The displayed parameters are for reference only.

----End

6.4.2.2 Setting Plant Information

Step 1 Choose **Settings** > **User param.** > **Plant** to access the parameter setting screen.

Figure 6-9 Plant

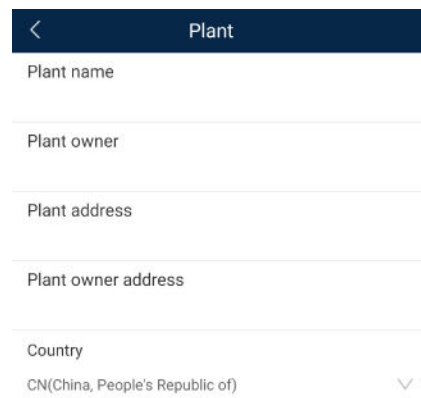

Plant	
Plant name	
Plant owner	
Plant address	
Plant owner address	
Country	CN(China, People's Republic of) ▾

Step 2 Tap target parameters. On the displayed screen, enter or select relevant information.

NOTE

The plant parameters that are manually entered must not contain any special character, such as "<>:;`~?()#&\\$|%+;~^" in the English half-width status.

----End

6.4.2.3 Setting Revenue Parameters

Procedure

Step 1 Choose **Settings > User param. > Currency** to access the parameter setting screen.

Figure 6-10 Gain



Currency	
Currency	JPY ▾
Currency factor	500.000
CO2 emission reduction coefficient(kg/kWh)	0.997

----End

6.4.3 Maintenance

6.4.3.1 System Maintenance

Context

A common user can choose **Maintenance** to change only the SmartLogger password.

Procedure

Step 1 Choose **Maintenance > Change Password** to access the password change screen.

Figure 6-11 Changing a password



Step 2 Type the old password, new password, and confirmation password. Tap **Confirm**.

NOTE

The password must meet the following requirements:

- Contains 6–20 characters.
- Contains at least two of the three types: lowercase letters, uppercase letters, and digits.

----End

6.4.3.2 Feedback

Context

Users can provide feedback in text, pictures, and files.

NOTE

Do not add private data.

Procedure

Step 1 Choose  > **Feedback** in the upper-right corner of the home screen.

Figure 6-12 Feedback



Step 2 Tap **Specify the type** and select **Feedback** or **Suggestion**.

Figure 6-13 Problem record

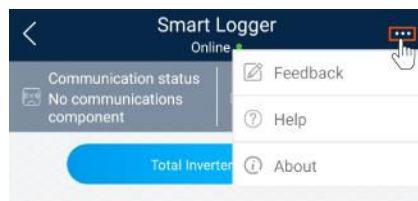
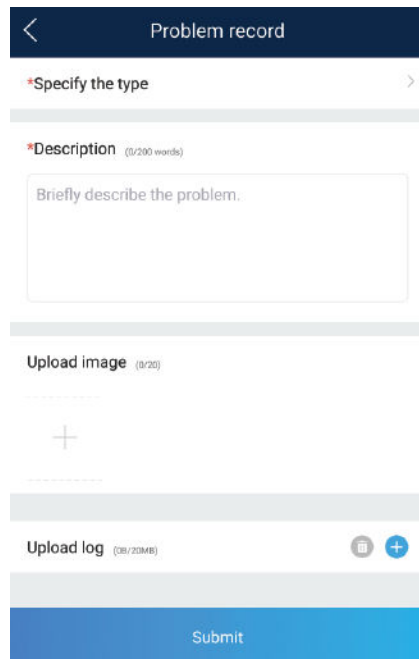

Step 3 Briefly describe the problem that you encounter in the **Description** column.

Step 4 (Optional) Tap  to upload pictures.

Step 5 (Optional) Tap  to upload logs. Select device logs or app logs as required.

Step 6 Tap **Submit**.

----End

6.4.3.3 Help

Context

If you have any questions when using an involved device or the app, search for solutions in the help information.

Procedure

Step 1 Choose  > **Help** in the upper-right corner of the home screen.

Figure 6-14 Help 1



Step 2 Specify your question. A solution will be displayed.

Figure 6-15 Help 2

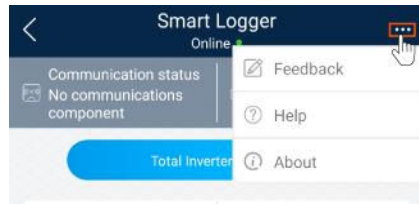
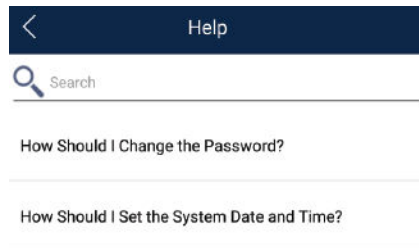

----End

6.4.3.4 About

Context

You can query the app version, connected product model, SN, firmware version, software version, technical support website, privacy policy (displayed only on the SUN2000 app), customer service contact information, and open source software policy.

NOTE

- When the app starts for the first time after being downloaded or updated, the privacy policy is displayed. You can use the app only after agreeing to the privacy policy, and the privacy policy will no longer appear. If you do not agree to the privacy policy, the app exits, and the privacy policy is still displayed when you start the app next time until you agree to the privacy policy.
- You can revoke the agreed privacy policy.

Procedure

Step 1 In the upper-right corner of the home screen, choose  > **About** to view the app version, connected product model, SN, firmware version, software version, and technical support website.

Figure 6-16 About



Step 2 Tap **Privacy policy**, **Customer service contact information**, or **Open source software policy** to view the privacy policy, customer service contact information, and open source software policy.

----End

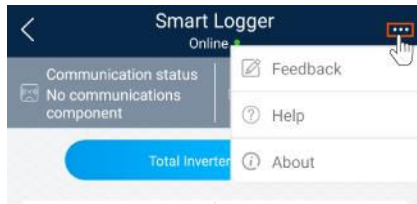
6.4.4 Device Monitoring

6.4.4.1 Query

Step 1 On the home screen, tap **Monitor** to access the device monitoring screen.

Figure 6-17 Device monitoring

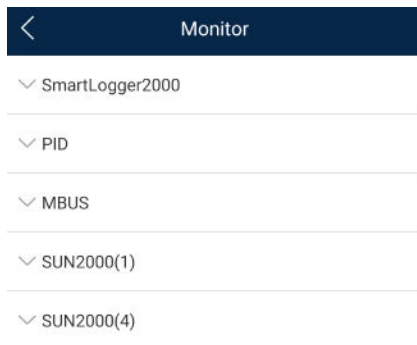

Step 2 Select a target device to access the function menu screen of the device.

Step 3 Tap **Alarm**, **Running Info.**, **Energy Yield**, or **About** to view the alarms, running information, energy yield, and version information about the device.

NOTE

- The displayed information varies according to the device type.
- The SmartLogger can connect to third-party devices that support the Modbus-RTU protocol, such as the box-type transformer and EMI. The SmartLogger cannot automatically search user-defined devices. You need to manually add them.
- The SmartLogger can connect to a maximum of five types of user-defined devices and can connect to multiple devices of the same type.
- The SmartLogger can connect to a third-party device that supports IEC103, such as a relay protection or monitoring device like a box-type transformer. The SmartLogger cannot automatically search IEC103 devices. You need to manually add them.
- The SmartLogger can connect to a maximum of five types of IEC103 devices and can connect to multiple devices of the same type.

----End

6.4.4.2 Maintenance

Context

Common users can maintain only a solar inverter. They manually send commands to start or shut down the solar inverter.

Procedure

- Step 1** Tap **SUN2000** on the **Monitor** screen and select the target device to access the function menu screen of the solar inverter.

Figure 6-18 Maintenance

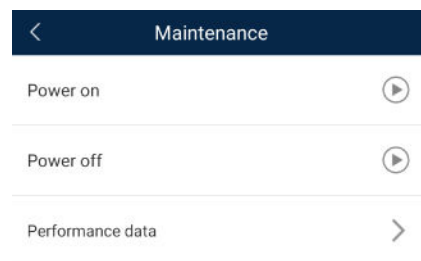

- Step 2** Tap **Maintenance**.

- Step 3** Tap  next to **Power on** or **Power off** to perform the operation.

 **NOTE**

Tap **Performance Data** to view the performance data curve of the solar inverter.

- Step 4** Enter the password for logging in to the app, and tap **Confirm**.

----End

6.5 Screen Operations (Advanced User)

6.5.1 Query

Procedure

- Step 1** After logging in to the app, you can view the active power and energy yield of the connected solar inverters on the home screen.

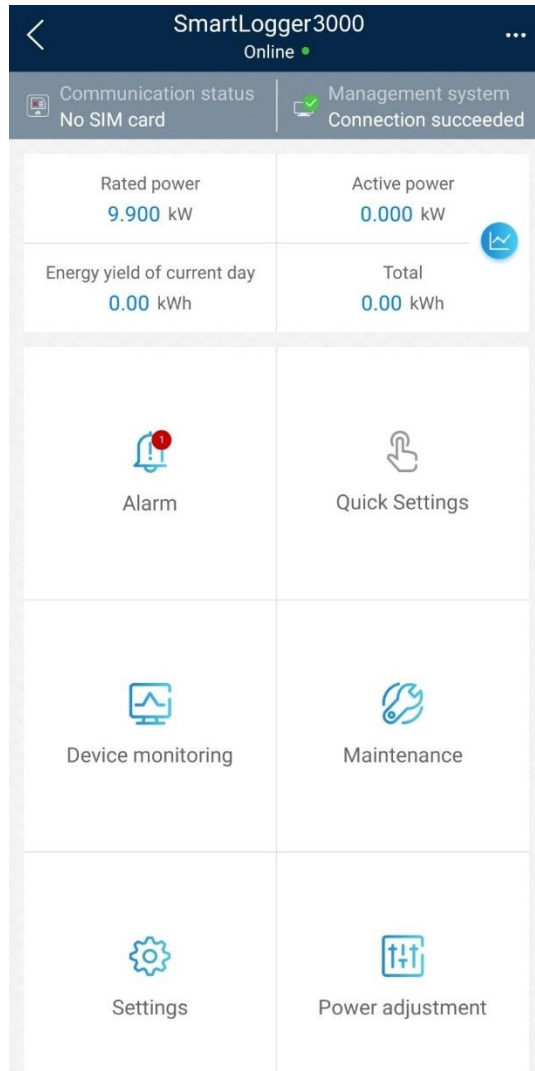

Step 2 Tap **Alarm management** or **Device Monitoring** to view active alarms, historical alarms, and running information.

You can view the following information on the alarm management screen:

- Tap an alarm record and view the alarm details.
- Swipe right or left on the screen or tap either **Active Alarm** or **Historical Alarm** to display a list of active alarms or historical alarms.
- Select the alarms that can be manually cleared, and tap **Delete** on the right of the alarm to manually clear the alarms.

----End

6.5.2 Device Monitoring

An advanced user can tap **Device Monitor** to query the running information and alarms about the SmartLogger and the devices connected to it, set parameters, and send commands.

6.5.2.1 Query

Step 1 On the home screen, tap **Device Monitor** to access the device monitoring screen.

Figure 6-19 Device monitoring

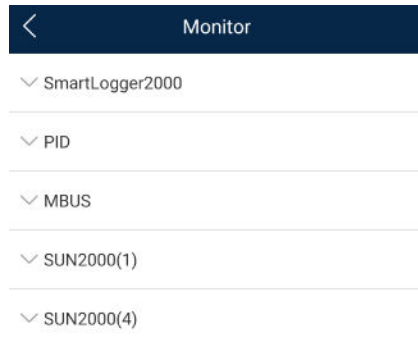

Step 2 Select a target device to access the function menu screen of the device.

Step 3 Tap **Alarm**, **Running Info.**, **Energy Yield**, or **About** to view the alarms, running information, energy yield, and version information about the device.

 **NOTE**

- The displayed information varies according to the device type.
- The SmartLogger can connect to third-party devices that support the Modbus-RTU protocol, such as the box-type transformer and EMI. The SmartLogger cannot automatically search user-defined devices. You need to manually add them.
- The SmartLogger can connect to a maximum of five types of user-defined devices and can connect to multiple devices of the same type.
- The SmartLogger can connect to a third-party device that supports IEC103, such as a relay protection or monitoring device like a box-type transformer. The SmartLogger cannot automatically search IEC103 devices. You need to manually add them.
- The SmartLogger can connect to a maximum of five types of IEC103 devices and can connect to multiple devices of the same type.

----End

6.5.2.2 Settings

Context

An advanced user can set solar inverter parameters, MBUS parameters, PID Module parameters and DL/T645 parameters.

Procedure

Step 1 On the **Device Monitor** screen, select the target device to access the function menu screen of the solar inverter.

Step 2 Tap **Settings** to access the settings screen.

Step 3 Set parameters as required.

 **NOTE**

For Setting MBUS Parameters, set **Anti-crosstalk** to **Enable** to make devices in the anti-crosstalk list take effect.

----End

6.5.2.3 Maintenance

6.5.2.3.1 Log Download

Context

An advanced user can download only the logs of the SmartLogger, solar inverter, MBUS, and PID module.

Procedure

- Step 1** Select a device on the **Device Monitor** screen to access the function menu screen of the device.
- Step 2** Tap **Device Logs** to access the log download screen.
- Step 3** Download log files as required.

NOTE

- By default, Android system logs are saved in the **Android/data/com.huawei.inverterapp/files/inverterapp** folder in the phone memory. You can change the save path by referring to "Setting a File Save Path".
- The downloaded solar inverter logs are saved at the **Device Log** directory in **File Manager** in your mobile phone. You can also send the logs to your mailbox for checking.

----End

6.5.2.3.2 Solar Inverter Maintenance

Procedure

- Step 1** Tap **SUN2000** on the **Device Monitor** screen and select the target device to access the function menu screen of the solar inverter.
- Step 2** Tap **Maintenance** to access the maintenance screen.
- Step 3** Tap  next to **Power on**, **Power off**, **AFCI self-check**, or **Reset**.

NOTE



- AFCI self-check is available only for the solar inverter model marked with **-US**.
- Tap **License Management** or **Performance Data** to view the certificate information and performance data curve of the solar inverter.

- Step 4** Enter the password for logging in to the app, and tap **Confirm**.

----End



6.5.2.3.3 MBUS Maintenance

Procedure

- Step 1** Tap **MBUS** on the **Device Monitor** screen and select the target device to access the function menu screen of the MBUS.
- Step 2** Tap **Maintenance** to access the maintenance screen.
- Step 3** Tap  next to **Search STA Again** and search for the STA list again as prompted.
- Step 4** Tap  next to **MBUS reset** and reset the MBUS as prompted.
- Step 5** Tap **Anti-crosstalk list** to synchronize, import, or export the list.
- End

6.5.2.3.4 PID Module Maintenance

Procedure

- Step 1** Tap **PID** on the **Device Monitor** screen and select the target device to access the function menu screen of the PID module.
- Step 2** Tap **Maintenance** to access the maintenance screen.
- Step 3** Tap  next to **Power on**, **Power off**, or **Data clear** as required.
-  **NOTE**
- If you clear data, active and historical alarms stored on the PID module will all be cleared.
 - Tap **Performance Data** to view the performance data curve of the PID module.
- Step 4** Enter the password for logging in to the app, and tap **Confirm**.
- End

6.5.3 Maintenance

6.5.3.1 System Maintenance

6.5.3.1.1 Changing a User Password

Procedure

- Step 1** Choose **Maintenance > Change Password** to access the password change screen.

Figure 6-20 System Maintenance

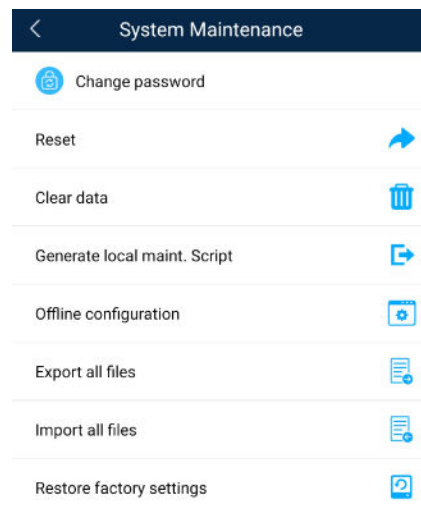

NOTE

The password must meet the following requirements:

- Contains 6–20 characters.
- Contains at least two of the following types: lowercase letters, uppercase letters, and digits.

----End

6.5.3.1.2 Generating the Local Maintenance Script

Prerequisites

A USB flash drive has been inserted into the USB port on the SmartLogger2000.

Context

Only the SmartLogger2000 can generating the local maintenance script to set SmartLogger2000 commands and save the script file in the USB flash drive. The SmartLogger2000 executes the local script file in the USB flash drive to export SmartLogger logs, export or import all files, upgrade application software, and upgrade BSP.

Procedure

- Step 1** Choose **Maintenance > Generate local maint. Script** to access the screen for generating the script.

Figure 6-21 System Maintenance

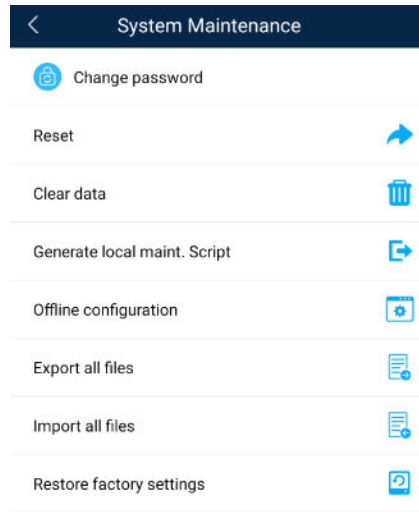

Step 2 Select operations as required and tap **Generate local maint. Script** to save the generated local maintenance script file in the USB flash drive.

----End

Follow-up Procedure

You can also set SmartLogger commands without logging in to the app. For details, see [8.3.2 SmartLogger Maintenance Script](#).

6.5.3.1.3 Offline Configuration

You can import the offline configuration files to the SmartLogger over the app.

Step 1 Choose **Maintenance > Offline configuration** to perform offline configuration.

Figure 6-22 System Maintenance

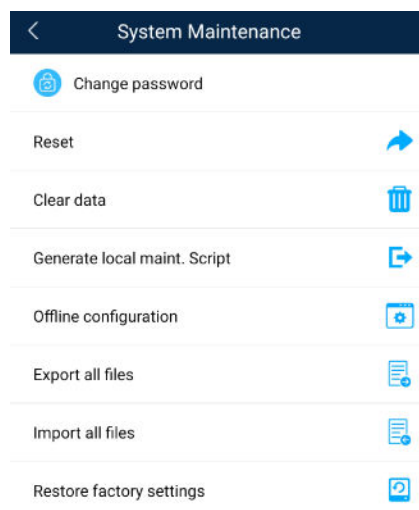

----End

 **NOTE**

After the configuration file is imported, choose **Latest Status** to view the import status of the last offline configuration file and choose **Enable offline config** to import other offline configuration files.

6.5.3.1.4 Resetting the System

Context

After the system resets, the SmartLogger restarts.

Procedure

Step 1 Choose **Maintenance > Reset**. A dialog box for resetting the system is displayed.

Figure 6-23 System Maintenance

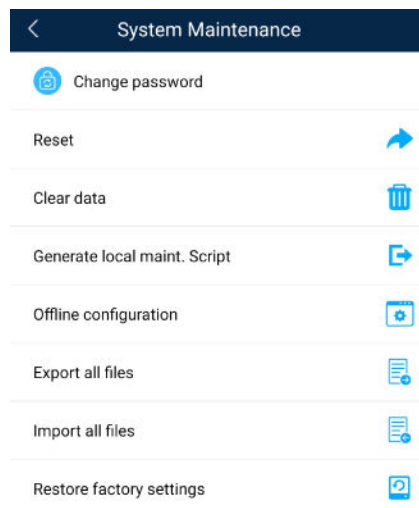

Step 2 Enter the password for logging in to the app, and tap **Confirm**.

----End

6.5.3.1.5 Clearing Data

Context

Clear data if the SmartLogger is relocated and its historical data needs to be deleted.

NOTICE

- After you perform **Clear Data**, electric energy yield data, performance data, and alarms are cleared from the SmartLogger.
- After you perform **Clear Data**, the devices connected to the SmartLogger are not removed. If the original device will no longer connect to the SmartLogger, remove the device.
- If you perform **Clear Data** on the SmartLogger, you also have to perform **Reset Alarms** on the NMS. Otherwise, the alarm information collected by the NMS and SmartLogger will be different.

Procedure

Step 1 Choose **Maintenance > Clear Data**. A dialog box for clearing data is displayed.

Figure 6-24 System Maintenance

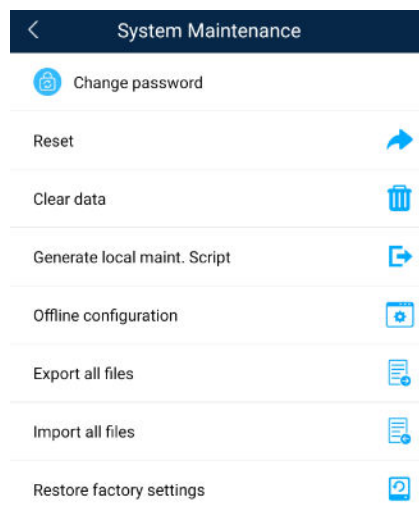

Step 2 Enter the password for logging in to the app, and tap **Confirm**.

----End

6.5.3.1.6 Importing and Exporting All Files

If the SmartLogger needs to be replaced, you can export the files before the replacement and then import the files of the new SmartLogger to ensure data integrity.

Procedure

Step 1 Choose **Maintenance > Import all files (or Export all files)** to import or export all files.

Figure 6-25 System Maintenance

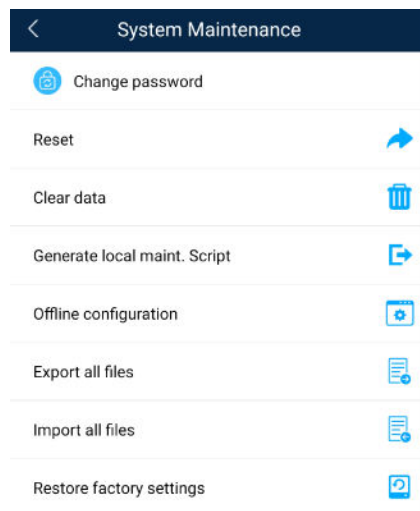

----End

6.5.3.1.7 Restoring Factory Settings

Context

NOTICE

Perform this operation with caution because all configured parameters except the current date, time, baud rate, and address will be restored to their factory default values. This operation will not affect operating information, alarm records, or system logs.

Procedure

- Step 1** Choose **Maintenance > Restore factory settings**. The **Restore factory** dialog box is displayed.

Figure 6-26 System Maintenance

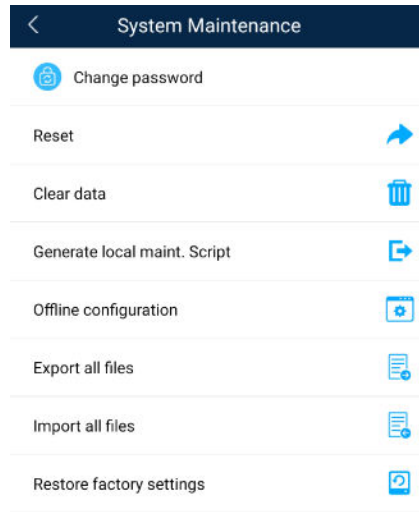

Step 2 Enter the password for logging in to the app, and tap **Confirm**.

----End

6.5.3.2 Solar Inverter Inspection

Context

After a solar inverter is put into use, it should be inspected periodically to detect any potential risks and problems.

Procedure

Step 1 Tap **Maintenance** > **Inverter Inspect** to access the inspection screen.

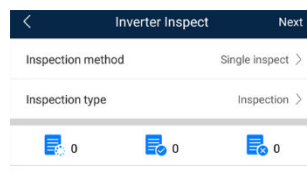

Step 2 Select **Single inspect** or **Batch inspect**.

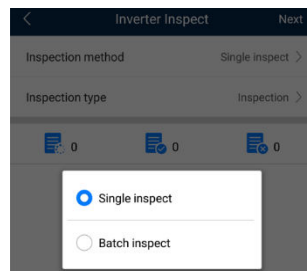

Step 3 Select **Inspection type** and tap **Next** in the upper-right corner of the screen to start inspection.

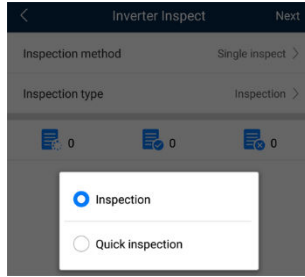

Step 4 An inspection file is generated after the inspection is complete.

NOTE

By default, the inspection file is saved in **Android/data/com.huawei.inverterapp/files/inverterapp** in the phone memory. You can change the log save path by referring to *Setting a File Save Path*.

----End

6.5.3.3 Device Management

6.5.3.3.1 Changing a Device Name

Procedure

Step 1 Choose **Maintenance > Device Mgmt.** to access the **Device Mgmt.** screen.

Step 2 Tap a device name to change it.

Figure 6-27 Changing a device name



NOTE

The name of the SmartLogger cannot be changed.

----End

6.5.3.3.2 Deleting Devices

Procedure

- Step 1** Choose **Maintenance > Device Mgmt.** to access the **Device Mgmt.** screen.
- Step 2** Hold down a device name, select the devices to be deleted, and tap **Batch delete** to delete them.

Figure 6-28 Deleting devices

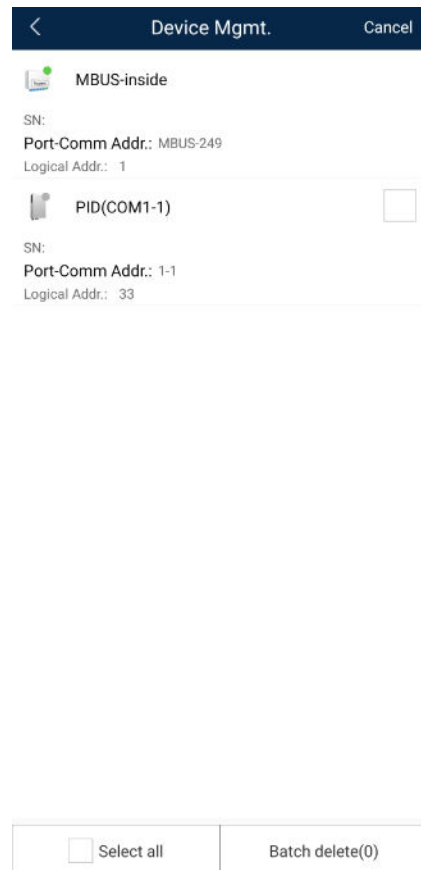

NOTE

Deleted devices are not displayed on the **Monitor** screen.

----End

6.5.3.3.3 Automatically Searching for Devices

Context

The SmartLogger can automatically detect and connect to devices.

The EMI, power meter, slave SmartLogger, and third-party devices cannot be automatically detected. You need to add them manually. For details, see [6.5.3.3.4 Manually Adding a Device](#).

Procedure

Step 1 Choose **Maintenance > Device Mgmt.** to access the **Device Mgmt.** screen.

Figure 6-29 Device management

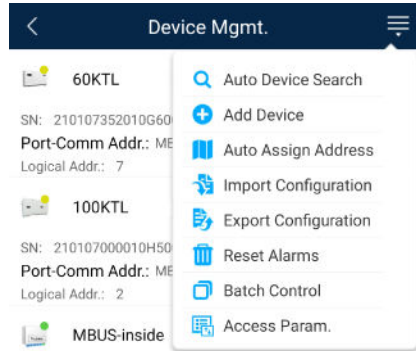

Step 2 Tap the drop-down list in the upper-right corner of the **Device Mgmt.** screen.

Step 3 Automatically searching for devices

----End

6.5.3.3.4 Manually Adding a Device

Context

The EMI, power meter, slave SmartLogger, and third-party devices cannot be automatically detected. You need to add them manually.

Procedure

Step 1 Choose **Maintenance > Device Mgmt.** to access the **Device Mgmt.** screen.

Figure 6-30 Device management

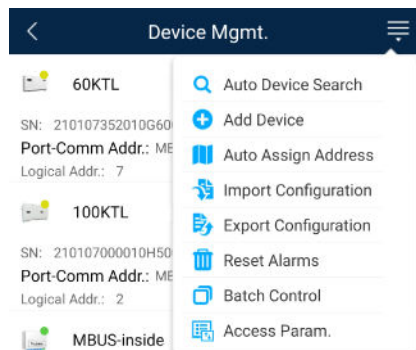

Step 2 Tap the drop-down list in the upper-right corner of the **Device Mgmt.** screen.

Step 3 Tap **Add Device** and set device parameters.

NOTE

- **Comm. Protocol** is set to **Modbus RTU** by default. If you need to modify it, refer to [6.5.4.5 Setting RS485 Parameters](#).
- Before adding the EMI or power meter manually, set the EMI or power meter parameters. For details, see *SmartLogger3000 User Manual* , *SmartLogger2000 User Manual* or *SmartLogger1000A User Manual*.

----End

6.5.3.3.5 Automatically Allocating Addresses

Context

The SmartLogger can automatically allocate addresses to the connected devices and adjust the addresses based on device sequence numbers.

Procedure

Step 1 Choose **Maintenance > Device Mgmt.** to access the **Device Mgmt.** screen.

Figure 6-31 Device management

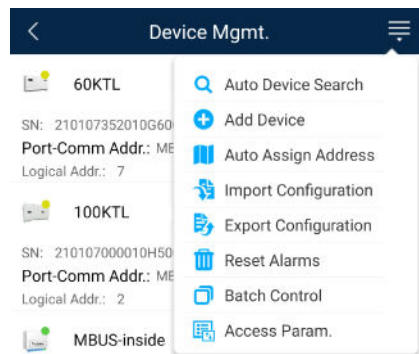

Step 2 Tap the drop-down list in the upper-right corner of the **Device Mgmt.** screen.

Step 3 Tap **Auto Assign Address**.

----End

6.5.3.3.6 Importing Configuration

Prerequisites

The name extension of the file to be imported must be **.cfg**. Otherwise, the file will be unavailable.

- The file to be imported is stored in the memory or SD card of the mobile phone.

Context

When connecting to a user-defined device or the IEC103 device, import a configuration file and add a device manually. Then, the device can be queried on the **Monitor** screen.

Procedure

Step 1 Choose **Maintenance > Device Mgmt.** to access the **Device Mgmt.** screen.

Figure 6-32 Device management

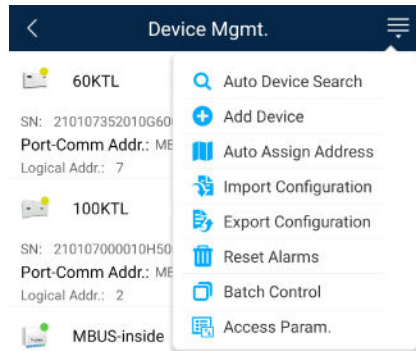

Step 2 Tap the drop-down list in the upper-right corner of the **Device Mgmt.** screen.

Step 3 Tap **Import Config** to import the **.cfg** file.

----End

6.5.3.3.7 Exporting Configuration

Context

After connecting to a third-party device, you can choose **Export Config** to view its configuration file.

Procedure

Step 1 Choose **Maintenance > Device Mgmt.** to access the **Device Mgmt.** screen.

Figure 6-33 Device management

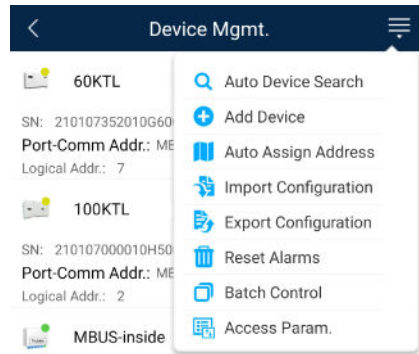

Step 2 Tap the drop-down list in the upper-right corner of the **Device Mgmt.** screen.

Step 3 Tap **Export Config.**

----End

6.5.3.3.8 Resetting Alarms

Context

- If you reset alarms, all the active and historical alarms of the selected device are deleted and the SmartLogger starts to collect new alarm data.
- If data is deleted for a solar inverter, you must reset alarms on the SmartLogger and the NMS; otherwise, the SmartLogger cannot collect new alarm data from the solar inverter.
- If alarms are reset on the SmartLogger, you must reset alarms on the NMS; otherwise, the NMS cannot obtain the new alarm data collected by the SmartLogger from the solar inverter.

Procedure

Step 1 Choose **Maintenance > Device Mgmt.** to access the **Device Mgmt.** screen.

Figure 6-34 Device management

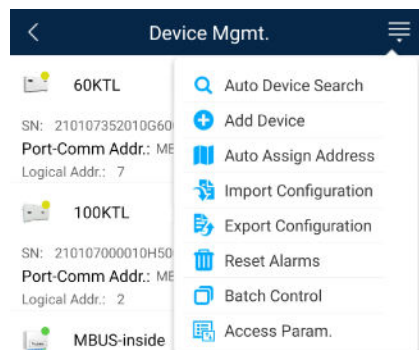

Step 2 Tap the drop-down list in the upper-right corner of the **Device Mgmt.** screen.

Step 3 Tap **Reset Alarms** and select a device on the **Reset Alarms** screen.

Step 4 Tap **Confirm**.

----End

6.5.3.3.9 Starting, Shutting down, and Resetting Solar Inverters in Batches

Context

Batch control operations allow the SmartLogger to start, shut down, and reset the connected solar inverters in batches. The solar inverters automatically restart after reset.

Procedure

Step 1 Choose **Maintenance > Device Mgmt.** to access the **Device Mgmt.** screen.

Figure 6-35 Device management

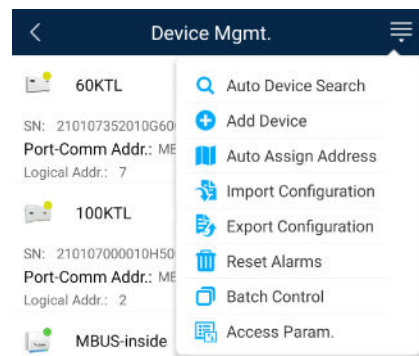

Step 2 Tap the drop-down list in the upper-right corner of the **Device Mgmt.** screen.

Step 3 Tap **Batch Control**.

Step 4 Tap **Batch startup**, **Batch shutdown**, or **Batch reset**, enter the app login password, and tap **Confirm**.

----End

6.5.3.3.10 Setting Access Parameter

Context

Before connecting a device to the SmartLogger, configure access parameters correctly.

Procedure

Step 1 Choose **Maintenance > Device Mgmt.** to access the **Device Mgmt.** screen.

Figure 6-36 Device management

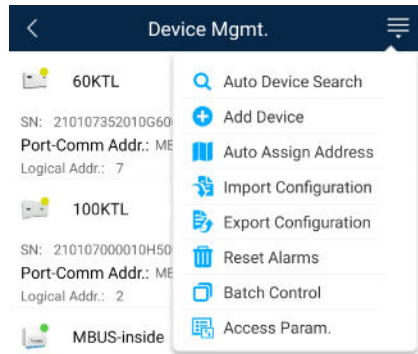

Step 2 Tap the drop-down list in the upper-right corner of the **Device Mgmt.** screen.

Step 3 Tap **Access Param.** to access the settings screen.

NOTE

If the SmartLogger communicates with the solar inverter over the MBUS, set **Embedded MBUS enable** to **Enable**.

----End

6.5.3.4 Managing the Device List

Context

On the device list screen, you can choose **Export Device Info > Edit Device Info File > Import Device Info** to modify device information in the information file.

Procedure

Step 1 Choose **Maintenance > Device List** to access the device list screen.

Figure 6-37 Device List

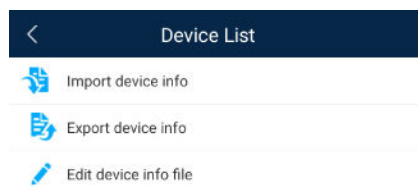

Step 2 Tap **Export Device Info** to export the device information file.

NOTE

The exported device information file is in .csv format.

Step 3 Tap **Edit Device Info File** to modify the device information file.

1. In the path where the device information file is exported, tap the exported .csv file to access the screen for modifying the file.
2. Tap a parameter to be modified and enter or select target information.
3. After all modifications, tap **Save** in the upper-right corner of the screen.

Step 4 Tap **Import Device Info** to import the modified device information file to the SmartLogger.

----End

6.5.3.5 Exporting Device Logs

Prerequisites

A USB flash drive has been inserted into the USB port on the SmartLogger.

Procedure

Step 1 Choose **Maintenance > Device logs** to access the device log screen.

Step 2 Tap  in the upper-right corner of the screen, select a device whose logs are to be exported, and tap **Next**.

Figure 6-38 Exporting device logs



Step 3 Select the types of logs to be exported and tap **Confirm** to start exporting device logs.

 **NOTE**

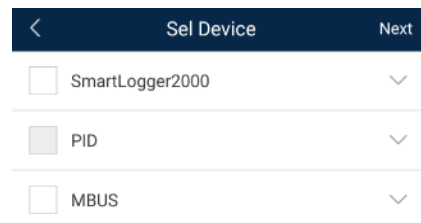
The downloaded device logs are saved at the storage path of the USB flash drive.

----End

6.5.3.6 Device Upgrade

Prerequisites

- You have obtained the upgrade package with the help of the supplier or Huawei engineers. After the downloading is complete, use the digital certificate and verification tool available at Huawei technical support website to verify the digital signature of the software package.
 - a. Log in to Huawei enterprise technical support website <http://support.huawei.com/enterprise>.
 - b. Browse or search for **PGP Verify**.

- Insert the USB flash drive where the upgrade package is saved into the USB port on the SmartLogger.

Procedure

Step 1 Choose **Maintenance > Upgrade** to access the device upgrade screen.

Figure 6-39 Device upgrade

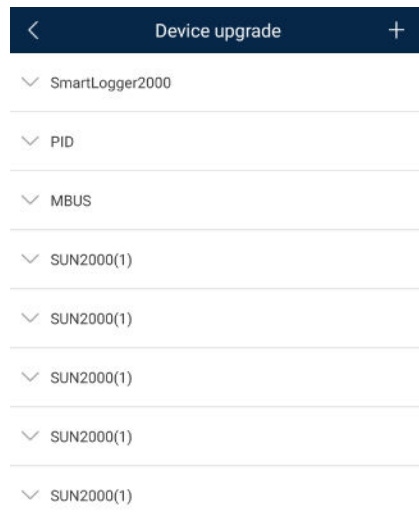

Step 2 Tap  in the upper-right corner, select a single device or devices of the same type, and tap **Next**.

Step 3 Select the upgrade package and tap **Next**.

Step 4 Confirm the upgrade package and the device to be upgraded, and tap **Finish** to start upgrading the device.

----End

6.5.3.7 Spot-Checking Solar Inverters

Context

You can perform spot-check for the solar inverter whose **Grid Code** is **Japan standard**.

Procedure

Step 1 Choose **Maintenance > Inverter Spot** to access the solar inverter spot-check screen.

Figure 6-40 Inverter spot

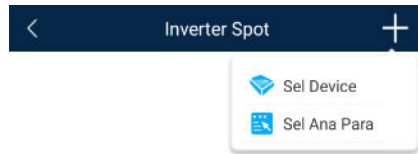

Step 2 (Optional) Tap  in the upper-right corner of the **Inverter Spot** screen, select **Sel Ana Para**, and tap **Finish** to set analog parameters.

 **NOTE**

After the parameters on the **Sel Analog Para** screen are set, the analog parameters and their values are displayed on the solar inverter spot-check screen. You can also tap **Sel Device** to set parameters when the solar inverters are being spot-checked.

Step 3 Tap  in the upper-right corner of the **Inverter Spot** screen and select **Sel Device** to access the **Sel Device** screen.

Step 4 Select one or more devices to be spot-checked, and then tap **Finish** to start spot-check.

----End

6.5.3.8 Feedback

Context

Users can provide feedback in text, pictures, and files.

 **NOTE**

Do not add private data.

Procedure

Step 1 Choose  > **Feedback** in the upper-right corner of the home screen.

Figure 6-41 Feedback



Step 2 Tap **Specify the type** and select **Feedback** or **Suggestion**.

Figure 6-42 Problem record

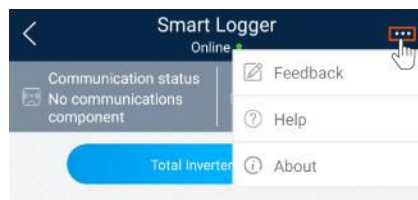
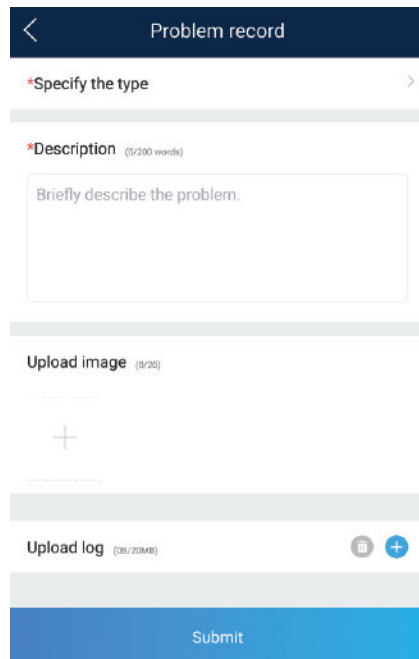

Step 3 Briefly describe the problem that you encounter in the **Description** column.

Step 4 (Optional) Tap  to upload pictures.

Step 5 (Optional) Tap  to upload logs. Select device logs or app logs as required.

Step 6 Tap **Submit**.

----End

6.5.3.9 Help

Context

If you have any questions when using an involved device or the app, search for solutions in the help information.

Procedure

Step 1 Choose  > **Help** in the upper-right corner of the home screen.

Figure 6-43 Help 1



Step 2 Specify your question. A solution will be displayed.

Figure 6-44 Help 2

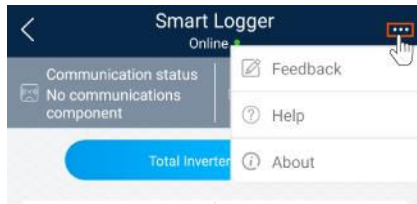
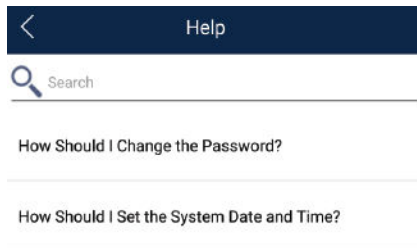

----End

6.5.3.10 About

Context

You can query the app version, connected product model, SN, firmware version, software ver., technical support website, privacy policy (displayed only on the SUN2000 app), customer service contact information, and open source software policy.

NOTE

- When the app starts for the first time after being downloaded or updated, the privacy policy is displayed. You can use the app only after agreeing to the privacy policy, and the privacy policy will no longer appear. If you do not agree to the privacy policy, the app exits, and the privacy policy is still displayed when you start the app next time until you agree to the privacy policy.
- You can revoke the agreed privacy policy.

Procedure

Step 1 In the upper-right corner of the home screen, choose  > **About** to view the app version, connected product model, SN, firmware version, software version, and technical support website.

Figure 6-45 About



Step 2 Tap **Privacy policy**, **Customer service contact information**, or **Open source software policy** to view the privacy policy, customer service contact information, and open source software policy.

----End

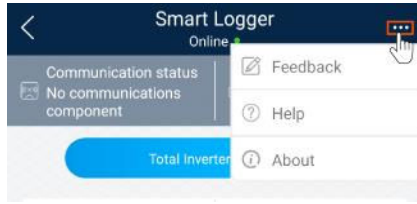
6.5.4 Settings

An advanced user can choose **Settings** to access the settings screen and set the user parameters, communications parameters, extended parameters, and file save path for the SmartLogger.

Figure 6-46 Settings (advanced user)

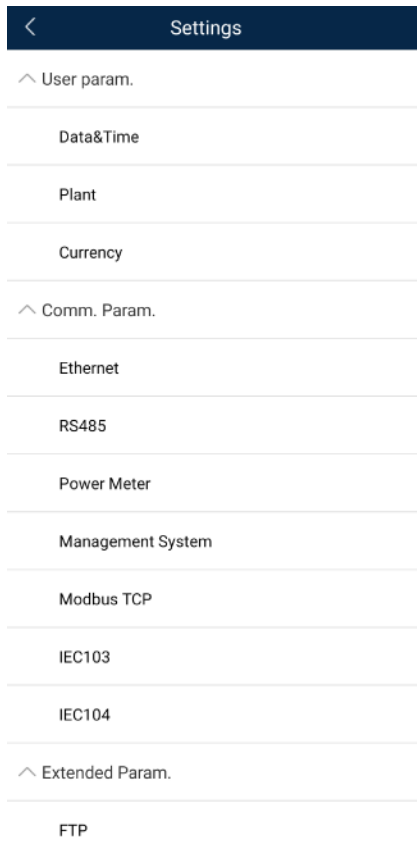

 **NOTE**

Only the SmartLogger1000A/SmartLogge3000 supports **Mobile Data (4G/3G/2G)** and **WLAN** settings.

6.5.4.1 Setting the System Date and Time

Procedure

Step 1 Choose **Settings > User param. > Date&Time** to set the date and time.

Figure 6-47 Date&Time screen



Step 2 Set the date and time based on the region where the SmartLogger is located.

 **NOTE**

For a solar inverter that supports DST, if an advanced user enables DST, a common user can view DST data. The displayed parameters are for reference only.

----End

6.5.4.2 Setting Plant Information

Step 1 Choose **Settings > User param. > Plant** to access the parameter setting screen.

Figure 6-48 Plant

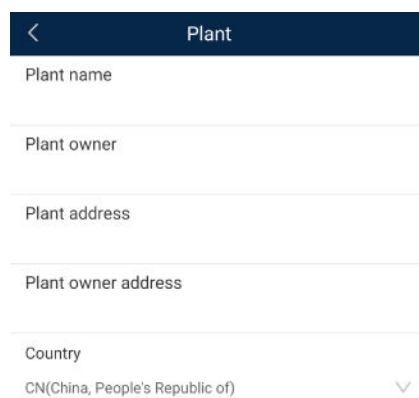

Step 2 Tap target parameters. On the displayed screen, enter or select relevant information.

 **NOTE**

The plant parameters that are manually entered must not contain any special character, such as <>,'?()#&\\$|%+;~^" in the English half-width status.

----End

6.5.4.3 Setting Revenue Parameters

Procedure

Step 1 Choose **Settings** > **User param.** > **Revenue** to access the parameter setting screen.

Figure 6-49 Gain



----End

6.5.4.4 Setting Ethernet Parameters

Context

Set Ethernet parameters to ensure proper operation of Ethernet ports and functions of logging in to the embedded WebUI of the SmartLogger, connecting to the NMS, and sending emails.

Procedure

Step 1 Choose **Settings** > **Comm. Param.** > **Ethernet** to access the Ethernet parameter setting screen.

Step 2 Tap target parameters. On the displayed screen, enter relevant information.

NOTICE

If the SmartLogger connects to the Internet through a router, note the following when setting Ethernet parameters:

- Set the NMS address to the IP address of the router.
 - Ensure that the IP address of the SmartLogger is in the same network segment as the NMS address.
 - Set the domain name server (DNS) address to the IP address of the router or obtain the DNS address from the network provider.
 - After the IP address is changed, you need to use the new IP address to log in to the system.
 - When DHCP is enabled, the IP address cannot be set.
-

----End

6.5.4.5 Setting RS485 Parameters

Context

Set RS485 parameters to ensure normal communication between the SmartLogger and devices such as the SUN2000, EMI, and power meter.

Procedure

Step 1 Choose **Settings > Comm. Param. > RS485** to access the parameter setting screen.

Step 2 Select a port from **COM1** to **COM6**.

Use the settings of **COM1** as an example.

Figure 6-50 COM1

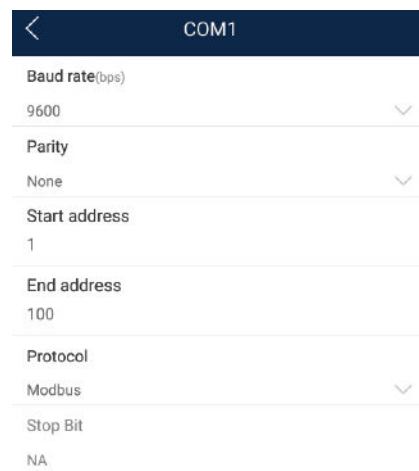

COM1	
Baud rate(bps)	9600
Parity	None
Start address	1
End address	100
Protocol	Modbus
Stop Bit	NA

NOTE

- **COM1** to **COM6** correspond to communications ports **COM1–COM3** (SmartLogger1000A and SmartLogger3000) or **COM1–COM6** (SmartLogger2000). The default baud rate is **9600 bit/s**.
- The SmartLogger3000 expansion module corresponds to communication ports **M1.COM1~M1.COM3**.

- Set the protocol supported by the RS485 port based on either the protocol supported by the connected device or the status of the device in the network. When the SmartLogger serves as a slave node to interconnect with a third-party device over Modbus-RTU, set **Protocol** to **Modbus-Slave**. When the connected solar inverter performs rapid power grid scheduling using both MBUS and RS485, set **Protocol** to **Modbus-Control**.
- **Parity**, **Protocol**, and **Stop bit** must be set to the same values for all devices connected to the same RS485 port.
- The baud rate for the RS485 ports of the SmartLogger must be the same as the baud rate for the device that communicates with the SmartLogger.
- $1 \leq \text{Start address} \leq \text{End address} \leq 247$. The address range of the ports can overlap. Set the address range as required. A larger address range requires a longer searching time. The start and end addresses have no impact on the devices that have been connected.

Step 3 On the **RS485** screen, tap **Night Communication Settings** to set the parameters for communication at night.

----End

6.5.4.6 Setting Modbus-RTU Power Meter Parameters

Procedure

Step 1 Choose **Settings > Comm. Param. > Power Meter** to access the parameter setting screen.

Figure 6-51 Power Meter

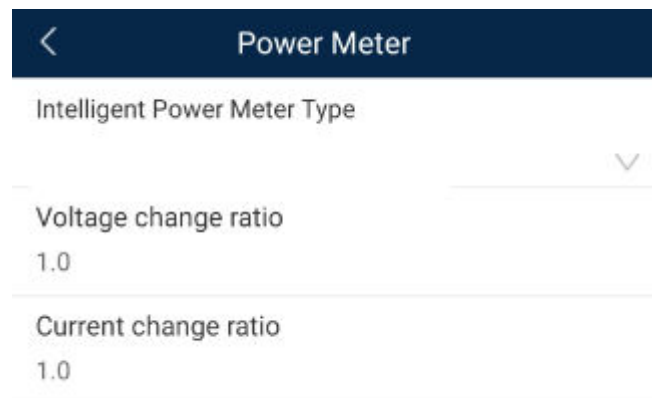

Step 2 Tap target parameters. On the displayed screen, enter relevant information.

----End

6.5.4.7 Setting Management System Parameters

Procedure

Step 1 Choose **Settings > Comm. Param. > Management System** to access the parameter setting screen.

Figure 6-52 Management system

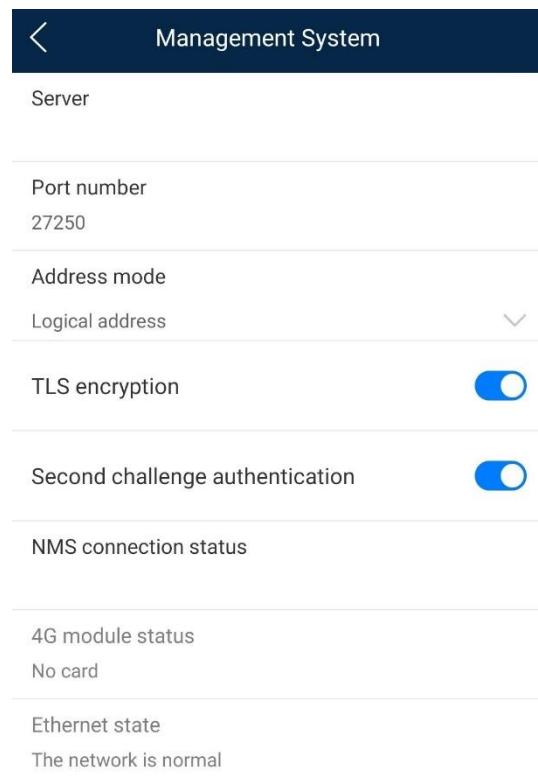

NOTE

- Set **Server** to the IP address or domain name of the NMS server.
- When the SmartLogger connects to the Huawei NMS, retain the default value **27250** for **Port number**. When the SmartLogger connects to a third-party NMS, set **Port number** according to the server port enabled in the third-party NMS.
- In most cases, set **Address mode** to **Physical address**. In this mode, addresses of devices connected to each RS485 port cannot be duplicate. If the devices connected to the six RS485 ports of the SmartLogger have duplicate addresses, set **Address mode** to **Logical address**.
- If **TLS encryption** is set to , data will be transmitted without being encrypted, which may pose security risks. Therefore, exercise caution when setting this parameter.
- If **Secondary challenge authentication** is set to , the result of the second challenge authentication is not checked, which may pose security risks. Therefore, exercise caution when setting this parameter.

----End

6.5.4.8 Setting Modbus TCP Parameters

Context

Set Modbus-TCP parameters correctly to ensure normal communication between the SmartLogger and a third-party NMS.

Procedure

Step 1 Choose **Settings > Comm. Param. > Modbus TCP** to access the parameter setting screen.

Figure 6-53 Modbus TCP

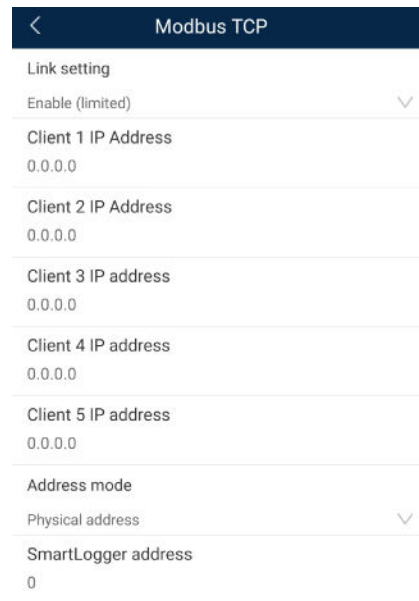

NOTE

- Modbus TCP is a universal standard protocol used to connect to a third-party management system. Because there is no security authentication mechanism, data transmitted by Modbus TCP is not encrypted. To reduce network security risks, the function of connecting to a third-party management system using Modbus TCP is disabled by default. This protocol can transmit the running data and control commands of PV plants, which may cause user data breach and control permission theft. Therefore, exercise caution when using this protocol. Users are liable for any loss caused by the use of this protocol to connect to a third-party management system (non-secure protocol). Users are advised to take measures at the PV plant level to reduce security risks, or use Huawei management system to mitigate the risks.
- If the devices connected to the six RS485 ports of the SmartLogger have duplicate addresses, set **Address mode** to **Logical address**.

----End

6.5.4.9 Setting IEC103 Device Parameters

Procedure

Step 1 Choose **Settings > Comm. Param. > IEC103** to access the parameter setting screen.

Figure 6-54 IEC103



Step 2 Tap target parameters. On the displayed screen, enter relevant information.

----End

6.5.4.10 Setting IEC104 Device Parameters

Procedure

Step 1 Choose **Settings > Comm. Param. > IEC104** to access the parameter setting screen.

Figure 6-55 IEC104



Step 2 Tap target parameters. On the displayed screen, enter relevant information.

NOTE

- IEC104 is a universal standard protocol used to connect to a third-party management system. Because there is no security authentication mechanism, data transmitted by IEC104 is not encrypted. To reduce network security risks, the function of connecting to a third-party management system using IEC104 is disabled by default. This protocol can transmit the running data and control commands of PV plants, which may cause user data breach and control permission theft. Therefore, exercise caution when using this protocol. Users are liable for any loss caused by the use of this protocol to connect to a third-party management system (non-secure protocol). Users are advised to take measures at the PV plant level to reduce security risks, or use Huawei management system to mitigate the risks.
- You can set the IP whitelist after **Linking setting** on the **Basic parameters** screen is enabled.
- On the **Transfer table config** screen, you can set teleindication and telemetry signals for devices.

----End

6.5.4.11 Remotely Shutting Down Solar Inverters in Dry Contact Mode

Procedure

Step 1 Choose **Settings** > **Extended Param.** > **Dry contact remote shutdown**. On the displayed screen, set parameters to remotely shut down solar inverters in dry contact mode.

Figure 6-56 Remotely shutting down solar inverters in dry contact mode

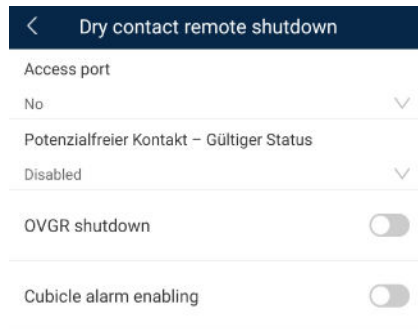

----End

6.5.4.12 Setting FTP Parameters

Context

The FTP function is used to access a third-party NMS. The SmartLogger can report the configuration information and running data of the managed plant system through FTP. The third-party NMS can access Huawei devices with proper configurations.

NOTE

FTP is a universal standard protocol without any security authentication mechanism. Data transmitted by FTP is not encrypted. To reduce network security risks, the IP address of the connected third-party FTP server is left blank by default. This protocol can transmit the running data of PV plants, which may cause user data breach. Therefore, exercise caution when using this protocol. Users are liable for any loss caused by the enabling of the FTP protocol (non-secure protocol). Users are advised to take measures at the PV plant level to reduce security risks, or use Huawei management system to mitigate the risks

Procedure

Step 1 Choose **Settings** > **Extended Param.** > **FTP** to access the parameter setting screen.

Figure 6-57 FTP

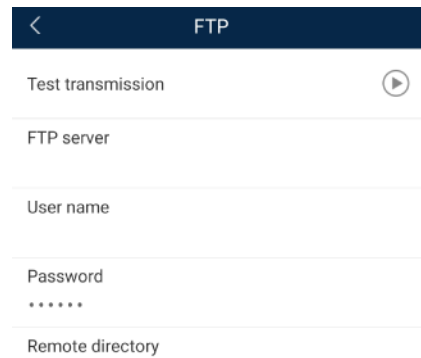

NOTE

- Perform **Test transmission** to check whether the SmartLogger can report data to the FTP server.
- Set **FTP server** to the domain name or IP address of the FTP server. If **FTP server** is set to the domain name of the FTP server, ensure that the address of the DNS server is set correctly.
- Set **User name** and **Password** for logging in to the FTP server.
- Set **Remote directory** to create a subdirectory of the same name under the default path for uploading data.
- If **Data export** is enabled, you can set the SmartLogger to report data regularly or at a specified time. Data reported at a specified time is all data, whose file name remains the same for a whole day. You can choose all data or incremental data to be reported regularly.

----End

6.5.4.13 Setting Email Parameters

Context

The SmartLogger can send emails to inform users of the current energy yield information, alarm information, and device status of the power plant system, helping users know the running status of the power plant system in time.

When using this function, ensure that the SmartLogger can connect to the configured email server and the Ethernet parameters and email parameters are correctly set for the SmartLogger.

Procedure

Step 1 Choose **Settings > Extended Param. > Email** to access the parameter setting screen.

Figure 6-58 Email

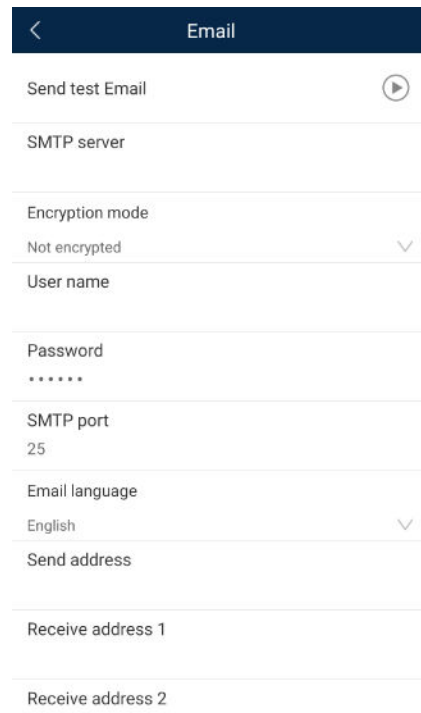

NOTE

- You can tap **Send test email** to check whether the SmartLogger can successfully send emails to users.
- You can set **SMTP server** to the domain name or IP address of the SMTP server. If it is set to the domain name of the SMTP server, ensure that the address of the DNS server is set correctly.
- Set **User name** and **Password** for logging in to the SMTP server.
- **Send address** indicates the sender's email address. Ensure that the sender's email server is the same as the server specified by **SMTP server**.

----End

6.5.4.14 Setting a File Save Path

Prerequisites

This function is available only on the Android system.

Context

You can modify the save path for logs of devices connected to the SmartLogger and export logs from the path.

Procedure

- Step 1** Choose **Settings > Path Settings > File save path** to access the screen for setting a file save path.

Figure 6-59 Setting a file save path

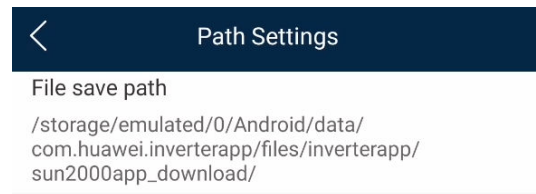

Step 2 Tap **File save path** to set a file save path.

----End

6.5.5 Power adjustment

6.5.5.1 Active Power Control

Procedure

Step 1 Choose **Power adjustment > Active Power Control** to access the **Active Power Control** screen.

Step 2 Tap **Active power control mode** to set the active power control mode.

Figure 6-60 Active power control



----End

6.5.5.2 Setting Reactive Power Control

Procedure

Step 1 On the home screen, tap **Power adjustment > Reactive Power control** to access the parameter setting screen.

Step 2 Tap **Reactive power control mode** to set the active power control mode.

----End

6.6 Screen Operations (Special User)

6.6.1 Query

Procedure

Step 1 After logging in to the app, you can view the active power and energy yield of the connected solar inverters on the home screen.

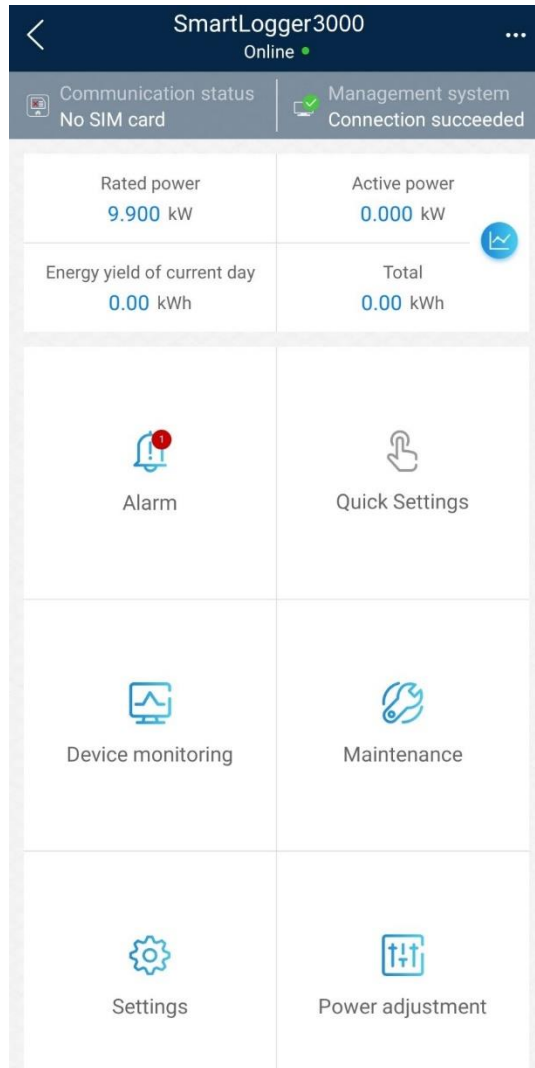

Step 2 Tap **Alarm management** or **Device Monitoring** to view active alarms, historical alarms, and running information.

You can view the following information on the alarm management screen:

- Tap an alarm record and view the alarm details.
- Swipe right or left on the screen or tap either **Active Alarm** or **Historical Alarm** to display a list of active alarms or historical alarms.
- Select the alarms that can be manually cleared, and tap **Delete** on the right of the alarm to manually clear the alarms.

----End

6.6.2 Settings

6.6.2.1 Setting RS485 Parameters

Context

Set RS485 parameters to ensure normal communication between the SmartLogger and devices such as the SUN2000, EMI, and power meter.

Procedure

Step 1 Choose **Settings** > **RS485** to access the parameter setting screen.

Step 2 Select a port from **COM1** to **COM6**.

Use the settings of **COM1** as an example.

Figure 6-61 COM1

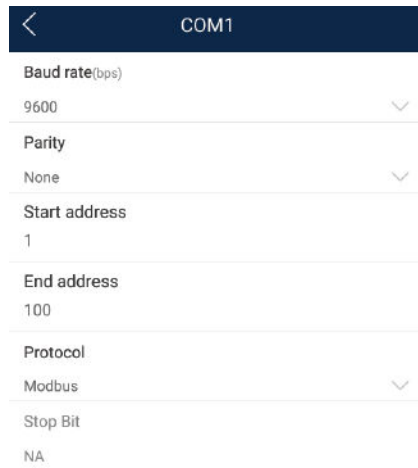

NOTE

- **COM1** to **COM6** correspond to communications ports **COM1–COM3** (SmartLogger1000A and SmartLogger3000) or **COM1–COM6** (SmartLogger2000). The default baud rate is 9600 bit/s.
- Set the protocol supported by the RS485 port based on either the protocol supported by the connected device or the status of the device in the network. When the SmartLogger serves as a slave node to interconnect with a third-party device over Modbus-RTU, set **Protocol** to **Modbus-Slave**. When the connected solar inverter performs rapid power grid scheduling using both MBUS and RS485, set **Protocol** to **Modbus-Control**.
- **Parity**, **Protocol**, and **Stop bit** must be set to the same values for all devices connected to the same RS485 port.
- The baud rate for the RS485 ports of the SmartLogger must be the same as the baud rate for the device that communicates with the SmartLogger.
- $1 \leq \text{Start address} \leq \text{End address} \leq 247$. The address range of the ports can overlap. Set the address range as required. A larger address range requires a longer searching time. The start and end addresses have no impact on the devices that have been connected.

Step 3 On the **RS485** screen, tap **Night Communication Settings** to set the parameters for communication at night.

----End

6.6.2.2 Setting Modbus-RTU Power Meter Parameters

Procedure

Step 1 Choose **Settings > Power Meter** to access the parameter setting screen.

Figure 6-62 Power Meter

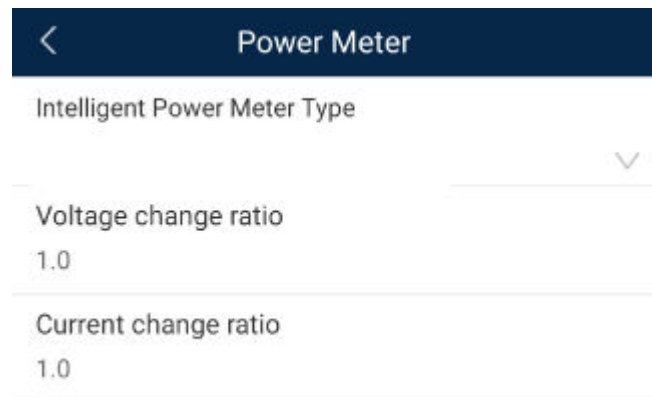

Step 2 Tap target parameters. On the displayed screen, enter relevant information.

----End

6.6.3 Maintenance

6.6.3.1 Solar Inverter Inspection

Context

After a solar inverter is put into use, it should be inspected periodically to detect any potential risks and problems.

Procedure

Step 1 Tap **More > Inverter Inspect** to access the inspection screen.

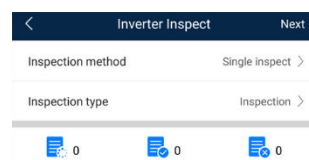

Step 2 Select **Single inspect** or **Batch inspect**.

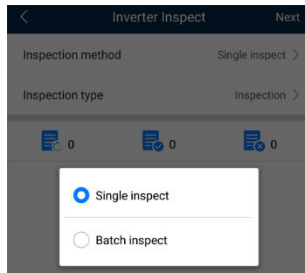

Step 3 Select **Inspection type** and tap **Next** in the upper-right corner of the screen to start inspection.

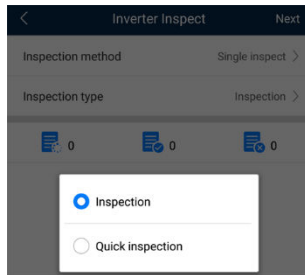

Step 4 An inspection file is generated after the inspection is complete.

NOTE

By default, the inspection file is saved in **Android/data/com.huawei.smartpvms/files/inverterapp** in the phone memory. You can change the log save path by referring to *Setting a File Save Path*.

----End

6.6.3.2 System Maintenance

You can choose **Maintenance** to change the SmartLogger password and reset the system.

6.6.3.2.1 Changing a User Password

Procedure

Step 1 Choose **Maintenance** > **Change Password** to access the password change screen.

Figure 6-63 Change Password

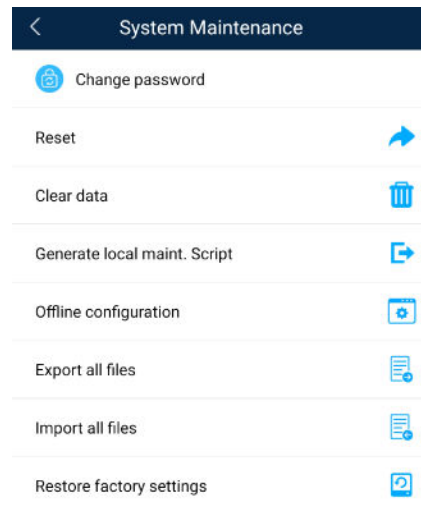

NOTE

The password must meet the following requirements:

- Contains 6–20 characters.
- Contains at least two of the following types: lowercase letters, uppercase letters, and digits.

----End

6.6.3.2.2 Resetting the System

Context

After the system resets, the SmartLogger restarts.

Procedure

Step 1 Choose **Maintenance** > **Reset**. A dialog box for resetting the system is displayed.

Figure 6-64 Reset

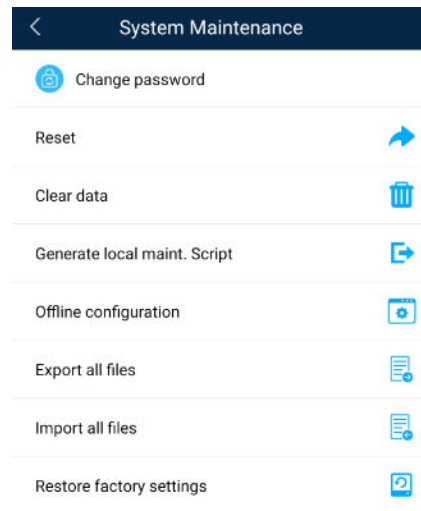

Step 2 Enter the password for logging in to the app, and tap **Confirm**.

----End

6.6.3.2.3 Clearing Data

Context

Clear data if the SmartLogger is relocated and its historical data needs to be deleted.

NOTICE

- After you perform **Clear Data**, electric energy yield data, performance data, and alarms are cleared from the SmartLogger.
- After you perform **Clear Data**, the devices connected to the SmartLogger are not removed. If the original device will no longer connect to the SmartLogger, remove the device.
- If you perform **Clear Data** on the SmartLogger, you also have to perform **Reset Alarms** on the NMS. Otherwise, the alarm information collected by the NMS and SmartLogger will be different.

Procedure

Step 1 Choose **Maintenance > Clear Data**. A dialog box for clearing data is displayed.

Figure 6-65 System Maintenance

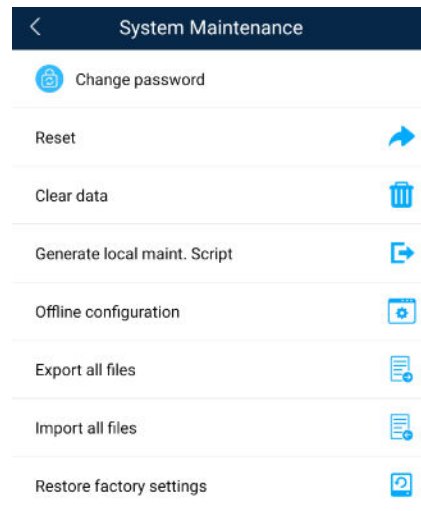

Step 2 Enter the password for logging in to the app, and tap **Confirm**.

----End

6.6.3.2.4 Generating the Local Maintenance Script

Prerequisites

A USB flash drive has been inserted into the USB port on the SmartLogger.

Context

Generating the local maintenance script is used to set SmartLogger commands and save the script file in the USB flash drive. The SmartLogger executes the local script file in the USB flash drive to export SmartLogger logs, export or import all files, upgrade application software, and upgrade BSP.

Procedure

Step 1 Choose **Maintenance > Generate local maint. Script** to access the screen for generating the script.

Figure 6-66 System Maintenance

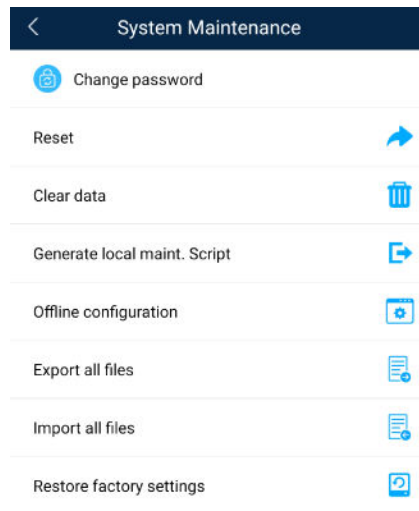

Step 2 Select operations as required and tap **Generate local maint. Script** to save the generated local maintenance script file in the USB flash drive.

----End

Follow-up Procedure

You can also set SmartLogger commands without logging in to the app. For details, see [8.3.2 SmartLogger Maintenance Script](#).

6.6.3.2.5 Restoring Factory Settings

Context

NOTICE

Perform this operation with caution because all configured parameters except the current date, time, baud rate, and address will be restored to their factory default values. This operation will not affect operating information, alarm records, or system logs.

Procedure

Step 1 Choose **Maintenance > Restore factory settings**. The **Restore factory** dialog box is displayed.

Figure 6-67 System Maintenance

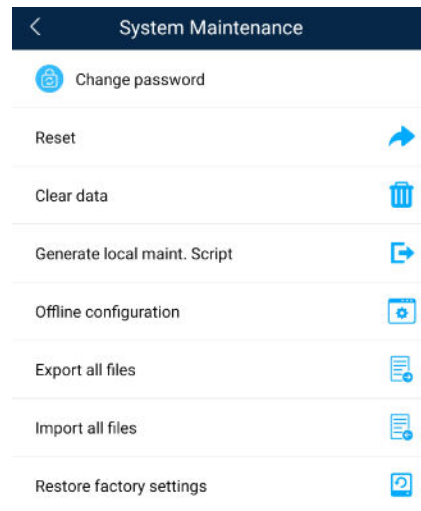

Step 2 Enter the password for logging in to the app, and tap **Confirm**.

----End

6.6.3.3 Device Management

You can choose **Maintenance > Device Mgmt** to manage all devices connected to the SmartLogger.

6.6.3.3.1 Changing a Device Name

Procedure

Step 1 Choose **Maintenance > Device Mgmt**. to access the **Device Mgmt**. screen.

Step 2 Tap a device name to change it.

Figure 6-68 Changing a device name



NOTE

The name of the SmartLogger cannot be changed.

----End

6.6.3.3.2 Deleting Devices

Procedure

- Step 1** Choose **Maintenance** > **Device Mgmt.** to access the **Device Mgmt.** screen.
- Step 2** Hold down a device name, select the devices to be deleted, and tap **Batch delete** to delete them.

Figure 6-69 Deleting devices

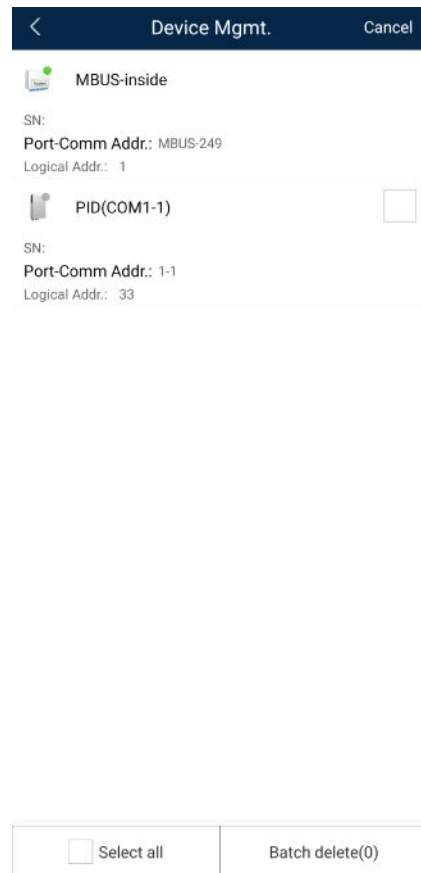

NOTE

Deleted devices are not displayed on the **Monitor** screen.

----End

6.6.3.3.3 Automatically Searching for Devices

Context

The SmartLogger can automatically detect and connect to devices.

The EMI, power meter, slave SmartLogger, and third-party devices cannot be automatically detected. You need to add them manually. For details, see [6.6.3.3.4 Manually Adding a Device](#).

Procedure

Step 1 Choose **Maintenance** > **Device Mgmt.** to access the **Device Mgmt.** screen.

Figure 6-70 Device management

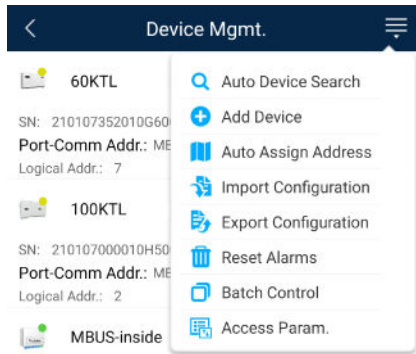

Step 2 Tap the drop-down list in the upper-right corner of the **Device Mgmt.** screen.

Step 3 Automatically searching for devices

----End

6.6.3.3.4 Manually Adding a Device

Context

The EMI, power meter, slave SmartLogger, and third-party devices cannot be automatically detected. You need to add them manually.

Procedure

Step 1 Choose **Maintenance > Device Mgmt.** to access the **Device Mgmt.** screen.

Figure 6-71 Device management

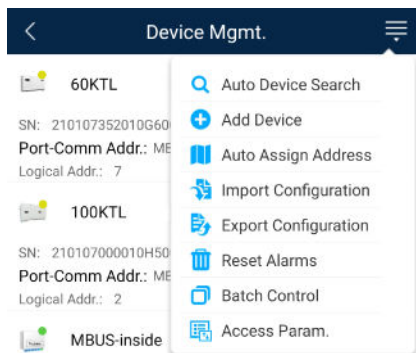

Step 2 Tap the drop-down list in the upper-right corner of the **Device Mgmt.** screen.

Step 3 Tap **Add Device** and set device parameters.

NOTE

- **Comm. Protocol** is set to **Modbus RTU** by default. If you need to modify it, refer to [6.5.4.5 Setting RS485 Parameters](#).

- Before adding the EMI or power meter manually, set the EMI or power meter parameters. For details, see *SmartLogger3000 User Manual*, *SmartLogger2000 User Manual* or *SmartLogger1000A User Manual*.

----End

6.6.3.3.5 Automatically Allocating Addresses

Context

The SmartLogger can automatically allocate addresses to the connected devices and adjust the addresses based on device sequence numbers.

Procedure

Step 1 Choose **Maintenance > Device Mgmt.** to access the **Device Mgmt.** screen.

Figure 6-72 Device management

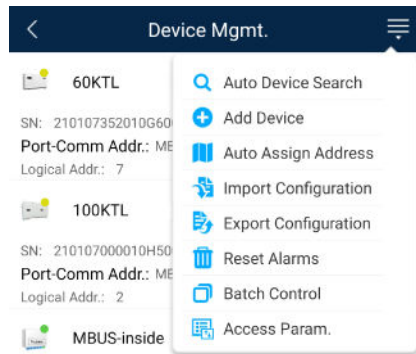

Step 2 Tap the drop-down list in the upper-right corner of the **Device Mgmt.** screen.

Step 3 Tap **Auto Assign Address**.

----End

6.6.3.3.6 Importing Configuration

Prerequisites

The name extension of the file to be imported must be **.cfg**. Otherwise, the file will be unavailable.

- The file to be imported is stored in the memory or SD card of the mobile phone.

Context

When connecting to a user-defined device or the IEC103 device, import a configuration file and add a device manually. Then, the device can be queried on the **Monitor** screen.

Procedure

Step 1 Choose **Maintenance > Device Mgmt.** to access the **Device Mgmt.** screen.

Figure 6-73 Device management

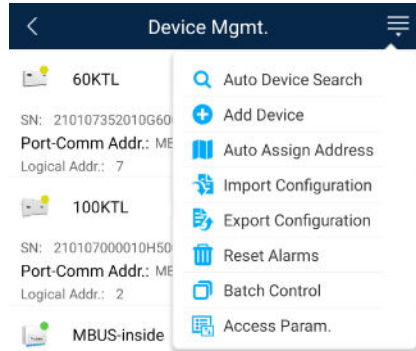

Step 2 Tap the drop-down list in the upper-right corner of the **Device Mgmt.** screen.

Step 3 Tap **Import Config** to import the **.cfg** file.

----End

6.6.3.3.7 Exporting Configuration

Context

After connecting to a third-party device, you can choose **Export Config** to view its configuration file.

Procedure

Step 1 Choose **Maintenance > Device Mgmt.** to access the **Device Mgmt.** screen.

Figure 6-74 Device management

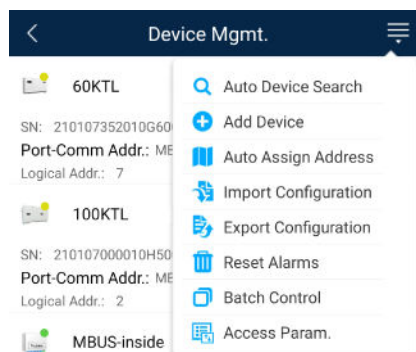

Step 2 Tap the drop-down list in the upper-right corner of the **Device Mgmt.** screen.

Step 3 Tap **Export Config**.

----End

6.6.3.3.8 Resetting Alarms

Context

- If you reset alarms, all the active and historical alarms of the selected device are deleted and the SmartLogger starts to collect new alarm data.
- If data is deleted for a solar inverter, you must reset alarms on the SmartLogger and the NMS; otherwise, the SmartLogger cannot collect new alarm data from the solar inverter.
- If alarms are reset on the SmartLogger, you must reset alarms on the NMS; otherwise, the NMS cannot obtain the new alarm data collected by the SmartLogger from the solar inverter.

Procedure

Step 1 Choose **Maintenance > Device Mgmt.** to access the **Device Mgmt.** screen.

Figure 6-75 Device management

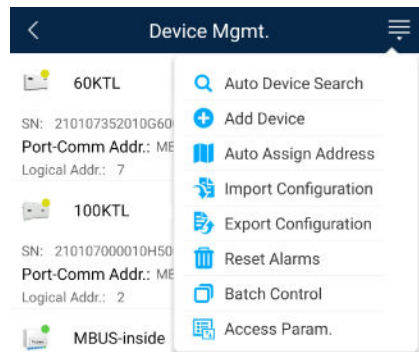

Step 2 Tap the drop-down list in the upper-right corner of the **Device Mgmt.** screen.

Step 3 Tap **Reset Alarms** and select a device on the **Reset Alarms** screen.

Step 4 Tap **Confirm**.

----End

6.6.3.3.9 Starting, Shutting down, and Resetting Solar Inverters in Batches

Context

Batch control operations allow the SmartLogger to start, shut down, and reset the connected solar inverters in batches. The solar inverters automatically restart after reset.

Procedure

Step 1 Choose **Maintenance > Device Mgmt.** to access the **Device Mgmt.** screen.

Figure 6-76 Device management

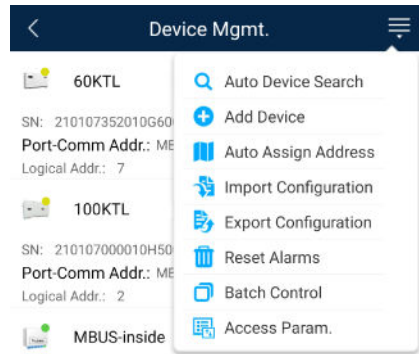

Step 2 Tap the drop-down list in the upper-right corner of the **Device Mgmt.** screen.

Step 3 Tap **Batch Control**.

Step 4 Tap **Batch startup**, **Batch shutdown**, or **Batch reset**, enter the app login password, and tap **Confirm**.

----End

6.6.3.3.10 Setting Access Parameter

Context

Before connecting a device to the SmartLogger, configure access parameters correctly.

Procedure

Step 1 Choose **Maintenance > Device Mgmt.** to access the **Device Mgmt.** screen.

Figure 6-77 Device management

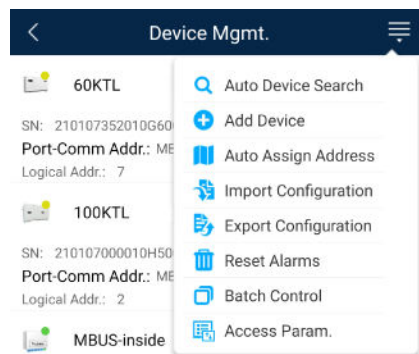

Step 2 Tap the drop-down list in the upper-right corner of the **Device Mgmt.** screen.

Step 3 Tap **Access Param.** to access the settings screen.

 **NOTE**

If the SmartLogger communicates with the solar inverter over the MBUS, set **Embedded MBUS enable** to **Enable**.

----End

6.6.3.4 Managing the Device List

Context

On the device list screen, you can choose **Export Device Info** > **Edit Device Info File** > **Import Device Info** to modify device information in the information file.

Procedure

Step 1 Choose **Maintenance** > **Device List** to access the device list screen.

Figure 6-78 Device List



Step 2 Tap **Export Device Info** to export the device information file.

 **NOTE**

The exported device information file is in .csv format.

Step 3 Tap **Edit Device Info File** to modify the device information file.

1. In the path where the device information file is exported, tap the exported .csv file to access the screen for modifying the file.
2. Tap a parameter to be modified and enter or select target information.
3. After all modifications, tap **Save** in the upper-right corner of the screen.

Step 4 Tap **Import Device Info** to import the modified device information file to the SmartLogger.

----End

6.6.3.5 Exporting Device Logs

Prerequisites

A USB flash drive has been inserted into the USB port on the SmartLogger.

Procedure

Step 1 Choose **Maintenance** > **Device logs** to access the device log screen.

Step 2 Tap  in the upper-right corner of the screen, select a device whose logs are to be exported, and tap **Next**.

Figure 6-79 Exporting device logs



Step 3 Select the types of logs to be exported and tap **Confirm** to start exporting device logs.

 **NOTE**

The downloaded device logs are saved at the storage path of the USB flash drive.

----End

6.6.3.6 Device Upgrade

Prerequisites

- You have obtained the upgrade package with the help of the supplier or Huawei engineers. After the downloading is complete, use the digital certificate and verification tool available at Huawei technical support website to verify the digital signature of the software package.
 - a. Log in to Huawei enterprise technical support website <http://support.huawei.com/enterprise>.
 - b. Browse or search for **PGP Verify**.
- Insert the USB flash drive where the upgrade package is saved into the USB port on the SmartLogger.

Procedure

Step 1 Choose **Maintenance > Upgrade** to access the device upgrade screen.

Figure 6-80 Device upgrade

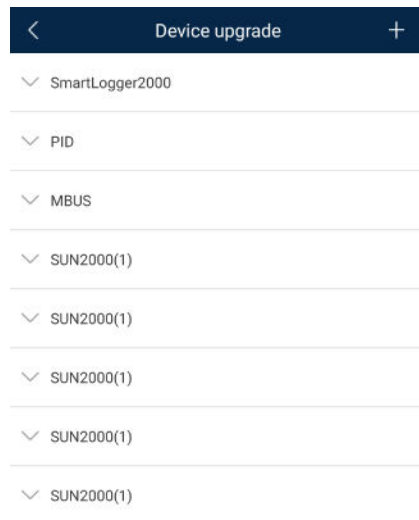

Step 2 Tap  in the upper-right corner, select a single device or devices of the same type, and tap **Next**.

Step 3 Select the upgrade package and tap **Next**.

Step 4 Confirm the upgrade package and the device to be upgraded, and tap **Finish** to start upgrading the device.

----End

6.6.3.7 Spot-Checking Solar Inverters

Context

You can perform spot-check for the solar inverter whose **Grid Code** is **Japan standard**.

Procedure

Step 1 Choose **Maintenance > Inverter Spot** to access the solar inverter spot-check screen.

Figure 6-81 Inverter spot

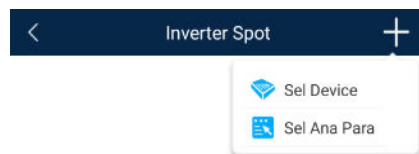

Step 2 (Optional) Tap  in the upper-right corner of the **Inverter Spot** screen, select **Sel Ana Para**, and tap **Finish** to set analog parameters.

 **NOTE**

After the parameters on the **Sel Analog Para** screen are set, the analog parameters and their values are displayed on the solar inverter spot-check screen. You can also tap **Sel Device** to set parameters when the solar inverters are being spot-checked.

Step 3 Tap  in the upper-right corner of the **Inverter Spot** screen and select **Sel Device** to access the **Sel Device** screen.

Step 4 Select one or more devices to be spot-checked, and then tap **Finish** to start spot-check.

----End

6.6.3.8 Feedback

Context

Users can provide feedback in text, pictures, and files.

 **NOTE**

Do not add private data.

Procedure

Step 1 Choose  > **Feedback** in the upper-right corner of the home screen.

Figure 6-82 Feedback



Step 2 Tap **Specify the type** and select **Feedback** or **Suggestion**.

Figure 6-83 Problem record

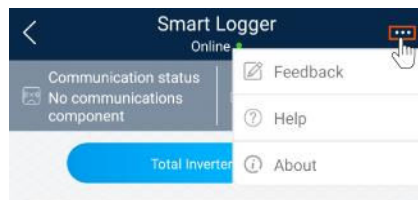
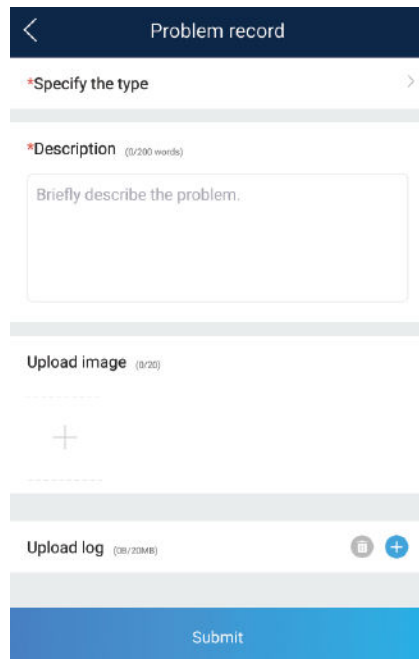

Step 3 Briefly describe the problem that you encounter in the **Description** column.

Step 4 (Optional) Tap  to upload pictures.

Step 5 (Optional) Tap  to upload logs. Select device logs or app logs as required.

Step 6 Tap **Submit**.

----End

6.6.3.9 Help

Context

If you have any questions when using an involved device or the app, search for solutions in the help information.

Procedure

Step 1 Choose  > **Help** in the upper-right corner of the home screen.

Figure 6-84 Help 1



Step 2 Specify your question. A solution will be displayed.

Figure 6-85 Help 2

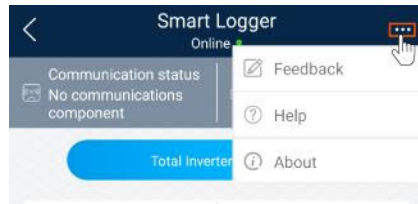
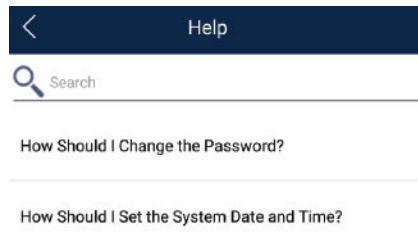

----End

6.6.3.10 About

Context

You can query the app version, connected product model, SN, firmware version, software ver., technical support website, privacy policy (displayed only on the SUN2000 app), customer service contact information, and open source software policy.

NOTE

- When the app starts for the first time after being downloaded or updated, the privacy policy is displayed. You can use the app only after agreeing to the privacy policy, and the privacy policy will no longer appear. If you do not agree to the privacy policy, the app exits, and the privacy policy is still displayed when you start the app next time until you agree to the privacy policy.
- You can revoke the agreed privacy policy.

Procedure

Step 1 In the upper-right corner of the home screen, choose  > **About** to view the app version, connected product model, SN, firmware version, software version, and technical support website.

Figure 6-86 About



Step 2 Tap **Privacy policy**, **Customer service contact information**, or **Open source software policy** to view the privacy policy, customer service contact information, and open source software policy.

----End

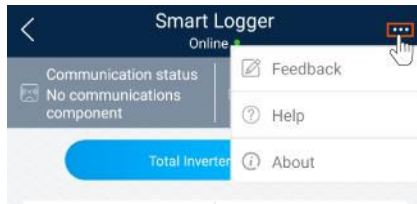
6.6.4 Device Monitoring

A special user can tap **Monitor** to query the running information and alarms about the SmartLogger and the devices connected to it, set parameters, and send commands.

6.6.4.1 Query

Step 1 On the home screen, tap **Monitor** to access the device monitoring screen.

Figure 6-87 Device monitoring

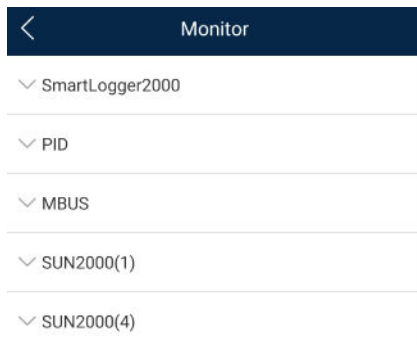

Step 2 Select a target device to access the function menu screen of the device.

Step 3 Tap **Alarm**, **Running Info.**, **Energy Yield**, or **About** to view the alarms, running information, energy yield, and version information about the device.

NOTE

- The displayed information varies according to the device type.
- The SmartLogger can connect to third-party devices that support the Modbus-RTU protocol, such as the box-type transformer and EMI. The SmartLogger cannot automatically search user-defined devices. You need to manually add them.
- The SmartLogger can connect to a maximum of five types of user-defined devices and can connect to multiple devices of the same type.
- The SmartLogger can connect to a third-party device that supports IEC103, such as a relay protection or monitoring device like a box-type transformer. The SmartLogger cannot automatically search IEC103 devices. You need to manually add them.

- The SmartLogger can connect to a maximum of five types of IEC103 devices and can connect to multiple devices of the same type.

----End

6.6.4.2 Settings

Context

An advanced user can set only the running parameters of solar inverters.

Procedure

- Step 1** Tap **SUN2000** on the **Monitor** screen and select the target device to access the function menu screen of the solar inverter.
- Step 2** Tap **Settings** to access the settings screen.
- Step 3** Set parameters as required.
- Step 4** (Optional) Select parameters as required and tap **Batch set** to set running parameters for multiple solar inverters of the same series.

----End

6.6.4.3 Maintenance

6.6.4.3.1 Log Download

Context

An advanced user can download only the logs of the SmartLogger, solar inverter, MBUS, and PID module.

Procedure

- Step 1** Select a device on the **Monitor** screen to access the function menu screen of the device.
- Step 2** Tap **Device Logs** to access the log download screen.
- Step 3** Download log files as required.

NOTE

- By default, Android system logs are saved in the **Android/data/com.huawei.smartpvms/files/inverterapp** folder in the phone memory. You can change the save path by referring to "Setting a File Save Path".
- The downloaded solar inverter logs are saved at the **Device Log** directory in **File Manager** in your mobile phone. You can also send the logs to your mailbox for checking.

----End

6.6.4.3.2 Solar Inverter Maintenance

Procedure

Step 1 Tap **SUN2000** on the **Monitor** screen and select the target device to access the function menu screen of the solar inverter.

Step 2 Tap **Maintenance** to access the maintenance screen.

Step 3 Tap  next to **Power on** or **Power off** to perform the operation.

 **NOTE**

Tap **Performance Data** to view the performance data curve of the solar inverter.

Step 4 Enter the password for logging in to the app, and tap **Confirm**.

----End

7 Operations on the Screen for Connecting to the PID Module

7.1 PID Module

Connection Modes

After the SmartPID2000 (PID module for short) is powered on, it can connect to the app over a WLAN module, a Bluetooth module, or a USB data cable.

Table 7-1 Product mapping (Android)

PID Module	PID Module Version	App Version	Connection Mode	
			USB-Adapter2000-C WLAN Module/USB-Adapter2000-B Bluetooth Module	USB Data Cable
SmartPID2000	SmartPID2000 V100R001C00 and later versions	3.2.00.005	Supported	

Table 7-2 Product mapping (iOS)

PID Module	PID Module Version	App Version	Connection Mode	
			USB-Adapter2000-B Bluetooth Module	USB Data Cable
SmartPID2000	SmartPID2000 V100R001C00 and	2.2.00.050	Supported	Not supported

PID Module	PID Module Version	App Version	Connection Mode	
			USB-Adapter2000-B Bluetooth Module	USB Data Cable
	later versions			

7.2 Required Accessories

Mobile Phone

- Mobile phone operating system: Android 4.4 or later.
- Recommended phone brands: Huawei and Samsung.
- The mobile phone supports the access to the Internet over a web browser.
- WLAN/Bluetooth supported.

WLAN/Bluetooth Module

Purchase a WLAN/Bluetooth module that matches the PID module. A WLAN/Bluetooth module purchased from any other source may not support communication between the app module and the PID module.

Table 7-3 WLAN/Bluetooth module model

Model	Module	Item Code	Purchased From
USB-Adapter2000-C	WLAN module	02312MCK	Can be purchased from Huawei
USB-Adapter2000-B	Bluetooth module	02311NEA	
BF4030	Bluetooth module	06080358	

USB Data Cable

The USB data cable is delivered with the phone.

7.3 User Operation Permissions

The user accounts that can log in to the app are classified into common users, special users, and advanced users based on the responsibilities of PV plant operation personnel.

- Common user: Has the permissions of viewing PID module data and setting user parameters.

- Advanced users: Has the permissions of viewing PID module data, setting functional parameters, and maintaining devices.
- Special user: Has the permissions of viewing PID module data, setting user parameters, and maintaining devices (including starting and shutting down the PID module, clearing data, and upgrading devices).

Figure 7-1, Figure 7-2 and Figure 7-3 show the menu operation permissions of common users, advanced users, and special users respectively.

Figure 7-1 Operation permissions of common users

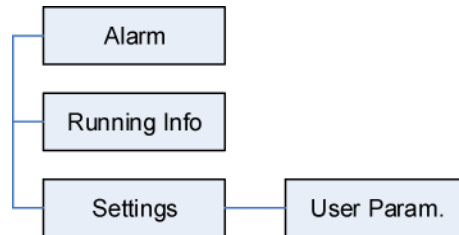
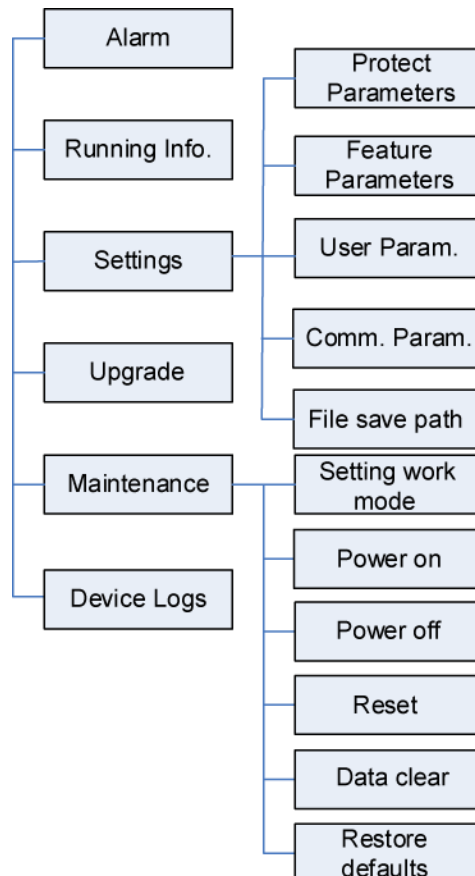

Figure 7-2 Operation permissions of advanced users



NOTE

File save path is available only for Android system.

Figure 7-3 Operation permissions of special users

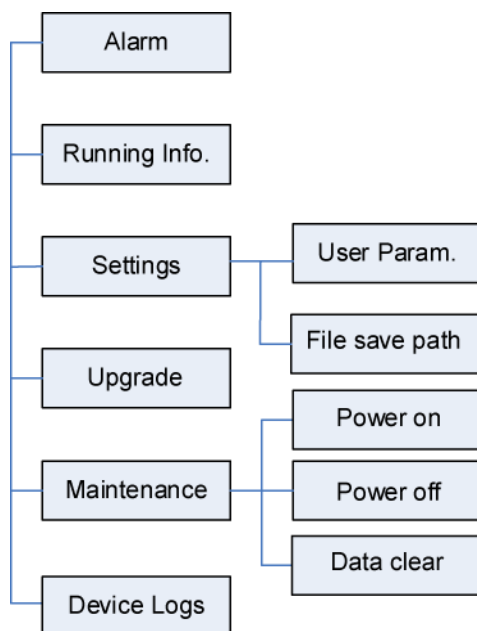

NOTE

File save path is available only for Android system.

7.4 Login

Prerequisites

- The PID module has been powered on.
- Connect over a Bluetooth module:
 - a. A WLAN/Bluetooth module is available and has been inserted into the USB port in the PID module maintenance compartment.
 - b. The WLAN/Bluetooth function is enabled on the mobile phone.
 - c. Keep the mobile phone within 5 m away from the PID module. Otherwise, communication between them would be affected.
- Connect over a USB data cable:
 - a. A USB data cable is available. One end of the USB data cable is connected to the USB port in the PID module maintenance compartment and the other end is connected to the USB port on the mobile phone.
 - b. After connecting the USB data cable, **Connected to USB Accessory** is displayed on the mobile phone, indicating that the PID module and the mobile phone have been successfully connected. Otherwise, the USB data cable connection is invalid.

Procedure

- Step 1** Start the app. Tap **Connect** to access the code scanning screen and connect to the PID module.

Figure 7-4 Connect

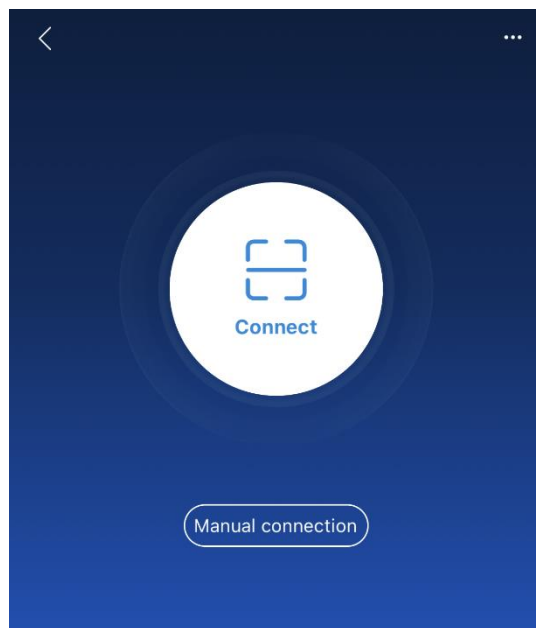

Connection record

- Code scanning: Tap **Connect**, on the scanning screen, place the QR code or bar code of the WLAN/Bluetooth module in the scan frame. The device will be automatically connected after the code is identified.
- Manual connection: Tap **Manual Connection** and select a connection mode.

Figure 7-5 Manual connection



- Select **WLAN** and connect to the corresponding WLAN in the WLAN connection list of the APP. The initial name of the WLAN hotspot is **Adapter-WLAN module SN**, and the initial password is **Changeme**.

NOTICE

Use the initial password upon first power-on and change it immediately after login. To ensure account security, change the password periodically and keep the new password in mind. Not changing the initial password may cause password disclosure. A password left unchanged for a long period of time may be stolen or cracked. If a password is lost, devices cannot be accessed. In these cases, the user is liable for any loss caused to the PV plant.

- Select **Bluetooth**, and tap **Search for device**. After a Bluetooth device is found, select the target Bluetooth device, and set up a connection. If the Bluetooth module is USB-Adapter2000-B, the connected Bluetooth device is named after last 8 digits of the SN barcode + HWAPP. The SN barcode can be obtained from the silk screen on the Bluetooth module.
- Select **USB**, and tap **Confirm** to allow the app to access the USB accessory. After you select **Use by default for this USB accessory**, the message will not appear if you log in to the app again without removing the USB data cable.

Step 2 Select a login user and enter the password.

NOTE

- The login password is the same as that for the PID module connected to the app and is used only when the PID module connects to the app.

- The initial passwords for **Common User**, **Advanced User**, and **Special User** are all **00000a**. If you log in to the system for the first time, use the initial password and change the password as soon as possible. After the password is used for a period of time, change it periodically to ensure account security.
- During the login, if five consecutive invalid password entries are made (the interval between two consecutive entries is less than 2 minutes), the account will be locked for 10 minutes. The password should consist of six characters.

Step 3 After successful login, the **Quick Settings** screen or **Function Menu** screen is displayed.

 **NOTE**

- If you log in to the app after the PID module powers on for the first time or factory defaults are restored, the **Quick Settings** screen will be displayed. You can set basic parameters for the PID module on the **Quick Settings** screen. After the settings take effect, you can access the **Function Menu** screen and modify the parameters on the **Settings** screen.
- If you do not set basic parameters for the PID module on the **Quick Settings** screen, the screen is still displayed when you log in to the app next time.

----End

7.5 Screen Operations (Common User)

7.5.1 Query

Procedure

Step 1 After logging in to the app, you can view the PID module working mode and compensation mode on the home screen.

Figure 7-6 Home screen

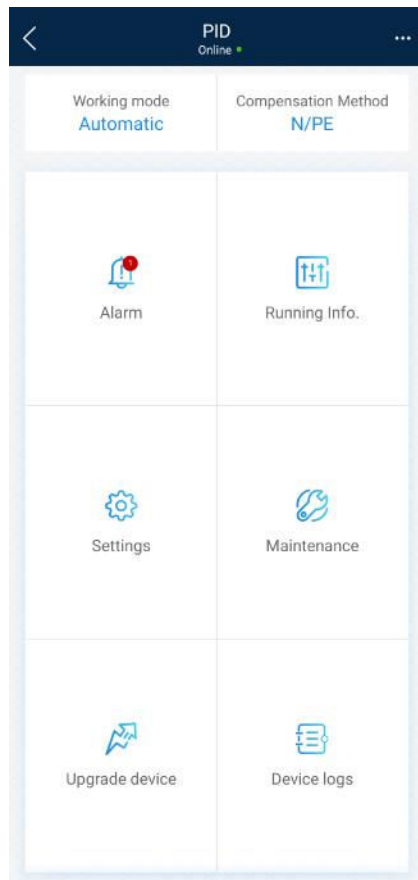



Step 2 Tap **Alarms** or **Running Info.** to view active alarms, historical alarms, and PID module running information.

You can view the following information on the alarm information screen:

- Tap an alarm record and view the alarm details.
- Swipe right or left on the screen or tap either **Active Alarm** or **Historical Alarm** to display a list of active alarms or historical alarms.

 **NOTE**

- Tap  to set the alarm sorting mode for active alarms or historical alarms.
- Tap  to set a time criterion. The historical alarms generated within the time segment are displayed.

----End

7.5.2 Settings

Prerequisite

Common users can set user parameters only for the PID module.

Procedure

Step 1 On the home screen, choose **Settings > User Parameters** and set user parameters.

Figure 7-7 User parameters

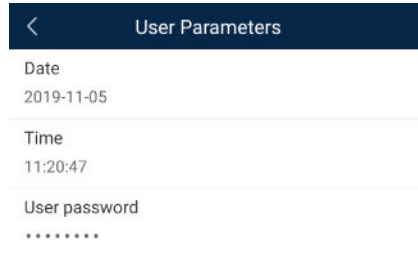

NOTE

The password must meet the following requirements:

- Contains six characters.
- Contains at least two of the three types: lowercase letters, uppercase letters, and digits.

----End

7.5.3 Maintenance

7.5.3.1 Feedback

Context

Users can provide feedback in text, pictures, and files.

NOTE

Do not add private data.

Procedure

Step 1 Choose  > **Feedback** in the upper-right corner of the home screen.

Figure 7-8 Feedback



Step 2 Tap **Specify the type** and select **Feedback** or **Suggestion**.

Figure 7-9 Problem record

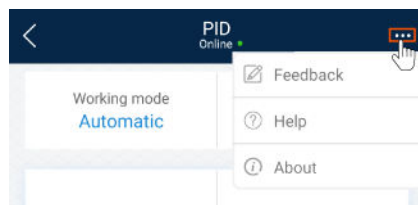
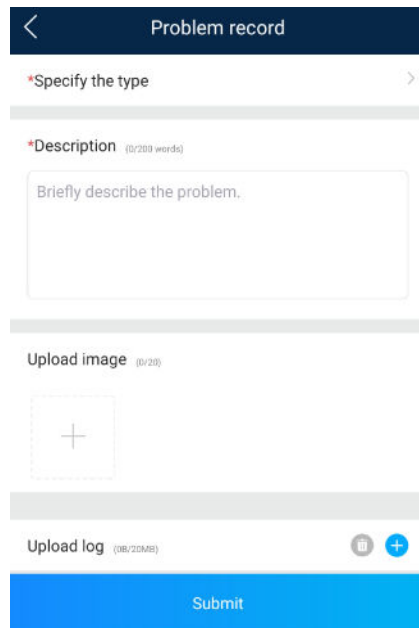

Step 3 Briefly describe the problem that you encounter in the **Description** column.

Step 4 (Optional) Tap  to upload pictures or logs.

Step 5 (Optional) Tap  to upload logs. Select device logs or app logs as required.

Step 6 Tap **Submit**.

----End

7.5.3.2 Help

Context

If you have any questions when using an involved device or the app, search for solutions in the help information.

Procedure

Step 1 Choose  > **Help** in the upper-right corner of the home screen.

Figure 7-10 Help



Step 2 Specify your question. A solution will be displayed.

Figure 7-11 Help 2

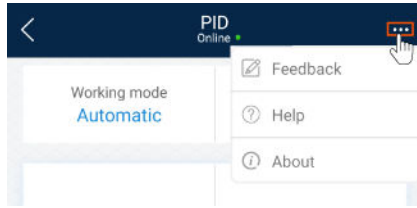
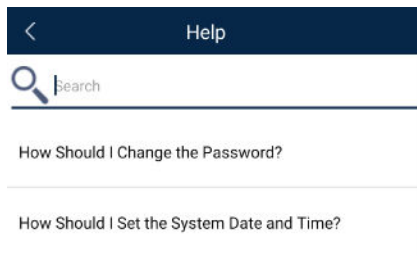

----End

7.5.3.3 About

Context

You can query the app version, connected product model, SN, firmware version, software ver., technical support website, privacy policy, customer service contact information, and open source software policy.

NOTE

- When the app starts for the first time after being downloaded or updated, the privacy policy is displayed. You can use the app only after agreeing to the privacy policy, and the privacy policy will no longer appear. If you do not agree to the privacy policy, the app exits, and the privacy policy is still displayed when you start the app next time until you agree to the privacy policy.
- You can revoke the agreed privacy policy.

Procedure

Step 1 In the upper-right corner of the home screen, choose  > **About** to view the app version, connected product model, SN, firmware version, software version, and technical support website.

Figure 7-12 About



Step 2 Tap **Privacy policy**, **Customer service contact information**, or **Open source software policy** to view the privacy policy, customer service contact information, and open source software policy.

----End

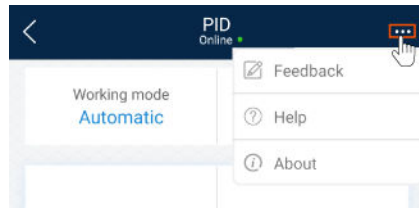
7.6 Screen Operations (Advanced User)

7.6.1 Query

Procedure

Step 1 After logging in to the app, you can view the PID module working mode and compensation mode on the home screen.

Figure 7-13 Home screen

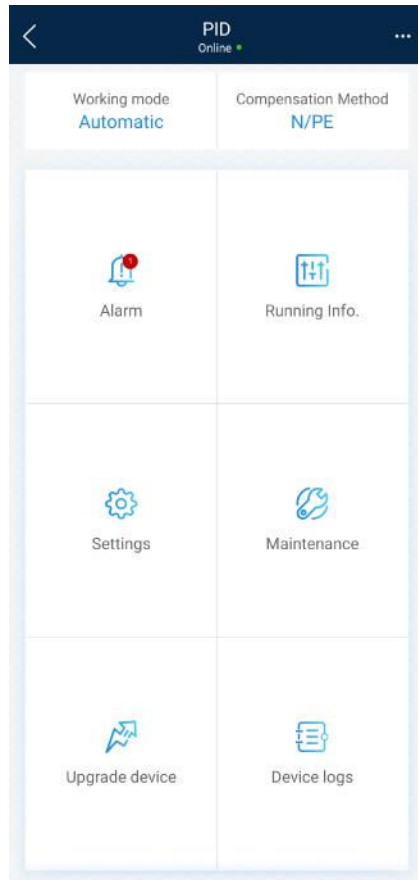



Step 2 Tap **Alarms** or **Running Info.** to view active alarms, historical alarms, and PID module running information.

You can view the following information on the alarm information screen:

- Tap an alarm record and view the alarm details.
- Swipe right or left on the screen or tap either **Active Alarm** or **Historical Alarm** to display a list of active alarms or historical alarms.

 **NOTE**

- Tap  to set the alarm sorting mode for active alarms or historical alarms.
- Tap  to set a time criterion. The historical alarms generated within the time segment are displayed.

----End

7.6.2 Settings

7.6.2.1 Setting Protection Parameters

Procedure

- Step 1** On the home screen, choose **Settings > Protection Parameters** to access the parameter setting screen.

Figure 7-14 Protection parameters

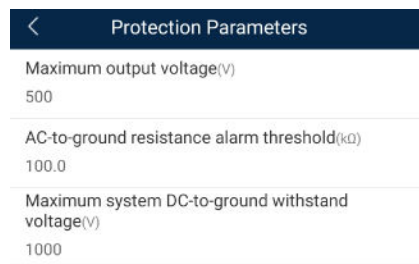

Table 7-4 Parameter description

No.	Parameter	Description	Unit	Remarks
1	Maximum output voltage	Specifies the highest step-up voltage of the PID module in normal or commissioning mode.	V	<p>The default value is 500 V. For the 1500 V SUN2000, the recommended value is 800 V.</p> <ul style="list-style-type: none"> For the 1000 V/1100 V SUN2000, the value ranges from 0 V to 550 V. The parameter value indicates the maximum DC step-up voltage between PV and the ground. For the 1500 V SUN2000, the value ranges from 0 V to 800 V. The parameter value indicates the maximum DC step-up voltage between PV and the ground.
2	AC-to-ground resistance alarm threshold	Specifies the alarm threshold for the impedance between the AC side of the PID module and the ground.	kΩ	You can set an alarm threshold for the impedance between the AC grid and the ground for the PID module. If the detected impedance is below the threshold, the PID module will generate an alarm.
3	Maximum system DC-	Specifies the voltages between	V	Specifies the lower threshold of the maximum voltage range

No.	Parameter	Description	Unit	Remarks
	to-ground withstand voltage	the PV side and the ground and between the AC side and the ground in normal mode.		between the solar inverter DC side (including the solar inverter, PV module, cable, SPD, and switch) and the ground. The default value is 1000 V. For the 1500 V SUN2000, the recommended value is 1500 V.

----End

7.6.2.2 Setting Feature Parameters

Procedure

Step 1 On the home screen, choose **Settings > Feature Parameters** to access the parameter setting screen.

Figure 7-15 Feature parameters



Table 7-5 Parameter description

No.	Parameter	Description	Unit	Remarks
1	Offset mode	Specifies the compensation mode of the PID module.	-	<ul style="list-style-type: none"> Select Disable if the PID module is not required. Select N/PE if the PID module is required to use voltage output from the power grid.

No.	Parameter	Description	Unit	Remarks
2	Compensation offset voltage	Specifies the compensation offset voltage between PV and the ground after the PID module operates stably.	V	<ul style="list-style-type: none"> If PV module compensation voltage direction is set to PV– positive offset, this parameter specifies the positive voltage between PV– and the ground. If PV module compensation voltage direction is set to PV+ negative offset, this parameter specifies the negative voltage between PV+ and the ground. <p>NOTE If Compensation offset voltage is set to 500 V, the PID module provides the maximum output to enhance the voltage compensation effect. The output voltage amplitude of the PID module is automatically capped to ensure the safety of a PV plant. The output voltage amplitude is also related to the maximum system DC-to-ground withstand voltage and maximum output voltage.</p>
3	PV module compensation voltage direction	Specifies the offset direction of the PID module.	-	For the specific PV module compensation type, consult the PV module vendor. For example, P-type PV modules, HIT, CIS, thin-film PV modules, and CdTe PV modules meet the requirement for PV– positive offset.
4	Modbus version number	Specifies the version number of the Modbus protocol of the PID module.	-	-
5	IMD access	Specifies whether the PID module and insulation monitor device (IMD) can operate in cycle mode.	-	<ul style="list-style-type: none"> Select Enable if you allow the PID module and IMD to operate in cycle mode. <p>Only the IMDs of mainstream suppliers such as DOLD and BENDER are supported, and the IMDs must have enabled</p>

No.	Parameter	Description	Unit	Remarks
				dry contacts. NOTICE You can set Periodic PID runtime and Periodic IMD runtime only when IMD access is set to Enable . • Select Disable if you forbid the access of IMDs.
6	Periodic PID runtime	Specifies the operating duration of the PID module when the PID module and IMD operate in cycle mode.	min	The IMD is shut down when the PID module is operating.
7	Periodic IMD runtime	Specifies the operating duration of the IMD when the PID module and IMD operate in cycle mode.	min	The PID module is standby when the IMD is operating.

----End

7.6.2.3 Setting User Parameters

Procedure

Step 1 On the home screen, choose **Settings > User Parameters** to access the parameter setting screen.

Figure 7-16 User parameters

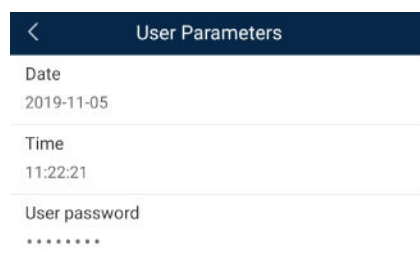

NOTE

The password must meet the following requirements:

- Contains six characters.
- Contains at least two of the three types: lowercase letters, uppercase letters, and digits.

----End

7.6.2.4 Setting Communications Parameters

Procedure

- Step 1** On the home screen, choose **Settings** > **Comm. Parameters** to access the parameter setting screen.
- Step 2** Tap **RS485** to set RS485 communications parameters.

Figure 7-17 Communications parameters

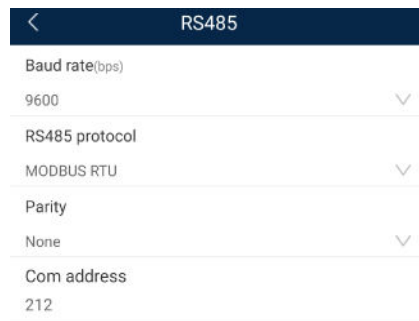

----End

7.6.2.5 Setting a File Save Path

Prerequisites

This function is available only on the Android system.

Context

You can modify the save path for operation logs and PID module logs and export logs from the path.

Procedure

- Step 1** On the home screen, choose **Settings** > **File Save Path** to access the path setting screen.

Figure 7-18 File save path



Step 2 Tap **File save path** to set a file save path.

----End

7.6.3 Maintenance

7.6.3.1 Log Download

Context

On the **Device Logs** screen, you can export operation logs and PID logs from the mobile phone.

Procedure

Step 1 On the home screen, tap **Device Logs** to access the log download screen.

Figure 7-19 Downloading logs

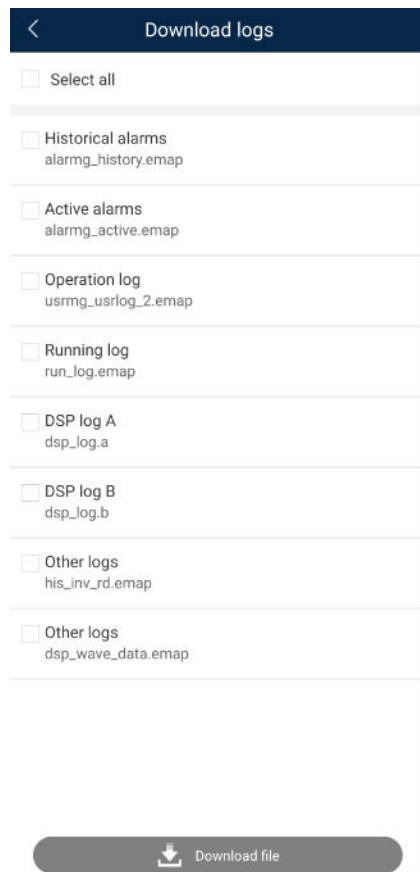

Step 2 Download log files as required.

 **NOTE**

- By default, Android system logs are saved in the **Android/data/com.huawei.smartpvms/files/inverterapp** folder in the phone memory. You can change the save path by referring to "Setting a File Save Path".
- The downloaded solar inverter logs are saved at the **Device Log** directory in **File Manager** in your mobile phone. You can also send the logs to your mailbox for checking.

----End

7.6.3.2 System Maintenance

Procedure

Step 1 On the home screen, tap **Maintenance** to access the maintenance screen.

Figure 7-20 Maintenance

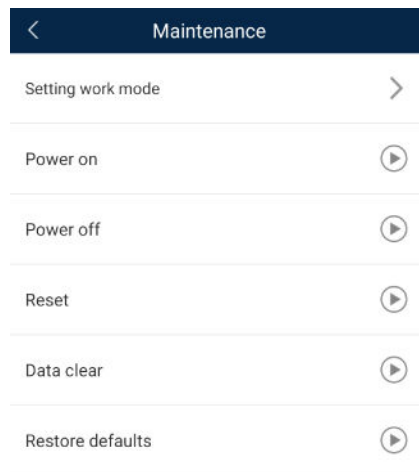

Step 2 Tap **Setting work mode** to set working mode parameters.

Figure 7-21 Setting work mode

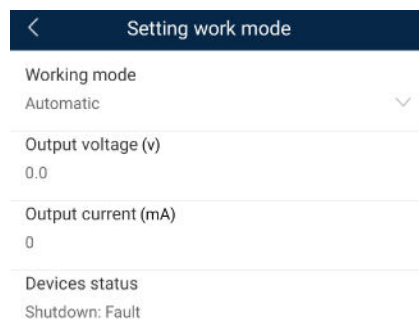

Step 3 Tap  next to **Power on**, **Power off**, **Reset**, **Data clear**, or **Restore defaults** as required.

 **NOTE**

- If you clear data, active and historical alarms stored on the PID module will all be cleared.
- Tap **Performance Data** to view the performance data curve of the PID module.

Step 4 Enter the password for logging in to the app, and tap **Confirm**.

----End

7.6.3.3 Device Upgrade

Prerequisites

Obtain the upgrade package from your supplier or Huawei engineers. After the downloading is complete, use the digital certificate and verification tool available at Huawei technical support website to verify the digital signature of the software package.

1. Log in to Huawei enterprise technical support website
<http://support.huawei.com/enterprise>.
2. Browse or search for **PGP Verify**.

Procedure

Step 1 Copy the upgrade package to your mobile phone without decompressing the package.

Step 2 Tap **Upgrade** to access the PID module upgrade screen. Upgrade the software version of the device as required.

Figure 7-22 PID Upgrade

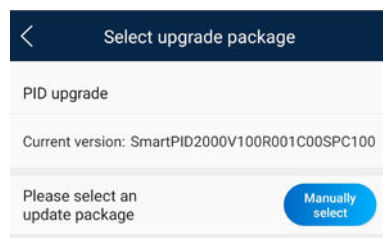

----End

7.6.3.4 Feedback

Context

Users can provide feedback in text, pictures, and files.

 **NOTE**

Do not add private data.

Procedure

Step 1 Choose  > **Feedback** in the upper-right corner of the home screen.

Figure 7-23 Feedback



Step 2 Tap **Specify the type** and select **Feedback** or **Suggestion**.

Figure 7-24 Problem record

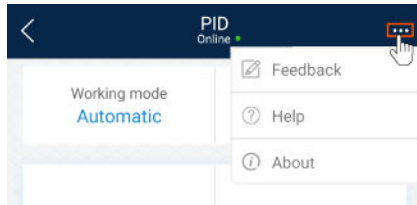
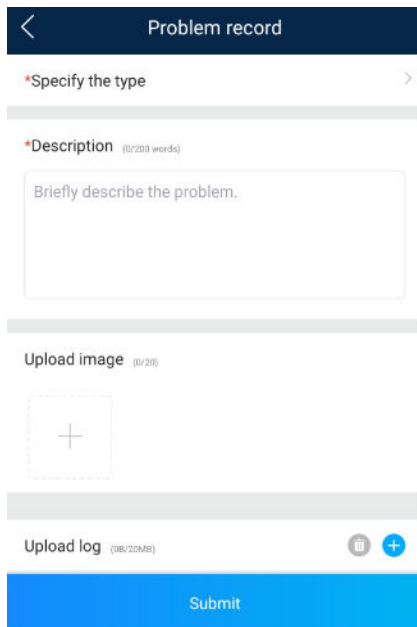

Step 3 Briefly describe the problem that you encounter in the **Description** column.

Step 4 (Optional) Tap  to upload pictures or logs.

Step 5 (Optional) Tap  to upload logs. Select device logs or app logs as required.

Step 6 Tap **Submit**.

----End

7.6.3.5 Help

Context

If you have any questions when using an involved device or the app, search for solutions in the help information.

Procedure

Step 1 Choose  > **Help** in the upper-right corner of the home screen.

Figure 7-25 Help



Step 2 Specify your question. A solution will be displayed.

Figure 7-26 Help 2

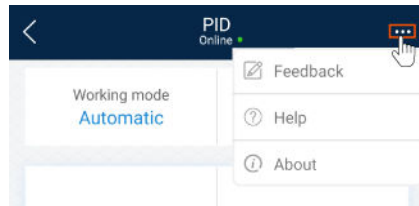
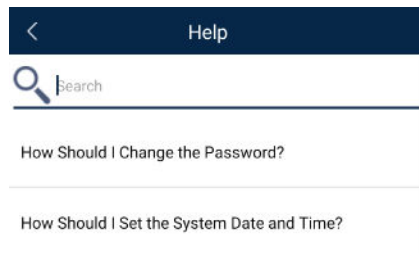

----End

7.6.3.6 About

Context

You can query the app version, connected product model, SN, firmware version, software ver., technical support website, privacy policy, customer service contact information, and open source software policy.

NOTE

- When the app starts for the first time after being downloaded or updated, the privacy policy is displayed. You can use the app only after agreeing to the privacy policy, and the privacy policy will no longer appear. If you do not agree to the privacy policy, the app exits, and the privacy policy is still displayed when you start the app next time until you agree to the privacy policy.
- You can revoke the agreed privacy policy.

Procedure

- Step 1** In the upper-right corner of the home screen, choose  > **About** to view the app version, connected product model, SN, firmware version, software version, and technical support website.

Figure 7-27 About



- Step 2** Tap **Privacy policy**, **Customer service contact information**, or **Open source software policy** to view the privacy policy, customer service contact information, and open source software policy.

----End

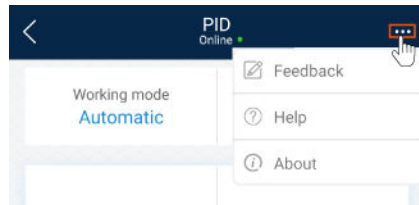
7.7 Screen Operations (Special User)

7.7.1 Query

Procedure

- Step 1** After logging in to the app, you can view the PID module working mode and compensation mode on the home screen.

Figure 7-28 Home screen

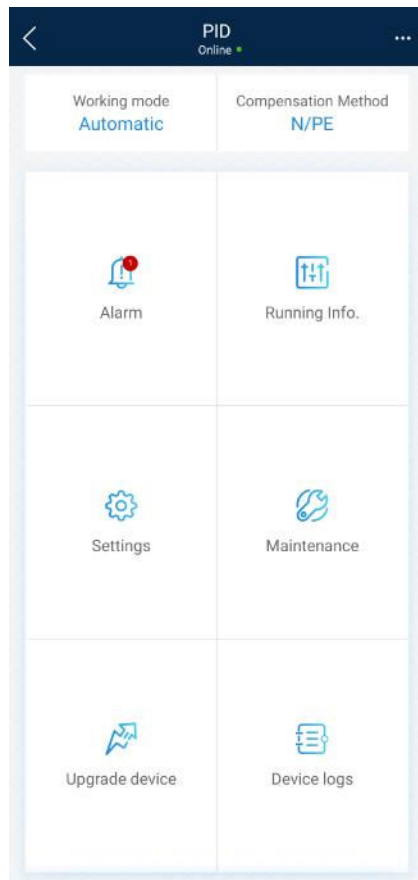



Step 2 Tap **Alarms** or **Running Info.** to view active alarms, historical alarms, and PID module running information.

You can view the following information on the alarm information screen:

- Tap an alarm record and view the alarm details.
- Swipe right or left on the screen or tap either **Active Alarm** or **Historical Alarm** to display a list of active alarms or historical alarms.

 **NOTE**

- Tap  to set the alarm sorting mode for active alarms or historical alarms.
- Tap  to set a time criterion. The historical alarms generated within the time segment are displayed.

----End

7.7.2 Settings

7.7.2.1 Setting User Parameters

Procedure

- Step 1** On the home screen, choose **Settings** > **User Parameters** to access the parameter setting screen.

Figure 7-29 User parameters



NOTE

The password must meet the following requirements:

- Contains six characters.
- Contains at least two of the three types: lowercase letters, uppercase letters, and digits.

----End

7.7.2.2 Setting a File Save Path

Prerequisites

This function is available only on the Android system.

Context

You can modify the save path for operation logs and PID module logs and export logs from the path.

Procedure

- Step 1** On the home screen, choose **Settings** > **File Save Path** to access the path setting screen.

Figure 7-30 File save path



- Step 2** Tap **File save path** to set a file save path.

----End

7.7.3 Maintenance

7.7.3.1 Log Download

Context

On the **Device Logs** screen, you can export operation logs and PID logs from the mobile phone.

Procedure

Step 1 On the home screen, tap **Device Logs** to access the log download screen.

Figure 7-31 Downloading logs

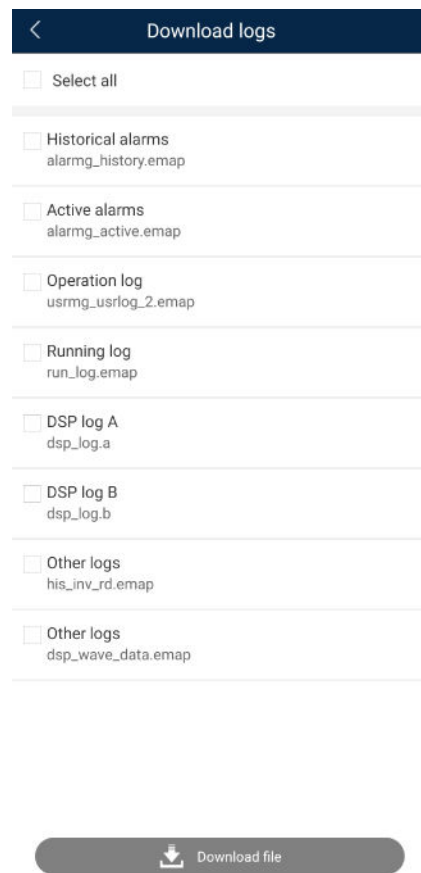

Step 2 Download log files as required.

NOTE

- By default, Android system logs are saved in the **Android/data/com.huawei.smartpvms/files/inverterapp** folder in the phone memory. You can change the save path by referring to "Setting a File Save Path".
- The downloaded solar inverter logs are saved at the **Device Log** directory in **File Manager** in your mobile phone. You can also send the logs to your mailbox for checking.

----End

7.7.3.2 System Maintenance

Procedure

Step 1 On the home screen, tap **Maintenance** to access the maintenance screen.

Figure 7-32 Maintenance



Step 2 Tap  next to **Power on**, **Power off**, or **Data clear** as required.

NOTE

- If you clear data, active and historical alarms stored on the PID module will all be cleared.
- Tap **Performance Data** to view the performance data curve of the PID module.

Step 3 Enter the password for logging in to the app, and tap **Confirm**.

----End

7.7.3.3 Device Upgrade

Prerequisites

Obtain the upgrade package from your supplier or Huawei engineers. After the downloading is complete, use the digital certificate and verification tool available at Huawei technical support website to verify the digital signature of the software package.

1. Log in to Huawei enterprise technical support website <http://support.huawei.com/enterprise>.
2. Browse or search for **PGP Verify**.

Procedure

Step 1 Copy the upgrade package to your mobile phone without decompressing the package.

Step 2 Tap **Upgrade** to access the PID module upgrade screen. Upgrade the software version of the device as required.

Figure 7-33 PID Upgrade

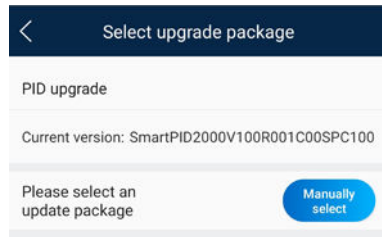

----End

7.7.3.4 Feedback

Context

Users can provide feedback in text, pictures, and files.

 **NOTE**

Do not add private data.

Procedure

Step 1 Choose  > **Feedback** in the upper-right corner of the home screen.

Figure 7-34 Feedback



Step 2 Tap **Specify the type** and select **Feedback** or **Suggestion**.

Figure 7-35 Problem record

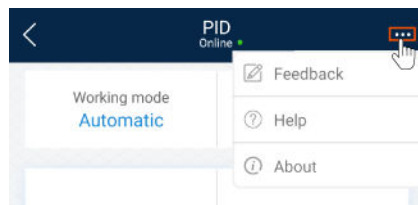
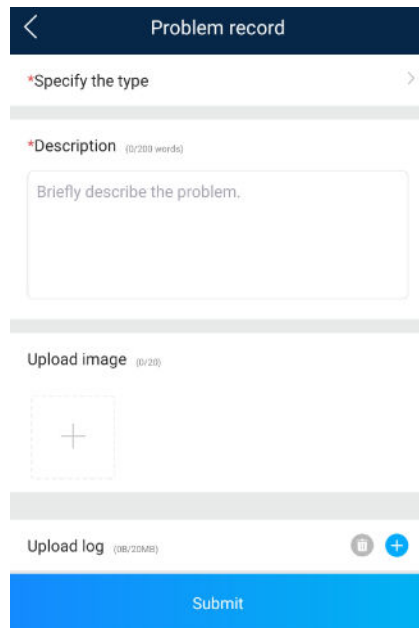

Step 3 Briefly describe the problem that you encounter in the **Description** column.

Step 4 (Optional) Tap  to upload pictures or logs.

Step 5 (Optional) Tap  to upload logs. Select device logs or app logs as required.

Step 6 Tap **Submit**.

----End

7.7.3.5 Help

Context

If you have any questions when using an involved device or the app, search for solutions in the help information.

Procedure

Step 1 Choose  > **Help** in the upper-right corner of the home screen.

Figure 7-36 Help



Step 2 Specify your question. A solution will be displayed.

Figure 7-37 Help 2

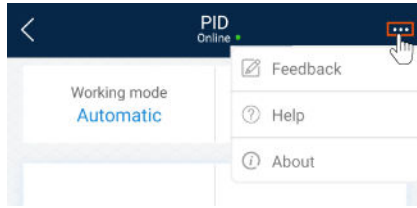
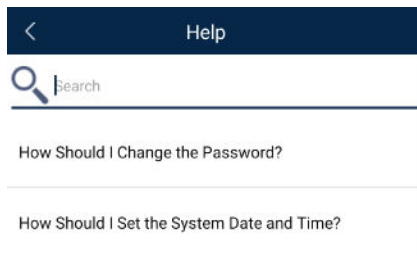

----End

7.7.3.6 About

Context

You can query the app version, connected product model, SN, firmware version, software ver., technical support website, privacy policy, customer service contact information, and open source software policy.

NOTE

- When the app starts for the first time after being downloaded or updated, the privacy policy is displayed. You can use the app only after agreeing to the privacy policy, and the privacy policy will no longer appear. If you do not agree to the privacy policy, the app exits, and the privacy policy is still displayed when you start the app next time until you agree to the privacy policy.
- You can revoke the agreed privacy policy.

Procedure

Step 1 In the upper-right corner of the home screen, choose  > **About** to view the app version, connected product model, SN, firmware version, software version, and technical support website.

Figure 7-38 About



Step 2 Tap **Privacy policy**, **Customer service contact information**, or **Open source software policy** to view the privacy policy, customer service contact information, and open source software policy.

----End

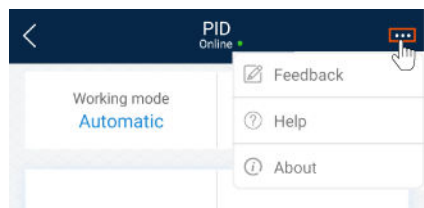
8 SUN2000 APP Tool Kit

8.1 File download

Context

Downloading app logs, inverter upgrade packages and grid codes is supported.

Procedure

Step 1 On the app connection screen, tap  > **File download** in the upper-right corner.

Figure 8-1 File download

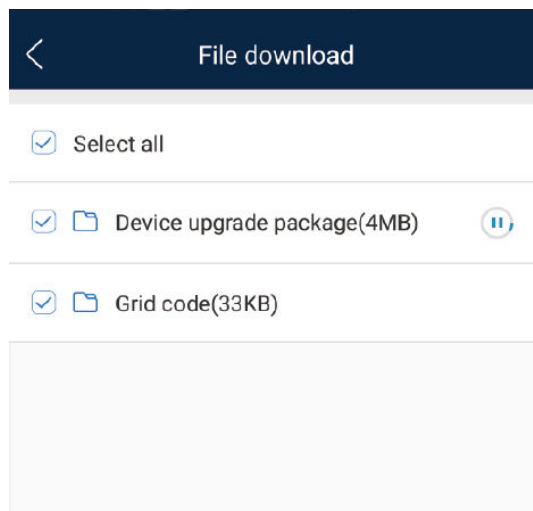

Step 2 If an update of device upgrade package is detected, confirm to download it, Downloading device upgrade packages and grid codes is supported.

Step 3 Tap **Download** on the screen for downloading the upgrade package.

----End

 **NOTE**

The SUN2000 app uses the ping solar.huawei.com command to check whether the mobile device is connected to the public network. The mobile phone automatically detects software updates when connected to the Internet. If the device upgrade package or grid code is updated, a message is displayed to prompt users to download the upgrade package or grid code. After the inverter is connected, the system prompts you to install the upgrade package. Perform operations as prompted.

8.2 MBUS Whitelist

Prerequisites

- Tools such as the diagonal pliers, grease pen, Android smartphone (with the SUN2000 app installed) are available.
- You have collected SN labels.

NOTICE

- The solar inverter without an LCD allows you to collect and scan the SN bar code.
 - When using diagonal pliers to cut off the SN bar code label suspended under a solar inverter, mark its device name on the back of the label to ensure mapping between the solar inverter name and SN bar code. The SN label position of the SUN2000-33KTL is shown in [Figure 8-3](#), and that of the SUN2000-50KTL is shown in [Figure 8-4](#).
-

Figure 8-2 SN label position on the SUN2000-33KTL

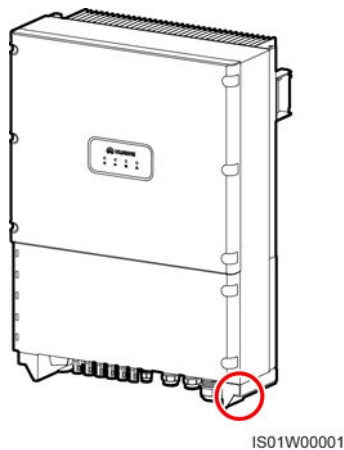
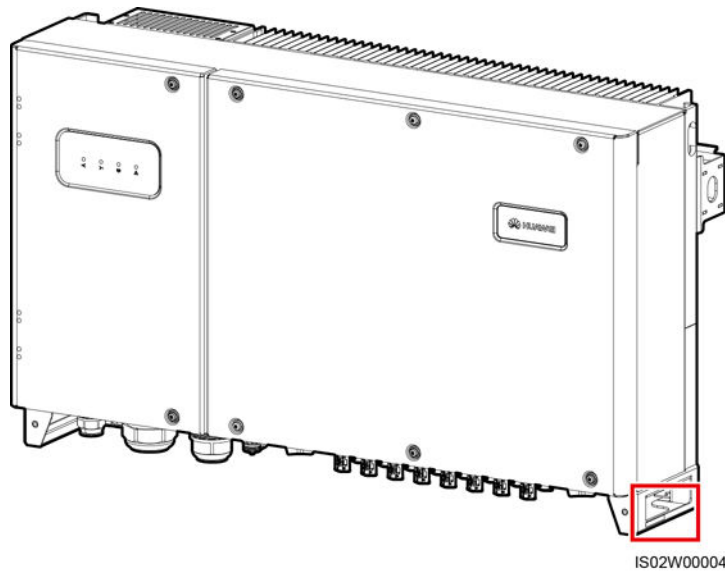

Figure 8-3 SN label position on the SUN2000-50KTL



Context

The SN bar codes of solar inverters are obtained in centralized mode. These bar codes help set up mapping between solar inverter names and SN bar codes on the SmartLogger and assist the SmartLogger to communicate with the solar inverters and commission them.

Procedure

- Step 1** Choose  > **MBUS whitelist** on the app connection screen. On the **MBUS whitelist** screen, enter a user-defined file name and tap **Next**.

Figure 8-4 MBUS whitelist



NOTE

If the SN file already exists, open and scan the file.

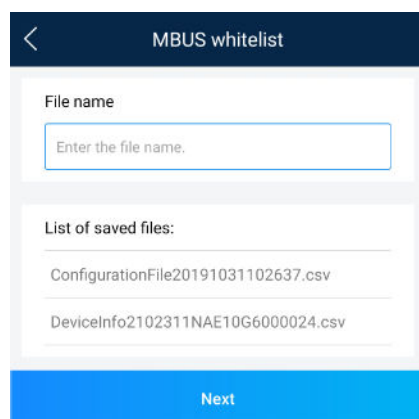
Step 2 On the **SN List** screen, tap **Scan** or **Manual input** to record SN bar codes or QR codes and device names.

Figure 8-5 SN list

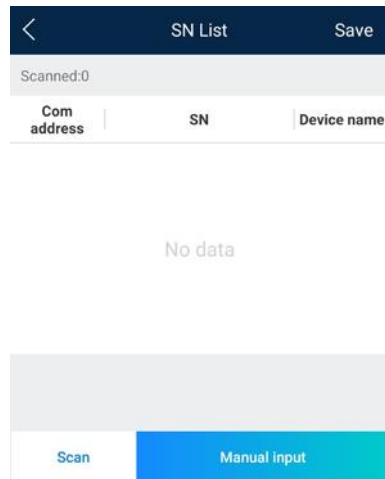

- Method 1: Scan
 - a. Tap **Scan** and specify a scanning mode to start scanning. Ensure that the camera is about 15 cm away from the SN label or QR code.
 - b. After scanning, enter the device number at the back of the scanned label on the **SN Details** screen.
- Method 2: Manual input
 - a. Tap **Manual input**. On the **SN Details** screen, enter the SN bar code and the device name at the back of the label.
 - b. Tap **Confirm** to save the SN information.

 **NOTE**

You can choose  > **MBUS Whitelist** to find the saved SN information file on the list of saved files.

----End

Follow-up Procedure

- After scanning the SN bar code information file, you can choose **More** > **Device List** on the SmartLogger home page to modify the device information.
- Upload the scanned information file to the PC and rename the file as **DeviceInfo.csv**, which provides information when changing the device name and device address on the SmartLogger. For details, see *SmartLogger3000 User Manual*, *SmartLogger2000 User Manual* or *SmartLogger1000A User Manual*.

8.3 Local Maintenance Script

8.3.1 Solar Inverter Maintenance Script

Context

The solar inverter maintenance script is used to set commands for the solar inverter (or PID module). After the script file is copied to the USB flash drive, the solar inverter (or PID module) executes the maintenance script to import or export configuration, export data, and upgrade devices.

NOTE

- The SUN2000-(8KTL-28KTL) does not support the function of generating the solar inverter maintenance script.
- Delete the script file immediately after use to reduce information disclosure risks.

Procedure

Step 1 On the app connection screen, tap  > **Local maintenance script** to access the command setting screen.

Step 2 In the **Local maintenance script** area, select **Inverter/PID**.

Figure 8-6 Inverter command settings

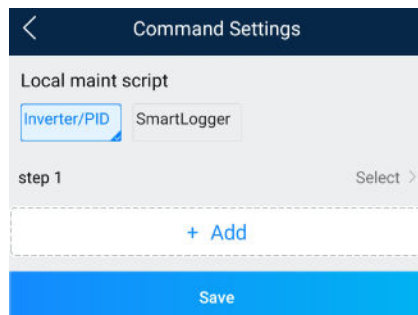

Step 3 Tap **Step 1** and select an operation as required.

Step 4 Tap **Add** to add a step.

Step 5 Repeat **Step 3–Step 4** to finish required operations.

Step 6 Tap **Save**.

Step 7 Enter the user name and password for logging in to the app, and then tap **Confirm** to save the maintenance script in your mobile phone.

NOTE

The name of the maintenance script file is **sun_lmt_mgr_cmd.emap**. You can choose  > **File Manager** > **Device Log** to delete or email the maintenance script.

----End

8.3.2 SmartLogger Maintenance Script

Context

The SmartLogger maintenance script is used to set SmartLogger commands. After the script file is copied to the USB flash drive, the SmartLogger executes the script file to export SmartLogger logs, export or import all files, and upgrade the SmartLogger and BSP.

Procedure

Step 1 On the app connection screen, tap  > **Local maintenance script** to access the command setting screen.

Step 2 Select **SmartLogger** for **Local maintenance script**.

Figure 8-7 SmartLogger command settings

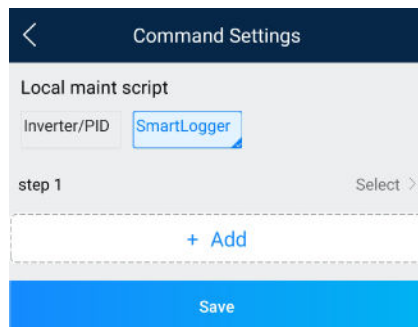

Step 3 Tap **Step 1** and select an operation as required.

Step 4 Tap **Add** to add a step.

Step 5 Repeat [Step 3](#)–[Step 4](#) to finish required operations.

Step 6 Tap **Save**.

Step 7 Enter the user name and password for logging in to the app, and then tap **Confirm** to save the maintenance script in your mobile phone.

NOTE

The name of the maintenance script file is **logger_lmt_mgr_cmd.emap**. You can choose  > **File Manager** > **Device Log** to delete or email the maintenance script.

----End

Follow-up Procedure

You can also log in to the app as an advanced user or a special user and choose **More** > **System Maintenance** > **SmartLogger Command Set** on the **Home** screen of the SmartLogger to set the parameters.

8.4 File Management

Context

The file management function manages app operation logs, device logs, and generated script files and configuration files. You can delete the logs and files, send them to your mailbox, or export them using a Mac.

Procedure

Step 1 On the app connection screen, tap  > **File manager** to access the **File manager** screen.

Step 2 On the **File manager** screen, the downloaded log files, generated scripts, and configuration files are displayed.

Step 3 To delete files, select one or more files and tap **Delete**.

Step 4 To send files to your mailbox, select one or more files and tap **Share**.

Step 5 Download app logs.

1. On the **File manager** screen, tap **Download** in the upper right corner. The **Download logs** screen is displayed.
2. Select **APP log** and tap **Download**.

After the logs are downloaded, you can tap **Share** to send the logs to your mailbox.

----End

8.5 About

Context

This screen is used to query the app version information, technical support website, privacy policy (displayed only on the SUN2000 app), customer service contact information, and open source software policy.

NOTE

- When the app starts for the first time after being downloaded or updated, the privacy policy is displayed. You can use the app only after agreeing to the privacy policy, and the privacy policy will no longer appear. If you do not agree to the privacy policy, the app exits, and the privacy policy is still displayed when you start the app next time until you agree to the privacy policy.
- You can revoke the agreed privacy policy.

Procedure

Step 1 On the app connection screen, tap  > **About** to view the app version information and technical support website.

Figure 8-8 About



Step 2 Tap **Privacy policy** or **Open source software policy** to view the privacy policy and open source software policy.

----End

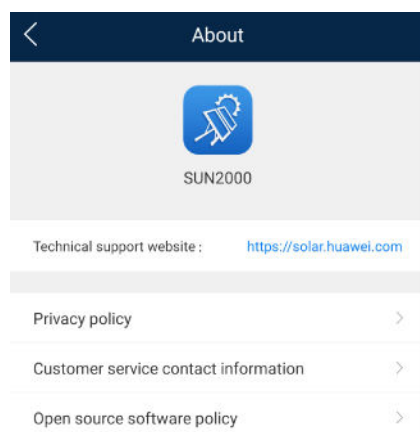
9 Troubleshooting

Table 9-1 Troubleshooting

No.	Symptom	Possible Cause	Solution
1	The app fails to be installed.	<ul style="list-style-type: none"> The version of the mobile phone operating system is earlier than the required version. Allow Installation of apps from unknown sources is not selected. 	<ul style="list-style-type: none"> Upgrade the version of the mobile phone operating system. Choose Settings > Security and select Allow Installation of apps from unknown sources.
2	Communication failed.	<ol style="list-style-type: none"> When the mobile phone is more than 5 m away from the devices, the Bluetooth module is disconnected. The USB data cable is incorrectly connected. The mobile phone or router is more than 5 meters away from the solar inverter, so the WiFi connection is disconnected. 	<ol style="list-style-type: none"> Keep the mobile phone within 5 m away from the devices and reconnect the Bluetooth module. Reconnect the USB data cable. Keep the mobile phone or router within 5 meters of the solar inverter and reconnect the WiFi connection.
3	The solar inverter cannot be obtained.	An error occurs in the WiFi connection to the app.	<ul style="list-style-type: none"> If the solar inverter still cannot be obtained after several attempts, log out and try again. Check whether the WiFi connection is correct.
4	The message Failed to connect to the Bluetooth. Try to connect to	<ul style="list-style-type: none"> The Bluetooth module is abnormal. The Bluetooth module is used. 	<ul style="list-style-type: none"> Verify that the Bluetooth module works properly. Verify that the Bluetooth module is not used.

No.	Symptom	Possible Cause	Solution
	the system Bluetooth. is displayed.		
5	The message Enable Bluetooth connection. is displayed.	The Bluetooth function is not enabled.	Enable the Bluetooth function.
6	The message Failed to identify the device. Check whether the device is correctly connected. is displayed.	<ul style="list-style-type: none"> The WLAN module is abnormal. The WLAN module is used 	<ul style="list-style-type: none"> Verify that the WLAN module works properly. Verify that the WLAN module is not used
7	The message Failed to connect to the inverter. Please reconnect it. is displayed.	The mobile phone or router is more than 5 meters away from the solar inverter, or the WiFi signal is weak.	Ensure that the WiFi network is connected. Log out of the app and then log in again.
8	Data failed to be obtained during operations.	<ol style="list-style-type: none"> The Bluetooth module is abnormal. The USB data cable is incorrectly connected. Connection to the solar inverter is disconnected. 	<ol style="list-style-type: none"> Reseat the Bluetooth module. Reconnect the USB data cable. Connect to the solar inverter again.
9	The MBUS scanning function cannot be used.	The app does not have the permission to use the camera.	Enable the app to use the camera.
10	The label information cannot be identified when the MBUS scanning function is being used.	<ul style="list-style-type: none"> The scan position is incorrect, or the camera is too far away from the bar code. The light is insufficient. The label is blocked. 	<ul style="list-style-type: none"> Adjust the scan position and ensure that the camera is 15 cm away from the label. Move the label to a place with sufficient light. Remove the blockage from the label.
11	No upgrade package is available for an upgrade.	No upgrade package is saved in the mobile phone.	Save the upgrade package in the mobile phone.
12	The battery of the mobile phone is too low.	N/A	Charge the mobile phone.
13	When you set parameters on the	<ol style="list-style-type: none"> When you go to the Add Plant screen, the 	Connect your phone to an available network.

No.	Symptom	Possible Cause	Solution
	local commissioning tool and go to the Add Plant screen by following Setup Wizard , a message is displayed indicating that the network is abnormal.	mobile phone is connected to the solar inverter WiFi but not to an available network. 2. When you go to the Add Plant screen, the mobile phone is not connected to any network.	
14	The user fails to locate the position on the map.	1. The GPS or network signal of the mobile phone is poor. 2. The GPS function is not enabled on the phone.	1. You need to locate the position at a place with good network quality or with strong GPS signals. 2. Enable the GPS function on the phone.

10 FAQs

10.1 1.1 How Do I Use a Phone to Scan the QR Code to Download the FusionSolar App

Method 1: Use the camera on your phone to scan the QR code.



- For an iPhone:
 - a. Choose **Settings** > **Control Center** > **Customize Controls**.
 - b. Check whether **Scan QR Code** is included in the additional controls in **Control Center**.
 - If yes, go to c.
 - If no, tap  on the left of **Scan QR Code**.
 - c. Swipe up from the bottom of the screen to display the Control Center, and then tap the **Scan QR Code** icon.

Figure 10-1 Control Center

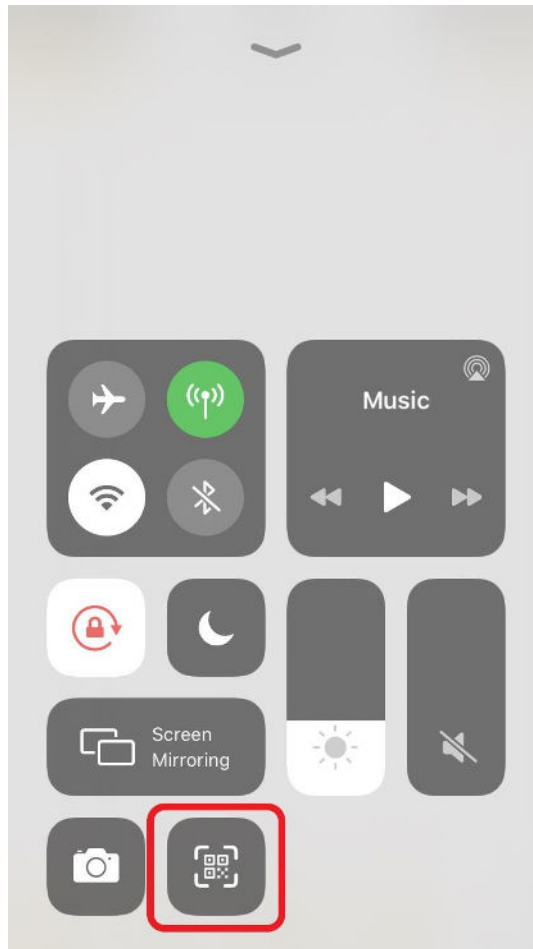

- d. Align the camera with the QR code you want to scan, and follow the onscreen instructions to download and install the FusionSolar app.
- For a Samsung phone:
 - a. Open **Camera** and tap  in the upper-right corner.
 - b. Enable **Scan QR codes**.
 - c. Tap  to return to the camera screen, align the camera with the QR code you want to scan, and follow the onscreen instructions to download and install the FusionSolar app.

 **NOTE**

- The screen varies according to the phone model. The actual screen prevails.
- If your phone's camera does not support QR code scanning, you are advised to use method 2 to scan the QR code using the browser on your phone.

Method 2: Use the code scanning program of the mobile browser (Huawei browser, Opera, or Edge is recommended). This section uses Huawei browser as an example.

1. Open the browser and tap the QR code scanning or photographing icon on the right of the search box.

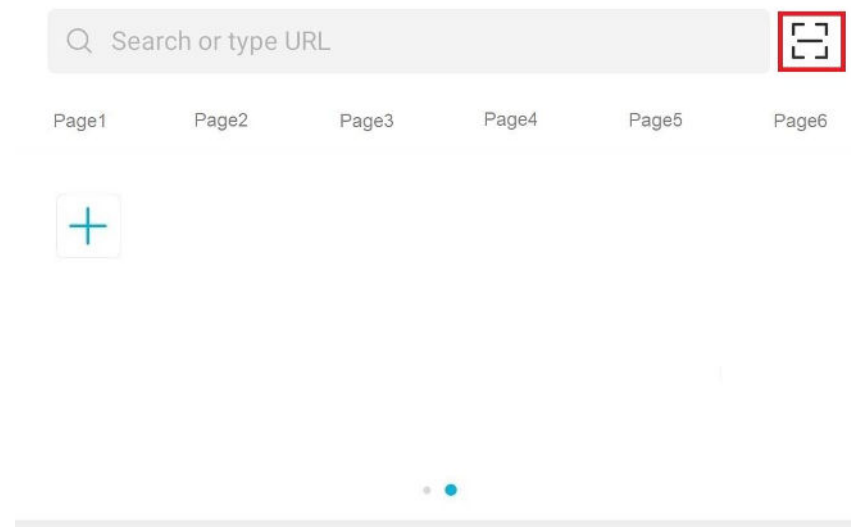

2. Align the camera with the QR code you want to scan, and follow the onscreen instructions to download and install the FusionSolar app.

 **NOTE**

The screen varies according to the browser brand. The actual screen prevails.

Some browsers may not support app download. If the FusionSolar app cannot be downloaded after the QR code is identified, you are advised to use a recommended browser.

10.2 Setting the Email on the Mobile Phone

Procedure

- Step 1** Find and tap **Email** on the phone.

Figure 10-2 Home screen of the phone

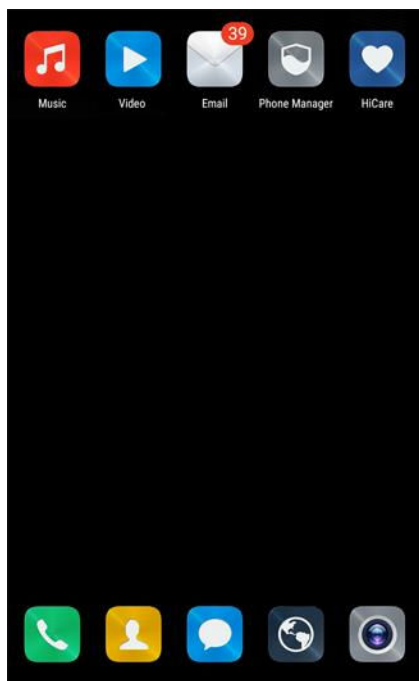

Step 2 Choose your email service provider from the list. If it is on the list already, directly choose it. If not, choose **Other** on the list.

Figure 10-3 Adding an account

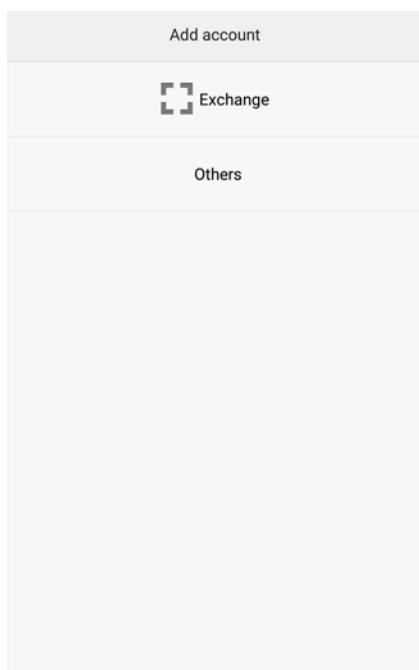

Step 3 Specify the correct email address and password. Tap **Next** to authenticate.

Figure 10-4 Setting the account

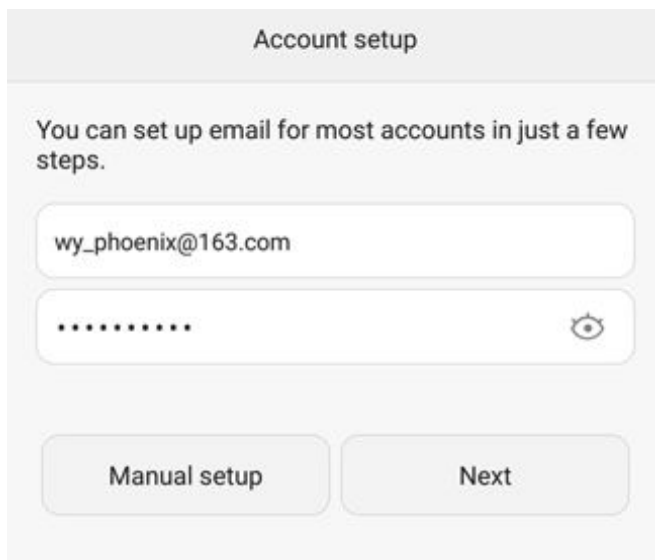

Step 4 If **Account setup error** is displayed, confirm it and choose **Manual setup**.

Figure 10-5 Manually setting an account

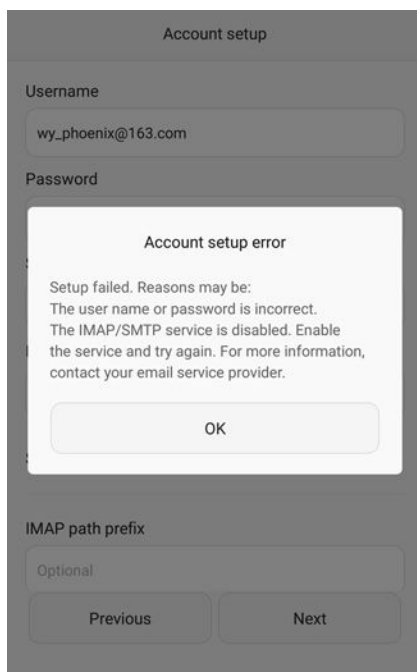

Step 5 Choose the protocol type of the email server (POP3 by default).

Figure 10-6 Setting the account type

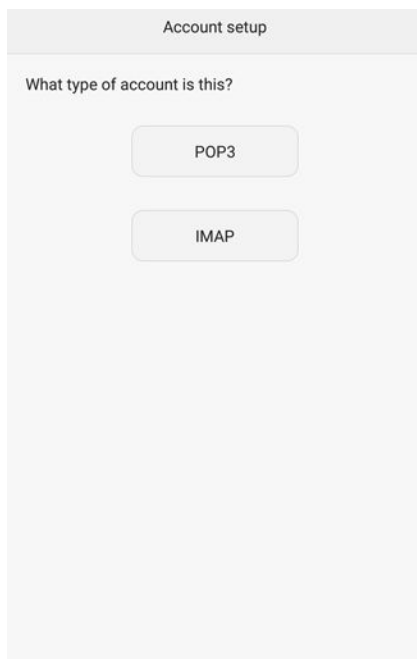

Step 6 After the configuration is completed, you can set the sending and receiving options of the email account.

Figure 10-7 Setting the sending and receiving options

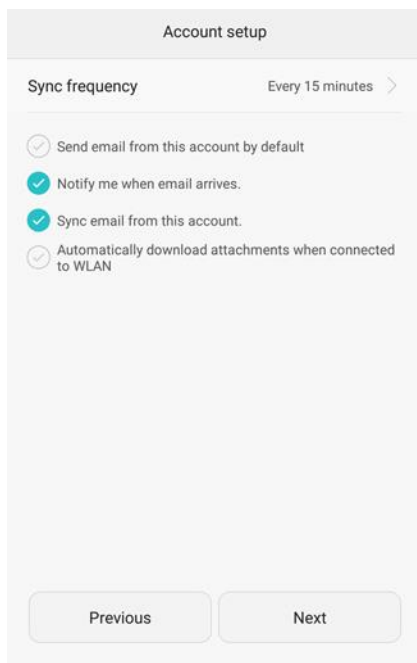

Step 7 Tap **Next** to enter the mailbox. If you can receive and send emails, the email function of the SUN2000 APP is successfully enabled.

NOTE

The phone mailbox configuration interface will be different depending on the phone model. The actual mobile phone interface is subject to change.

----End

10.3 Changing the App Login Password

Procedure

Step 1 In the upper-right corner of the home screen, choose  > **Change password** to change the password.

Figure 10-8 Changing the password



Step 2 Specify **Old password**, **New password**, and **Confirm password**, and then tap **Confirm**.

NOTE

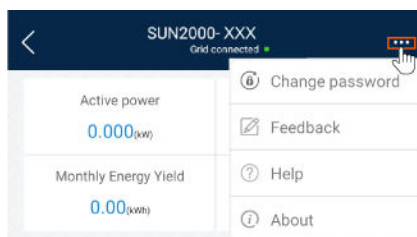
The password must meet the following requirements:

- Contains six characters.
- Contains at least two of the three types: lowercase letters, uppercase letters, and digits.

----End

10.4 How Do I Set a User-Defined Grid Code

Context

If the national grid code of the solar inverter is not in the list, you can customize a grid code.

Procedure

Step 1 On the home screen, choose **Settings** > **Grid Parameters** to access the parameter setting screen.

Step 2 In the grid code drop-down list, tap **Custom** to deliver the settings to the device.

Table 10-1 User-defined grid code

User-defined Grid Code	Default Output Mode	Phase Voltage Level Vn(V)	Line Voltage Level Vn(V)	Frequency Level Fn(Hz)
Custom(50Hz)	Three-phase four-wire	230	400	50
Custom(60Hz)	Three-phase four-wire	230	400	60
Custom-MV480(50Hz)	Three-phase three-wire	277	480	50
Custom-MV480(60Hz)	Three-phase three-wire	277	480	60

 **NOTE**

Select a user-defined grid code (**Custom**) based on the voltage and frequency of the local power grid system.

Step 3 Set the power grid, protection, feature, or power adjustment parameters on the **Settings** screen based on the local power grid requirements.

For details about the parameter settings for commercial solar inverters, see [A Commercial Smart Inverters Parameters](#).

For details about the parameter settings for distributed solar inverters, see [4.7 Settings](#).

----End

10.5 How Do I Fix WLAN Connection Failure

Symptom	Possible Cause	Suggestion
WLAN connection failure	The WLAN network is not allowed.	Forget the WLAN network from the WLAN list in the phone system and reconnect to the network. The screen varies depending on the phone model.
	You have entered an incorrect WLAN password.	Forget the WLAN network from the WLAN list in the phone system and reconnect to the network using the correct password. The screen varies depending on the phone model.
	The WLAN network is being used by another phone.	Wait for the other phone to exit or restart the WLAN network.
	The WLAN hotspot is automatically disabled because it is not used for a long time after	Restart the WLAN network and search again.

Symptom	Possible Cause	Suggestion
	connection.	
	If the This WLAN network has no Internet access. Connect anyway? message is displayed when you connect to the built-in WLAN, tap CANCEL .	Forget the WLAN network from the WLAN list in the phone system and reconnect to the network. When this message is displayed when you connect to the built-in WLAN, tap CONNECT . The screen varies depending on the phone model.

 **NOTE**

If you cannot rectify faults with the measures listed in the "Suggestion" column, contact your dealer or Huawei technical support.

10.6 IPS Check (for Italy CEI0-21 Grid Code Only)

Function

The Italy CEI0-21 grid code requires an IPS check for the SUN2000. During the self-check, the SUN2000 checks the protection threshold and protection time of the maximum voltage over 10 min (59.S1), maximum overvoltage (59.S2), minimum undervoltage (27.S1), minimum undervoltage (27.S2), maximum overfrequency (81.S1), maximum overfrequency (81.S2), minimum underfrequency (81.S), and minimum underfrequency (81.S2).

Procedure

- Step 1** On the home screen, choose **Maintenance > IPS test** to access the IPS test screen.
- Step 2** Tap **Start** to start an IPS test. The SUN2000 detects maximum voltage over 10 min (59.S1), maximum overvoltage (59.S2), minimum undervoltage (27.S1), minimum undervoltage (27.S2), maximum overfrequency (81.S1), maximum overfrequency (81.S2), and minimum underfrequency (81.S1), and minimum underfrequency (81.S2).

Figure 10-9 IPS test

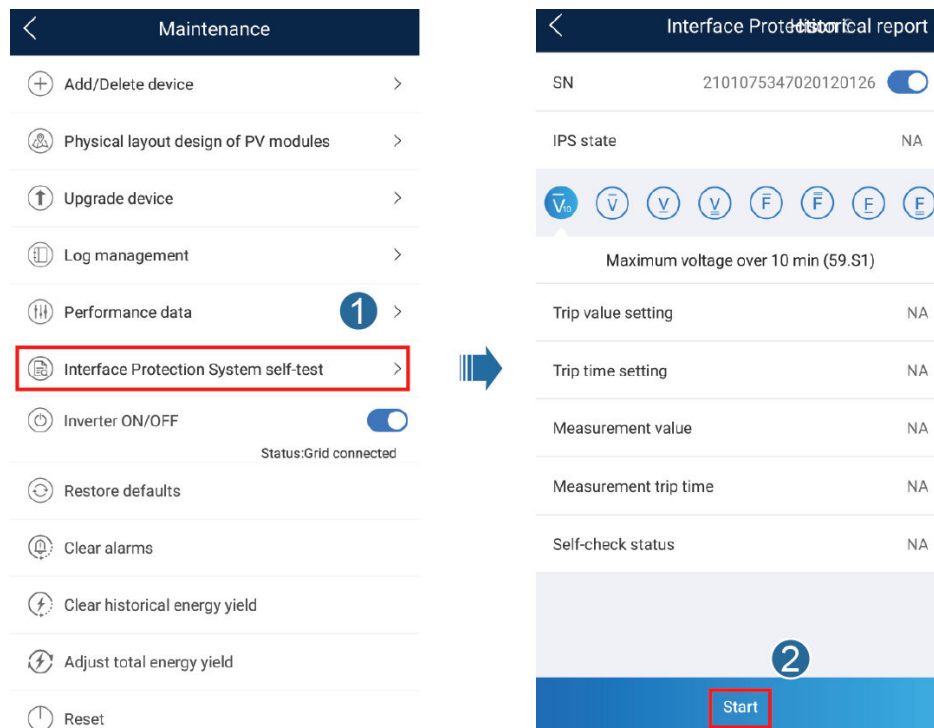

Table 10-2 IPS test type

IPS Test Type	Description
Maximum voltage over 10 min (59.S1)	The default maximum voltage over 10 min protection threshold is 253 V (1.10 V _n), and the default protection time threshold is 3s.
Maximum overvoltage (59.S2)	The default overvoltage protection threshold is 264.5 V (1.15 V _n), and the default protection time threshold is 0.2s.
Minimum undervoltage (27.S1)	The default undervoltage protection threshold is 195.5 V (0.85 V _n), and the default protection time threshold is 1.5s.
Minimum undervoltage (27.S2)	The default undervoltage protection threshold is 34.5 V (0.15 V _n), and the default protection time threshold is 0.2s.
Maximum overfrequency (81.S1)	The default overfrequency protection threshold is 50.2 Hz, and the default protection time threshold is 0.1s.
Maximum overfrequency (81.S2)	The default overfrequency protection threshold is 51.5 Hz, and the default protection time threshold is 0.1s.
Minimum underfrequency (81.S1)	The default underfrequency protection threshold is 49.8 Hz, and the default protection time threshold is 0.1s.

IPS Test Type	Description
Minimum underfrequency (81.S2)	The default underfrequency protection threshold is 47.5 Hz, and the default protection time threshold is 0.1s.

Step 3 After the IPS test is complete, **IPS State** is displayed as **IPS state success**. Tap **Historical report** in the upper right corner of the screen to view the IPS check report.

----End

10.7 How Do I Import a Grid Code?

Procedure

Step 1 On the home screen, choose **Settings > Grid parameters**. The **Grid parameters** screen is displayed.

Step 2 Tap **Grid code** and tap  to import the grid code file.

----End

10.8 How Do I Change the SSID and Password of the SmartLogger Built-in WLAN?

Step 1 On the home screen, choose **More > Settings > Device WLAN hotspot**. The **Device WLAN hotspot** screen is displayed.

Step 2 Change the SSID and password of the built-in WLAN.

Table 10-3

Parameter	Description
SSID	<ul style="list-style-type: none"> Specifies the name of the built-in WLAN. The default name of the built-in WLAN is Logger_SN.
Password	<ul style="list-style-type: none"> Specifies the password for accessing the built-in WLAN. The initial password of the built-in WLAN is Changeme. Use the initial password upon first power-on and change it immediately after login. To ensure account security, change the password periodically and keep the new password in mind. Not

Parameter	Description
	changing the initial password may cause password disclosure. A password left unchanged for a long period of time may be stolen or cracked. If a password is lost, the device needs to be restored to factory settings. In these cases, the user is liable for any loss caused to the PV plant.

----End

10.9 What Can I Do If My Phone Fails to Connect to a WLAN After I Scan the QR Code?

Symptom

After the device QR code is scanned using a smartphone, the **Device to use with** message is displayed. After **CONNECT** is tapped three times, the **The WLAN connection has changed. Try to connect to the system WLAN** message is displayed.

Solution

- For Huawei mobile phones on Android 10 or later:
 - a. On the home screen of your mobile phone, tap **Settings** > **WLAN**.
 - b. Tap **More settings**.
 - c. Disable **WLAN+**.
- For other mobile phones:
 - a. On the home screen of your mobile phone, tap **Settings** > **WLAN**.
 - b. Tap the **WLAN** of the target device, select **FORGET** or **DELETE**, and scan the QR code to connect to the **WLAN** again.

NOTE

If the **This WLAN network has no Internet access. Connect anyway?** message is displayed when you connect to the built-in **WLAN**, tap **CONNECT**. Otherwise, you cannot log in to the system. The actual UI and messages may vary with mobile phones.

A Commercial Smart Inverters Parameters

A.1 Grid parameters

A.1.1 Advanced User

No.	Parameter	Description
1	Grid Code	Set this parameter based on the grid code of the country or region where the inverter is used and the inverter application scenario.
2	Isolation settings	Set the working mode of the inverter based on the grounding status at DC side and the connection to the power grid.

A.1.2 Special User

No.	Parameter	Description
1	Grid Code	Set this parameter based on the grid code of the country or region where the inverter is used and the inverter application scenario.
2	Isolation settings	Set the working mode of the inverter based on the grounding status at DC side and the connection to the power grid.
3	Output mode	Specifies whether the inverter output has a neutral wire based on the application scenario.
4	PQ mode	If this parameter is set to PQ mode 1 , the maximum AC output power equals the maximum apparent power. If this parameter is set to PQ mode 2 , the maximum AC output power equals the rated output power.
5	Automatically start upon grid recovery	Specifies whether to allow the inverter to automatically start after the power grid recovers.
6	Grid connected recovery time	Specifies the time after which the inverter begins restarting after the power grid recovers.

No.	Parameter	Description
	from grid faults (s)	
7	Startup voltage lower threshold of grid connection (V)	According to the standards of certain countries and regions, after the inverter is powered on for the first time for grid connection, if the power grid voltage is lower than Startup voltage lower threshold of grid connection , the inverter is not allowed to connect to the grid.
8	Startup frequency upper threshold of grid connection (Hz)	According to the standards of certain countries and regions, after the inverter is powered on for the first time for grid connection, if the power grid voltage is higher than Startup frequency upper threshold of grid connection , the inverter is not allowed to connect to the grid.
9	Startup frequency lower threshold of grid connection (Hz)	According to the standards of certain countries and regions, after the inverter is powered on for the first time for grid connection, if the power grid voltage is lower than Startup frequency lower threshold of grid connection , the inverter is not allowed to connect to the grid.
10	Grid reconnection voltage upper limit (V)	The standards of certain countries and regions require that after the inverter shuts down for protection due to a fault, if the power grid voltage is higher than Grid reconnection voltage upper limit , the inverter is not allowed to reconnect to the grid.
11	Grid reconnection voltage lower limit (V)	The standards of certain countries and regions require that after the inverter shuts down for protection due to a fault, if the power grid voltage is lower than Grid reconnection voltage lower limit , the inverter is not allowed to reconnect to the grid.
12	Grid reconnection frequency upper limit (Hz)	The standards of certain countries and regions require that after the inverter shuts down for protection due to a fault, if the power grid frequency is higher than Grid reconnection frequency upper limit , the inverter is not allowed to reconnect to the grid.
13	Grid reconnection frequency lower limit (Hz)	The standards of certain countries and regions require that after the inverter shuts down for protection due to a fault, if the power grid frequency is lower than Grid reconnection frequency lower limit , the inverter is not allowed to reconnect to the grid.
14	Reactive power compensation (cosφ-P) trigger voltage (%)	Specifies the voltage threshold for triggering reactive power compensation based on the cosφ-P curve.
15	Reactive power compensation (cosφ-P) exit voltage (%)	Specifies the voltage threshold for exiting reactive power compensation based on the cosφ-P curve.

A.2 Protection Parameters

A.2.1 Advanced User

No.	Parameter	Description
1	Insulation resistance protection threshold (MΩ)	To ensure device safety, the inverter detects the insulation resistance of the input side with respect to ground when it starts a self-check. If the detected value is less than the preset value, the inverter does not connect to the grid.

A.2.2 Special User

No.	Parameter	Description
1	Voltage unbalance protection threshold (%)	Specifies the inverter protection threshold when the power grid voltage is unbalanced.
2	Phase protection point (°)	The Japanese standard requires that during passive islanding detection, protection should be triggered if an abrupt voltage phase change is detected.
3	Phase angle offset protection	The standards of certain countries and regions require that the inverter needs to be protected when the phase angle offset of the power grid three phases exceeds a certain value.
4	10-min overvoltage protection threshold (V)	Specifies the 10-minute overvoltage protection threshold.
5	10-min overvoltage protection duration (ms)	Specifies the 10-minute overvoltage protection duration.
6	Level-1 overvoltage protection threshold (V)	Specifies the level-1 overvoltage protection threshold.
7	Level-1 overvoltage protection duration (ms)	Specifies the level-1 overvoltage protection duration.
8	Level-2 overvoltage protection threshold (V)	Specifies the level-2 overvoltage protection threshold.
9	Level-2 overvoltage protection duration (ms)	Specifies the level-2 overvoltage protection duration.
10	Level-3 overvoltage protection threshold (V)	Specifies the level-3 overvoltage protection threshold.
11	Level-3 overvoltage protection duration (ms)	Specifies the level-3 overvoltage protection duration.
12	Level-4 overvoltage protection threshold (V)	Specifies the level-4 overvoltage protection threshold.
13	Level-4 overvoltage protection duration (ms)	Specifies the level-4 overvoltage protection duration.

No.	Parameter	Description
14	Level-5 overvoltage protection threshold (V)	Specifies the level-5 overvoltage protection threshold.
15	Level-5 overvoltage protection duration (ms)	Specifies the level-5 overvoltage protection duration.
16	Level-6 overvoltage protection threshold (V)	Specifies the level-6 overvoltage protection threshold.
17	Level-6 overvoltage protection duration (ms)	Specifies the level-6 overvoltage protection duration.
18	Level-1 undervoltage protection threshold (V)	Specifies the level-1 undervoltage protection threshold.
19	Level-1 undervoltage protection duration (ms)	Specifies the level-1 undervoltage protection duration.
20	Level-2 undervoltage protection threshold (V)	Specifies the level-2 undervoltage protection threshold.
21	Level-2 undervoltage protection duration (ms)	Specifies the level-2 undervoltage protection duration.
22	Level-3 undervoltage protection threshold (V)	Specifies the level-3 undervoltage protection threshold.
23	Level-3 undervoltage protection duration (ms)	Specifies the level-3 undervoltage protection duration.
24	Level-4 undervoltage protection threshold (V)	Specifies the level-4 undervoltage protection threshold.
24	Level-4 undervoltage protection duration (ms)	Specifies the level-4 undervoltage protection duration.
26	Level-5 undervoltage protection threshold (V)	Specifies the level-5 undervoltage protection threshold.
27	Level-5 undervoltage protection duration (ms)	Specifies the level-5 undervoltage protection duration.
28	Level-6 undervoltage protection threshold (V)	Specifies the level-6 undervoltage protection threshold.
29	Level-6 undervoltage protection duration (ms)	Specifies the level-6 undervoltage protection duration.
30	Level-1 overfrequency protection threshold (Hz)	Specifies the level-1 overfrequency protection threshold.
31	Level-1 overfrequency protection duration (ms)	Specifies the level-1 overfrequency protection duration.
32	Level-2 overfrequency protection threshold (Hz)	Specifies the level-2 overfrequency protection threshold.
33	Level-2 overfrequency protection	Specifies the level-2 overfrequency protection duration.

No.	Parameter	Description
	duration (ms)	
34	Level-3 overfrequency protection threshold (Hz)	Specifies the level-3 overfrequency protection threshold.
35	Level-3 overfrequency protection duration (ms)	Specifies the level-3 overfrequency protection duration.
36	Level-4 overfrequency protection threshold (Hz)	Specifies the level-4 overfrequency protection threshold.
37	Level-4 overfrequency protection duration (ms)	Specifies the level-4 overfrequency protection duration.
38	Level-5 overfrequency protection threshold (Hz)	Specifies the level-5 overfrequency protection threshold.
39	Level-5 overfrequency protection duration (ms)	Specifies the level-5 overfrequency protection duration.
40	Level-6 overfrequency protection threshold (Hz)	Specifies the level-6 overfrequency protection threshold.
41	Level-6 overfrequency protection duration (ms)	Specifies the level-6 overfrequency protection duration.
42	Level-1 underfrequency protection threshold (Hz)	Specifies the level-1 underfrequency protection threshold.
43	Level-1 underfrequency protection duration (ms)	Specifies the level-1 underfrequency protection duration.
44	Level-2 underfrequency protection threshold (Hz)	Specifies the level-2 underfrequency protection threshold.
45	Level-2 underfrequency protection duration (ms)	Specifies the level-2 underfrequency protection duration.
46	Level-3 underfrequency protection threshold (Hz)	Specifies the level-3 underfrequency protection threshold.
47	Level-3 underfrequency protection duration (ms)	Specifies the level-3 underfrequency protection duration.
48	Level-4 underfrequency protection threshold (Hz)	Specifies the level-4 underfrequency protection threshold.
49	Level-4 underfrequency protection duration (ms)	Specifies the level-4 underfrequency protection duration.
50	Level-5 underfrequency protection threshold (Hz)	Specifies the level-5 underfrequency protection threshold.
51	Level-5 underfrequency protection duration (ms)	Specifies the level-5 underfrequency protection duration.
52	Level-6 underfrequency protection threshold (Hz)	Specifies the level-6 underfrequency protection threshold.

No.	Parameter	Description
53	Level-6 underfrequency protection duration (ms)	Specifies the level-6 underfrequency protection duration.

A.3 Feature parameters

A.3.1 Advanced User

No.	Parameter	Description	Remarks
1	MPPT multi-peak scanning	When the inverter is used in scenarios where PV strings are greatly shaded, set this parameter to Enable , and then the inverter will perform MPPT scanning at regular intervals to locate the maximum power.	-
2	MPPT multi-peak scan interval (min)	Specifies the MPPT scanning interval.	This parameter is displayed when MPPT multi-peak scanning is set to Enable .
3	RCD enhancement	RCD refers to the residual current of the inverter to the ground. To ensure device and personal safety, RCD should be limited to the specified value in the standard. If an AC switch with a residual current detection function is installed outside the inverter, this function should be enabled to reduce the residual current generated when the inverter is running, thereby preventing the AC switch from misoperations.	-
4	Night-time reactive power output	In some specific application scenarios, a power grid company requires that the inverter can perform reactive power compensation at night to ensure that the power factor of the local power grid meets requirements.	This parameter is displayed when Isolation settings is set to Input ungrounded, with TF .
5	PID protection at night	When the inverter outputs reactive power at night and this parameter is set to Enable , the inverter will shut down automatically if it detects abnormal status of the PID compensation.	-
6	Strong adaptability	If the power grid short-circuit capacity or PV plant installed capacity is less than 3, the power grid quality will be affected if the power grid impedance is too high, which may cause the inverter to malfunction. In this case, if the inverter is required to work properly, set this parameter to Enable .	-

No.	Parameter	Description	Remarks
7	Power quality optimization mode	If this parameter is set to Enable , the inverter output current harmonics will be optimized.	-
8	PV module type	This parameter is used to set different types of PV modules and the shutdown time of the concentration PV module. If the concentration PV modules are shaded, the power drops drastically to 0 and the inverter shuts down. The energy yield would be affected since it takes too long for the power to resume and inverter to restart. The parameter does not need to be set for crystalline silicon and filmy PV modules.	<ul style="list-style-type: none"> • If this parameter is set to Crystalline silicon or Film, the inverter automatically detects the power of PV modules when they are shaded and shuts down if the power is too low. • When concentration PV modules are used: <ul style="list-style-type: none"> - If this parameter is set to CPV 1, the inverter can quickly restart in 60 minutes if the input power of PV modules drops drastically due to shading. - If this parameter is set to CPV 2, the inverter can quickly restart in 10 minutes if the input power of PV modules drops drastically due to shading.
9	Built-in PID compensation direction	When the external PID module compensates the PID voltage for the PV system, set Built-in PID compensation direction to the actual compensation direction of the PID module so that the inverter can output reactive power at night.	This parameter is displayed when PV module type is set to Crystalline silicon . Select PV- positive offset for P-type PV modules. Select PV+ negative offset for N-type PV modules.
10	PID running mode	Specifies the operation mode of the inverter built-in PID.	-
11	PID nighttime off-grid repair	Specifies whether to enable the PID nighttime off-grid repair.	If PID running mode is not set to Disable , the parameter can be set.
12	PID daytime off-grid repair	Specifies whether to enable the PID daytime off-grid repair.	
13	String connection mode	Specifies the connection mode of PV strings.	<ul style="list-style-type: none"> • When PV strings connect to the inverter separately (All PV strings separated), there is no need to set this parameter. The inverter can automatically detect the connection mode of the PV strings. • When PV strings connect to one another in parallel outside the inverter and then connect

No.	Parameter	Description	Remarks
			to it independently (All PV strings connected), set this parameter to All PV strings connected .
14	Automatic OFF due to communication interrupted	The standards of certain countries and regions require that the inverter must shut down after the communication is interrupted for a certain time.	If Automatic OFF due to communication interrupted is set to Enable and the inverter communication is interrupted for a specified time (set by Communication interruption duration), the inverter will automatically shut down.
15	Communication interruption duration (min)	Specifies the duration for determining communication interruption. Used for automatic shutdown for protection in case of communication interruption.	-
16	Automatic ON due to communication resumed	If this parameter is set to Enable , the inverter automatically starts after communication recovers. If this parameter is set to Disable , the inverter needs to be started manually after communication recovers.	This parameter is displayed when Automatic OFF due to communication interrupted is set to Enable .
17	Soft start/boot time (s)	Specifies the duration for the power to gradually increase when the inverter starts.	-
18	Shutdown gradient (%/s)	Specifies the power change speed when the inverter shuts down.	-
19	AFCI	The North American standard requires that the inverter should have DC arc detection function.	-
20	AFCI detection adaptive mode	Adjusts the sensitivity of arc detection.	This parameter is displayed only when AFCI is set to Enable .
21	AFCI self-test	Send the AFCI self-check command manually.	-
22	Current error during the scan (A)	To prevent inaccurate scanning caused by sunlight change, the current change of PV strings operating properly should be monitored when the I-V curves of PV strings are being scanned. When the current exceeds the specified value, it is determined that the sunlight changes. The I-V curves should be scanned again.	-
23	OVGR associated shutdown	If this parameter is set to Enable , the inverter shuts down after receiving the OVGR signal. If this parameter is set to Disable , the inverter does not shut down after receiving the OVGR signal.	This parameter is displayed if the Japanese grid code is selected.

No.	Parameter	Description	Remarks
24	Dry contact function	Identifies the dry contact signals from the SmartLogger.	Set this parameter to OVGR for OVGR signals, and set it to NC for other signals. This parameter is displayed if the Japanese grid code is selected.
25	Commanded shutdown hold after power recovery	The standards of certain countries and regions require that if the inverter is shut down after receiving a command and powered on again after power recovers, it should still be in commanded shutdown state.	-
26	Night-time hibernation	The inverter monitors PV strings at night. If this parameter is set to Enable , the monitoring function of the inverter will hibernate at night to reduce power consumption.	-
27	MBUS communication	For inverters that support RS485 communication and MBUS communication, you are advised to set this parameter to Disable to reduce power consumption.	-
28	RS485-2 communication	If this parameter is set to Enable , the RS485-2 port can be used. If the port is not used, you are advised to set this parameter to Disable to reduce power consumption.	-
29	Delay upgrade	This parameter is mainly used in the upgrade scenarios where the PV power supply is disconnected at night due to no sunlight or unstable at dawn or dusk due to poor sunlight.	After the inverter starts to upgrade, if Delay upgrade is set to Enable , the upgrade package is loaded first. After the PV power supply recovers and the activation conditions are met, the inverter automatically activates the upgrade.
30	String monitor	The inverter monitors PV strings in real time. If any PV string is abnormal (such as the PV string is shaded or the electric energy yield decreases), the inverter generates an alarm to remind maintenance personnel to maintain the PV string in a timely manner.	If PV strings are often shaded, you are advised to set String monitor to Disable to prevent false alarms.
31	String detection low power delay (min)	Specifies the delay time for generating abnormal string alarms when the inverter detects that a PV string is working with low power. This parameter is mainly used in the scenario where PV strings are shaded for a long time in the morning and evening, and is used to prevent false alarms.	This parameter is displayed when String monitor is set to Enable .

No.	Parameter	Description	Remarks
32	String detection high power delay (min)	Specifies the delay time for generating abnormal string alarms when the inverter detects that a PV string is working with high power.	
33	String detection power segment division percentage (%)	Specifies the thresholds for determining whether a PV string is working with high power or low power. This parameter is used to distinguish the working status of PV strings.	
34	String detection reference asymmetric coefficient	Specifies the threshold for determining PV string exception. The false alarms caused by fixed shadow shading can be controlled by changing this parameter.	
35	String detection starting power percentage (%)	Specifies the threshold for starting PV string exception detection. The false alarms caused by fixed shadow shading can be controlled by changing this parameter.	
36	OFF at 0% power limit	If this parameter is set to Enable , the inverter shuts down after receiving the 0% power limit command. If this parameter is set to Disable , the inverter does not shut down after receiving the 0% power limit command.	-
37	Maximum apparent power (kVA)	Specifies the output upper threshold for the maximum apparent power to adapt to the capacity requirements of standard and customized inverters.	If the maximum active power equals the value of Smax_limit, this parameter is not displayed.
38	Maximum active power (kW)	Specifies the output upper threshold for the maximum active power to adapt to different market requirements.	For 1000 V inverters, this parameter is configurable only for the SUN2000-25KTL-US, and the maximum value is 27.5 kW.
39	Tracker controller	Selects a controller vendor.	-
40	Adjust total energy yield (kWh)	Specifies the initial energy yield of the inverter. This parameter is used in inverter replacement scenarios. Set the initial energy yield of the new inverter to the total energy yield of the old inverter to ensure continuous statistics of cumulative energy yield.	-
41	Duration for determining short-time grid disconnection (ms)	The standards of certain countries and regions require that the inverter should not disconnect from the power grid if the power grid experiences a short-time failure. After the fault is rectified, the inverter output	-

No.	Parameter	Description	Remarks
		power needs to be quickly restored.	
42	Buzzer	If this parameter is set to Enable , the buzzer sounds when the DC input cable is incorrectly connected. If this parameter is set to Disable , the buzzer does not sound when the DC input cable is incorrectly connected.	-

A.3.2 Special User

No.	Parameter	Description	Remarks
1	Automatic OFF due to communication interrupted	The standards of certain countries and regions require that the inverter must shut down after the communication is interrupted for a certain time.	If Automatic OFF due to communication interrupted is set to Enable and the inverter communication is interrupted for a specified time (set by Communication interruption duration), the inverter will automatically shut down.
2	Communication interruption duration (min)	Specifies the duration for determining communication interruption. Used for automatic shutdown for protection in case of communication interruption.	-
3	Automatic ON due to communication resumed	If this parameter is set to Enable , the inverter automatically starts after communication recovers. If this parameter is set to Disable , the inverter needs to be started manually after communication recovers.	This parameter is displayed when Automatic OFF due to communication interrupted is set to Enable .
4	Soft start/boot time (s)	Specifies the duration for the power to gradually increase when the inverter starts.	-
5	LVRT	LVRT is short for low voltage ride-through. When the grid voltage is abnormally low for a short time, the inverter cannot disconnect from the power grid immediately and has to work for some time.	-
6	Threshold for triggering LVRT (V)	Specifies the threshold for triggering LVRT. The threshold settings should meet the local grid standard.	This parameter is displayed when LVRT is set to Enable .
7	LVRT compensation power factor of reactive power	During LVRT, the solar inverter needs to generate positive-sequence reactive power to support the power grid. This parameter is used to set the positive-	

No.	Parameter	Description	Remarks
	in positive sequence	sequence reactive power generated by the solar inverter. For example, if you set LVRT compensation power factor of reactive power in positive sequence to 2 , the positive-sequence reactive current generated by the solar inverter is 20% of the rated current when the AC voltage decreases by 10% during LVRT.	
8	LVRT compensation power factor of reactive power in negative sequence	During LVRT, the solar inverter needs to generate negative-sequence reactive power to support the power grid. This parameter is used to set the negative-sequence reactive power generated by the solar inverter. For example, if you set LVRT compensation power factor of reactive power in negative sequence to 2 , the negative-sequence reactive current generated by the solar inverter is 20% of the rated current when the AC voltage decreases by 10% during LVRT.	
9	Percentage of LVRT reactive current limiting	During LVRT, the solar inverter needs to limit the reactive current. For example, if you set Percentage of LVRT reactive current limiting to 50 , the reactive current upper limit of the solar inverter is 50% of the rated current during LVRT.	
10	Threshold of LVRT zero-current mode	When Zero current due to power grid fault is enabled, if the power grid voltage is less than the value of Threshold of LVRT zero-current mode during LVRT, the zero current mode is used. Otherwise, the mode configured in LVRT mode is used.	
11	LVRT mode	Sets LVRT mode. The options are Zero-current mode , Constant current mode , Reactive power priority mode , and Active power priority mode .	
12	LVRT reactive power compensation factor	During LVRT, the inverter needs to generate reactive power to support the power grid. This parameter is used to set the reactive power generated by the inverter.	<ul style="list-style-type: none"> This parameter is displayed when LVRT is set to Enable. For example, if this parameter is set to 2, the reactive power generated by the inverter is 20% of the rated power when the AC voltage drops by 10% during LVRT.

No.	Parameter	Description	Remarks
13	LVRT characteristic curve	Specifies the low voltage ride-through capability of the inverter.	-
14	HVRT	HVRT is short for high voltage ride-through. When the grid voltage is abnormally high for a short time, the inverter cannot disconnect from the power grid immediately and has to work for some time.	-
15	Threshold for triggering HVRT (V)	Specifies the threshold for triggering HVRT. The threshold settings should meet the local grid standard.	This parameter is displayed when HVRT is set to Enable .
16	HVRT compensation power factor of reactive power in positive sequence	During HVRT, the solar inverter needs to generate positive-sequence reactive power to support the power grid. This parameter is used to set the positive-sequence reactive power generated by the solar inverter. For example, if you set HVRT compensation power factor of reactive power in positive sequence to 2 , the positive-sequence reactive current generated by the solar inverter is 20% of the rated current when the AC voltage increases by 10% during HVRT.	
17	HVRT compensation power factor of reactive power in negative sequence	During HVRT, the solar inverter needs to generate negative-sequence reactive power to support the power grid. This parameter is used to set the negative-sequence reactive power generated by the solar inverter. For example, if you set HVRT compensation power factor of reactive power in negative sequence to 2 , the negative-sequence reactive current generated by the solar inverter is 20% of the rated current when the AC voltage increases by 10% during HVRT.	
18	HVRT compensation power factor of reactive power in positive sequence	During HVRT, the inverter needs to generate reactive power to support the power grid. This parameter is used to set the reactive power generated by the inverter.	
19	VRT exit hysteresis threshold	Specifies the LVRT/HVRT recovery threshold.	
			<ul style="list-style-type: none"> This parameter is displayed when LVRT or HVRT is set to Enable. LVRT recovery threshold =

No.	Parameter	Description	Remarks
			<p>Threshold for triggering LVRT + VRT exit hysteresis threshold</p> <ul style="list-style-type: none"> HVRT recovery threshold = Threshold for triggering HVRT + VRT exit hysteresis threshold
20	LVRT undervoltage protection shield	Specifies whether to shield the undervoltage protection function during LVRT.	This parameter is displayed when LVRT is set to Enable .
21	Grid voltage protection shield during VRT	Specifies whether to shield the undervoltage protection function during LVRT or HVRT.	This parameter is displayed when LVRT or HVRT is set to Enable .
22	Grid voltage jump triggering threshold (%)	Specifies the LVRT or HVRT threshold for triggering a transient voltage jump of a power grid. A transient voltage jump indicates that the inverter cannot immediately disconnect from the power grid when the power grid is abnormal due to transient changes.	This parameter is available when Grid code is set to VDE 4120 .
23	Zero current due to power grid fault	Certain countries and regions have requirements on the output current during high/low voltage ride-through. In this case, set this parameter to Enable . After this parameter is set to Enable , the output current is less than 10% of the rated current during high/low voltage ride-through.	This parameter is displayed when LVRT or HVRT is set to Enable .
24	Active islanding protection	Specifies whether to enable the active islanding protection function.	-
25	Passive islanding protection	Specifies whether to enable the passive islanding protection function.	This parameter is displayed if the Japanese grid code is selected.
26	Voltage rise suppression	The standards of certain countries and regions require that when the output voltage exceeds a certain value, the inverter must suppress voltage rise by outputting reactive power and reducing active power.	-
27	Voltage rise suppressing reactive power adjustment point (%)	The standards of certain countries and regions require that the inverter generate a certain amount of reactive power when the output voltage exceeds a certain value.	<ul style="list-style-type: none"> This parameter is displayed when Voltage rise suppression is set to Enable. The value of Voltage rise suppressing active power derating point must be greater than that of Voltage rise suppressing reactive power adjustment point.
28	Voltage rise suppressing active power derating point	The standards of certain countries and regions require that the active power of the inverter be derated according to a certain slope when the output voltage	

No.	Parameter	Description	Remarks
	(%)	exceeds a certain value.	
29	Voltage rise suppression P-U curve	The standards of certain countries and regions require that the P-U curve be set.	This parameter is displayed when Voltage rise suppression is set to Enable .
30	Voltage rise suppression Q-U curve	The standards of certain countries and regions require that the Q-U curve be set.	
31	Frequency change rate protection	Set this parameter to Enable to protect the inverter when the grid frequency changes too fast.	-
32	Frequency change rate protection threshold (Hz/s)	Specifies the frequency change rate protection threshold.	This parameter is displayed if Frequency change rate protection is set to Enable .
33	Frequency change rate protection duration (s)	The inverter is protected when the grid frequency change duration exceeds the value.	
34	Soft start time after grid failure (s)	Specifies the time for the power to gradually increase when the inverter restarts after the power grid recovers.	-
35	TCP heartbeat interval (s)	Specifies the TCP link timeout period for the solar inverter to connect to the management system.	-
36	TCP frame length	Specifies the maximum length of the TCP frame sent by the northbound device to the solar inverter.	-
37	Heartbeat period at application layer (min)	Specifies the timeout period for the solar inverter to connect to the management system.	-

A.4 Power adjustment parameters

A.4.1 Special User

No.	Parameter	Description	Remarks
1	Remote power schedule	If this parameter is set to Enable , the inverter responds to the scheduling instruction from the remote port. If this parameter is set to Disable , the inverter does not respond to the scheduling instruction from the remote port.	-

No.	Parameter	Description	Remarks
2	Schedule instruction valid duration (s)	Specifies the time for maintaining the scheduling instruction.	When this parameter is set to 0, the scheduling instruction takes effect permanently.
3	Maximum apparent power (kVA)	Specifies the output upper threshold for the maximum apparent power to adapt to the capacity requirements of standard and customized inverters.	If the maximum active power equals the value of Smax_limit, this parameter is not displayed.
4	Maximum active power (kW)	Specifies the output upper threshold for the maximum active power to adapt to different market requirements.	-
5	OFF at 0% power limit	If this parameter is set to Enable , the inverter shuts down after receiving the 0% power limit command. If this parameter is set to Disable , the inverter does not shut down after receiving the 0% power limit command.	-
6	Active power change gradient (%/s)	Specifies the change speed of the inverter active power.	-
7	Derated by fixed active power (kW)	Adjusts the active power output of the inverter by fixed value.	This parameter is displayed if Remote power schedule is set to Enable . For 1000 V inverters, the maximum value of this parameter for the SUN2000-25KTL-US is 27.5 kW.
8	Derated by active power % (%)	Adjusts the active power output of the inverter by percentage.	This parameter is displayed if Remote power schedule is set to Enable . If this parameter is set to 100 , the inverter outputs based on the maximum output power.
9	Reactive power change gradient (%/s)	Specifies the change speed of the inverter reactive power.	-
10	Plant active power gradient (min/100%)	Specifies the rate of active power rise due to sunlight changes.	-
11	Average active power filtering time (ms)	Specifies the period of active power rise due to sunlight changes. This parameter is used with Plant active power gradient .	-
12	PF (U) voltage detection filtering time (s)	Specifies the time for filtering the grid voltage in the PF-U curve.	-
13	Reactive power	Specifies the adjustment time for the	-

No.	Parameter	Description	Remarks
	adjustment time (s)	reactive power to reach the target value during reactive power adjustment.	
14	Power factor	Specifies the power factor of the inverter.	This parameter is displayed if Remote power schedule is set to Enable .
15	Reactive power compensation (Q/S)	Specifies the reactive power output by the inverter.	
16	Night-time reactive power compensation (Q/S)	During the reactive power compensation at night, the reactive power is scheduled by percentage.	-
17	Night-time reactive power output	In some specific application scenarios, a power grid company requires that the inverter can perform reactive power compensation at night to ensure that the power factor of the local power grid meets requirements.	This parameter is displayed when Isolation settings is set to Input ungrounded, with TF .
18	Enable reactive power parameters at night	When this parameter is set to Enable , the inverter outputs reactive power based on the setting of Reactive power compensation at night . Otherwise, the inverter executes the remote scheduling command.	This parameter is displayed when Night-time reactive power output is set to Enable .
19	Night-time reactive power compensation (kVar)	During the reactive power compensation at night, the reactive power is scheduled by fixed value.	This parameter is displayed when Night-time reactive power output and Enable reactive power parameters at night are set to Enable .
20	Overfrequency derating	If this parameter is set to Enable , the active power of the inverter will be derated according to a certain slope when the grid frequency exceeds the frequency that triggers overfrequency derating.	-
21	Frequency for triggering overfrequency derating (Hz)	The standards of certain countries and regions require that the output active power of inverters be derated when the power grid frequency exceeds a certain value.	<ul style="list-style-type: none"> This parameter is displayed when Overfrequency derating is set to Enable. When setting this parameter, ensure that the following condition is met: Frequency for exiting overfrequency derating ≤ Frequency for triggering overfrequency derating < Cutoff frequency of overfrequency derating.
22	Frequency for exiting overfrequency derating (Hz)	Specifies the frequency threshold for exiting overfrequency derating.	
23	Cutoff frequency of overfrequency derating (Hz)	Specifies the frequency threshold for cutting off overfrequency derating.	
24	Cutoff power of overfrequency derating (%)	Specifies the power threshold for cutting off overfrequency derating.	

No.	Parameter	Description	Remarks
25	Frequency detection filtering time (ms)	Specifies the frequency detection filter time.	
26	Overfrequency derating power drop gradient (%/s)	Specifies the decrease rate of the overfrequency derating power.	
27	Power recovery gradient of overfrequency derating (%/min)	Specifies the recovery rate of the overfrequency derating power.	
28	Voltage derating	If this parameter is set to Enable , the active power of the inverter will be derated according to a certain slope when the grid voltage exceeds the voltage that triggers overfrequency derating.	-
29	Voltage derating start point (V)	Specifies the start point for voltage derating.	<ul style="list-style-type: none"> • This parameter is displayed when Voltage derating is set to Enable. • When setting this parameter, ensure that the following condition is met: Voltage derating start point < Voltage derating stop point.
30	Cut-off point of voltage derating (V)	Specifies the stop point for voltage derating.	
31	Voltage derating cut-off power (V)	Specifies the power threshold for cutting off voltage derating.	
32	Communication disconnection fail-safe	In the inverter export limitation scenario, if this parameter is set to Enable , the inverter will perform active power derating by percentage when the communication between the inverter and the SmartLogger or Smart Dongle is disconnected for more than the time specified by Communication disconnection detection time .	N/A
33	Communication disconnection detection time (s)	Specifies the fail-safe detection time for the disconnection between the inverter and the SmartLogger or Smart Dongle.	This parameter is displayed when Communication disconnection fail-safe is set to Enable .
34	Active power output limit for fail-safe (%)	Specifies the derating value of the inverter active power by percentage.	
35	Apparent power baseline (kVA)	Adjusts the apparent output baseline of the inverter.	-
36	Active power baseline (kW)	Adjusts the active output baseline of the inverter.	-
37	Frequency modulation control	The standards of certain countries and regions require that if the power grid frequency fluctuates around a certain value, the inverter needs to fine-tune the active	-

No.	Parameter	Description	Remarks
		power output based on Frequency modulation control droop to help stabilize the power grid frequency. In this case, set this parameter to Enable	
38	Adjustment ratio of frequency modulation control	Specifies the droop of the active power output.	This parameter is displayed when Frequency modulation control is set to Enable .
39	Underfrequency rise power	The standards of certain countries and regions require that if the power grid frequency is lower than Frequency for triggering of underfrequency rise power , the inverter needs to increase the active power output to help increase the power grid frequency. In this case, set this parameter to Enable .	-
40	Frequency for triggering of underfrequency rise power (Hz)	Specifies the frequency threshold of Underfrequency rise power .	This parameter is displayed when Underfrequency rise power is set to Enable .
41	Power recovery gradient of underfrequency rise (%/min)	Specifies the recovery rate of Underfrequency rise power .	
42	Cutoff frequency of underfrequency rise power (Hz)	Specifies the cutoff frequency of Underfrequency rise power .	
43	Cutoff power of underfrequency rise power (%)	Specifies the cutoff power of Underfrequency rise power .	
44	Frequency for exiting of underfrequency rise power (Hz)	Specifies the exit frequency of Underfrequency rise power .	
45	Q-U characteristic curve mode	Specifies the reactive power compensation mode of the inverter output.	-
46	Power percentage for triggering Q-U scheduling	Specifies the reference apparent power, in percentage. When the actual apparent power of the inverter is greater than the value of this parameter, the Q-U characteristic curve scheduling function is enabled.	-
47	Q-U characteristic curve	The inverter adjusts Q/S (the ratio of the output reactive power to apparent power) in real time based on U/Un(%) (the ratio of the actual power grid voltage to the rated power grid voltage).	-

No.	Parameter	Description	Remarks
48	Q-P characteristic curve	The inverter adjusts Q/Pn (the ratio of the output reactive power to the rated active power) in real time based on P/Pn(%) (the ratio of the actual active power to the rated active power).	-
49	Cosφ-P/Pn characteristic curve	The inverter adjusts the output power factor cosφ in real time based on P/Pn(%).	-

A.5 Grid-tied control parameters

Special User

Table A-1 Grid-tied control parameters

Parameter	Description
Active power control mode	Specifies the active power output mode at the grid-tied point.
Closed-loop controller	Specifies the grid-tied power controller. Before setting the parameter, confirm the controller type. Incorrect setting will result in abnormal power output of the solar inverter. Solar inverter applies only to the scenario where a single solar inverter is used or where a single solar inverter is used with an SDongle.
Limitation mode	Specifies the active power limitation mode as required by the power grid.
PV plant capacity (kW)	Specifies the PV array capacity.
Maximum grid feed-in power (kW)	In Grid connection with limited power (kW) mode , set the maximum power fed to the power grid from the PV array.
Maximum grid feed-in power (%)	In Grid connection with limited power (%) mode , set the proportion of the maximum power fed to the power grid from the PV array to the capacity of the PV plant.
Power adjustment period (s)	Specifies the interval for sending adjustment commands.
Maximum protection time (s)	Specifies the protection duration to determine whether the communication between the external controller and the Smart Power Sensor is interrupted.
Power control hysteresis (kW)	Specifies the dead zone for adjusting the

Parameter	Description
	inverter output power. If the power fluctuation is within the power control hysteresis, the power is not adjusted.
Fail-safe power threshold (%)	When the communication between the SDongle/SmartLogger, power meter, and solar inverter is interrupted, the solar inverter generates power based on this threshold.
Reactive power control mode	Specifies the reactive power output mode at the grid-tied point.
Power factor	Specifies the target power factor of the power meter.
Adjustment period (s)	Specifies the interval for sending adjustment commands.
Adjustment deadband	Specifies the adjustment power factor precision.
Fail-safe power factor	When the communication between the SDongle/SmartLogger, power meter, and solar inverter is interrupted, the solar inverter generates power based on this threshold.
Communication disconnection fail-safe	When this parameter is set to Enable , and the communication between the solar inverter and the SDongle/SmartLogger is interrupted for a certain period (set by Communication disconnection detection time), the solar inverter generates power based on Fail-safe power .
Communication disconnection detection time (s)	Specifies the protection duration to determine whether the communication between the SDongle/SmartLogger and the solar inverter is interrupted.

B Domain Name List of Management Systems

 **NOTE**

The list is subject to change.

Table B-1 Domain names of management systems

Domain Name	Data Type	Scenario
intl.fusionsolar.huawei.com	Public network address	FusionSolar hosting cloud NOTE Compatible with the former FusionSolar hosting cloud domain name cn.fusionsolar.huawei.com for the Chinese mainland.
neteco.alsoenergy.com	Public network address	Partner's management system
re-ene.kyuden.co.jp	Public network address	Remote output control server of Kyushu Electric Power Company
re-ene.yonden.co.jp	Public network address	Remote output control server of Shikoku Electric Power Company
eu.fusionsolar.huawei.com	Public network address	Network management system FusionSolar in Europe
au1.fusionsolar.huawei.com	Public network address	Network management system FusionSolar in Australia
br1.fusionsolar.huawei.com	Public network address	Network management system FusionSolar in Brazil
huawei.devicedataacquisitio	Public network address	Third-party network

Domain Name	Data Type	Scenario
n.com		management system Locus dedicated for the United States

C Public URLs

Table C-1 Public URLs of the SUN2000 APP

URL	Description
https://solar.huawei.com/~media/Solar/Device/invert.xml	The mobile phone automatically detects software updates when connected to the Internet. If the device upgrade package or grid code is updated, a message is displayed to prompt users to download the upgrade package or grid code. After the distributed solar inverter is connected, the system prompts you to install the upgrade package.
https://solar.huawei.com/~media/Solar/Device/DeviceUpgrade.zip	Download the device upgrade package.
https://solar.huawei.com/~media/Solar/Device/InverterGridCode.zip	Download the grid code update package.
https://support.huawei.com/enterprise/en/doc/EDOC1100054980	View the app quick guide.
https://solar.huawei.com/na/appversion	The mobile phone automatically obtaining app version information when connected to the Internet.

Table C-2 Public URLs of the FusionSolar APP

URL	Description
https://support.huawei.com/enterprise/	View the app guide.
*.apple.com	Official website of Apple. The iOS version of the FusionSolar app needs to connect to this website for upgrade.
*.pinnettech.com	Official website of Pinnet Technologies. The FusionSolar app needs to connect to this website for upgrade.

D Acronyms and Abbreviations

A

AFCI arc-fault circuit-interrupter

APP application

L

LCD liquid crystal display

M

MBUS monitoring bus

P

PID potential induced degradation

PV photovoltaic

S

SD secure digital memory card