

Installation manual

SMA RS485 MODULE

MD.485-40 (PC-485.BG1)

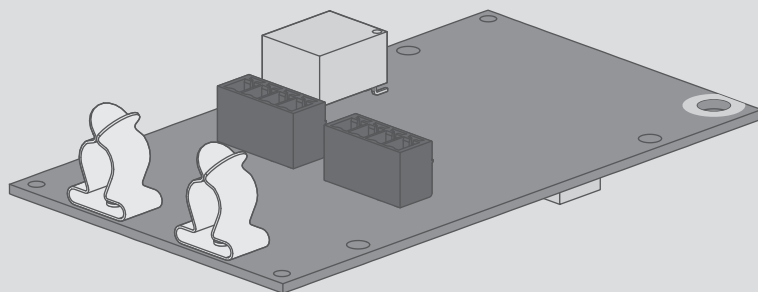

Legal Provisions

The information contained in these documents is property of SMA Solar Technology AG. Any publication, whether in whole or in part, requires prior written approval by SMA Solar Technology AG. Internal reproduction used solely for the purpose of product evaluation or other proper use is allowed and does not require prior approval.

SMA Warranty

You can download the current warranty conditions from the Internet at www.SMA-Solar.com.

Trademarks

All trademarks are recognized, even if not explicitly identified as such. Missing designations do not mean that a product or brand is not a registered trademark.

Modbus® is a registered trademark of Schneider Electric and is licensed by the Modbus Organization, Inc.

QR Code is a registered trademark of DENSO WAVE INCORPORATED.

Phillips® and Pozidriv® are registered trademarks of Phillips Screw Company.

Torx® is a registered trademark of Acument Global Technologies, Inc.

SMA Solar Technology AG

Sonnenallee 1

34266 Niestetal

Germany

Tel. +49 561 9522-0

Fax +49 561 9522-100

www.SMA.de

Email: info@SMA.de

Status: 9/18/2017

Copyright © 2017 SMA Solar Technology AG. All rights reserved.

Table of Contents

1	Information on this Document	4
1.1	Validity	4
1.2	Target Group	4
1.3	Additional Information.....	4
1.4	Symbols.....	4
1.5	Typographies	5
1.6	Nomenclature	5
2	Safety	6
2.1	Intended Use.....	6
2.2	Safety Information	6
3	Scope of Delivery	8
4	Product Description	9
4.1	SMA RS485 Module	9
4.2	Type Label.....	9
5	Mounting.....	11
5.1	Mounting position.....	11
5.2	Installing the Module.....	11
6	Connection	13
6.1	Preparing the Connection Cable	13
6.2	Inserting the Cables.....	13
6.3	Connecting the Cable	14
7	Decommissioning	16
7.1	Removing the Module	16
7.2	Packing the Product for Shipment.....	17
7.3	Disposing of the Product	17
8	Technical Data	18
9	Contact	19
10	EU Declaration of Conformity	21

1 Information on this Document

1.1 Validity

This document is valid for the SMA RS485 Module (MD.485-40) with assembly designation "PC-485.BG1" from hardware version A1.

1.2 Target Group

The tasks described in this document must only be performed by qualified persons. Qualified persons must have the following skills:









- Knowledge of how an inverter works and is operated
- Training in how to deal with the dangers and risks associated with installing and using electrical devices and installations
- Training in the installation and commissioning of electrical devices and installations
- Knowledge of the applicable standards and directives
- Knowledge of and compliance with this document and all safety information

1.3 Additional Information

Links to additional information can be found at www.SMA-Solar.com:

Document title	Document type
"RS485 Cabling Plan"	Installation manual

1.4 Symbols

Symbol	Explanation
	Indicates a hazardous situation which, if not avoided, will result in death or serious injury
	Indicates a hazardous situation which, if not avoided, can result in death or serious injury
	Indicates a hazardous situation which, if not avoided, can result in minor or moderate injury
	Indicates a situation which, if not avoided, can result in property damage
	Information that is important for a specific topic or goal, but is not safety-relevant
	Indicates a requirement for meeting a specific goal
	Desired result
	A problem that might occur

1.5 Typographies

Typography	Use	Example
bold	<ul style="list-style-type: none"> • Display texts • Elements on a user interface • Terminals • Elements to be selected • Elements to be entered 	<ul style="list-style-type: none"> • The value can be found in the field Energy. • Select Settings. • Enter 10 in the field Minutes.
>	<ul style="list-style-type: none"> • Connects several elements to be selected 	<ul style="list-style-type: none"> • Select Settings > Date.
[Button] [Key]	<ul style="list-style-type: none"> • Button or key to be selected or pressed 	<ul style="list-style-type: none"> • Select [Next].

1.6 Nomenclature

Complete designation	Designation in this document
PV system	PV system

2 Safety

2.1 Intended Use

The SMA RS485 Module enables SMA inverters to establish wired RS485 communication.

The RS485 Module must only be installed in the following SMA inverters:

- STP 50-40 (Sunny Tripower CORE1)

The inverter still complies with the standard after the product has been installed.

The product must only be used in countries for which it is approved or released by SMA Solar Technology AG and the grid operator.

All components must remain within their permitted operating ranges and their installation requirements at all times.

Use this product only in accordance with the information provided in the enclosed documentation and with the locally applicable standards and directives. Any other application may cause personal injury or property damage.

Alterations to the product, e.g. changes or modifications, are only permitted with the express written permission of SMA Solar Technology AG. Unauthorized alterations will void guarantee and warranty claims and in most cases terminate the operating license. SMA Solar Technology AG shall not be held liable for any damage caused by such changes.

Any use of the product other than that described in the Intended Use section does not qualify as the intended use.

The enclosed documentation is an integral part of this product. Keep the documentation in a convenient place for future reference and observe all instructions contained therein.

The type label must remain permanently attached to the product.

2.2 Safety Information

This section contains safety information that must be observed at all times when working on or with the product.

To prevent personal injury and property damage and to ensure long-term operation of the product, read this section carefully and observe all safety information at all times.

DANGER

Danger to life due to high voltages of the PV array

When exposed to light, the PV array generates dangerous DC voltage, which is present in the DC conductors and the live components of the inverter. Touching the DC conductors or the live components can lead to lethal electric shocks.

- Prior to performing any work on the inverter, always disconnect the inverter from voltage sources on the AC and DC sides as described in the inverter manual. When doing so, note that even if the DC load-break is switched off, there will be dangerous direct voltage present in the DC conductors of the inverter.

NOTICE**Damage to seals on the enclosure lids in subfreezing conditions**

If you open the enclosure lids when temperatures are below freezing, the enclosure seals can be damaged. This can lead to moisture entering the inverter.

- Only open the enclosure lids if the ambient temperature is not below -5°C
- If a layer of ice has formed on the seal of the lid when temperatures are below freezing, remove it prior to opening the enclosure lids (e.g. by melting the ice with warm air). Observe the applicable safety regulations.

NOTICE**Damage to the inverter or product due to electrostatic discharge**

Touching electronic components can cause damage to or destroy the inverter or the product through electrostatic discharge.

- Ground yourself before touching any component.

3 Scope of Delivery

Check the scope of delivery for completeness and any externally visible damage. Contact your distributor if the scope of delivery is incomplete or damaged.

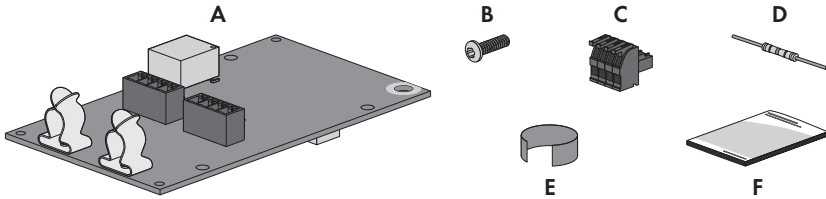

Figure 1: Components included in the scope of delivery

Position	Quantity	Designation
A	1	Module
B	1	Fastening screw (M5, TX 25)
C	2	4-pole terminal block
D	1	Terminator
E	2	Copper foil
F	1	Quick Reference Guide

4 Product Description

4.1 SMA RS485 Module

The SMA RS485 Module enables SMA inverters to establish wired RS485 communication.

Design of the Module

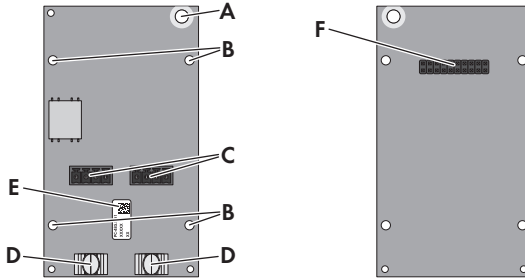

Figure 2: Design of the module

Position	Explanation
A	Opening for the fastening screw
B	Openings for the guide pins of the communication assembly
C	Jacks for connecting the 4-pole terminal blocks
D	Shield clamps
E	Type label
F	Connector strip on the back of the module for connection to the communication assembly in the inverter

4.2 Type Label

The type label clearly identifies the product. The type label is located on the front of the product.

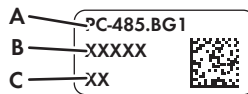

Figure 3: Design of the type label

Position	Explanation
A	Device type
B	Serial number
C	Hardware version

You will require the information on the type label to use the product safely and when seeking customer support from Service (see Section 9 "Contact", page 19).

5 Mounting

5.1 Mounting position

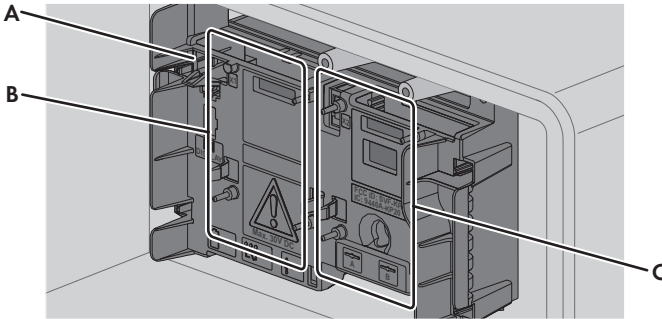

Figure 4: Communication assembly in the inverter with mounting position for the module

Position	Designation
A	Communication assembly
B	Module slot M1 *
C	Module slot M2

* Production resources SMA Solar Technology AG recommends using module slot **M1** for the module.

5.2 Installing the Module

i Maximum number of modules per inverter

You can only use a maximum of one module of the same device type per inverter.

Procedure:

1. **⚠ DANGER**

Danger to life due to high voltages of the PV array

When exposed to sunlight, the PV array generates dangerous DC voltage, which is present in the DC conductors and the live components of the inverter. Touching the DC conductors or the live components can lead to lethal electric shocks.

- Prior to performing any work on the inverter, always disconnect the inverter from voltage sources on the AC and DC sides as described in the inverter manual. When doing so, note that even if the DC load-break is switched off, there will be dangerous direct voltage present in the DC conductors of the inverter.
2. Remove the enclosure lid of the DC Connection Unit. Unscrew all screws with a Torx screwdriver (TX 25) and remove the enclosure lid carefully forward.
 3. Set the screws and the enclosure lid aside and store safely.

4. Install the module at the desired mounting location. Perform the following steps:

- Guide the three guide pins on the communication assembly through the holes in the module. The holes in which the guide pins must be inserted depend on the mounting location.

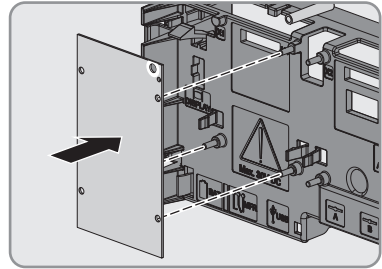

- Carefully push the module down on the upper edge and on the connection sockets until it audibly snaps into both side locking tabs of the communication assembly. The connector strip on the back of the module is automatically pushed into the socket terminal strip of the communication assembly.

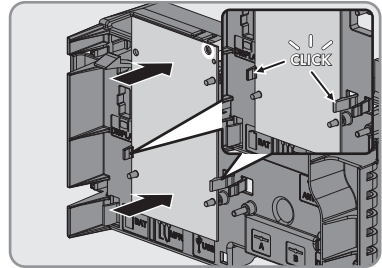

5. Screw tight the fastening screw with a Torx screwdriver (TX 25) on the module (torque: 1.5 Nm). This additionally fixes the module in place and grounds it in the inverter enclosure.

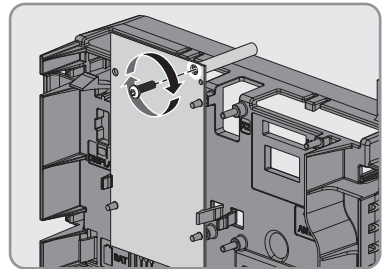

6 Connection

6.1 Preparing the Connection Cable

Depending on whether the module is located at the end or in the middle of the communication bus, prepare one or two connection cables as described in the following.

Requirements:

- The cable requirements must be complied with (see Installation Instructions "RS485 Cabling Plan" at www.SMA-Solar.com).
- Diameter of the cable when using the cable support sleeve with one hole: at maximum 17 mm
- Diameter of the cable when using the cable support sleeve with two holes: at maximum 6.5 mm

Procedure:

1. Strip 40 mm of cable sheath from the end of the connection cable to which the terminal block is to be attached. Make sure that no pieces of cable are dropped into the inverter.
2. Trim the cable shield to a length of 15 mm and fold it over the cable sheath.

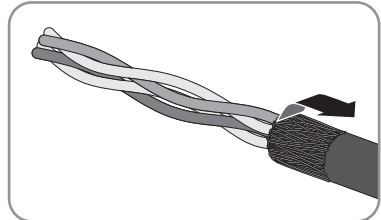

3. Wrap the cable shield with copper foil.

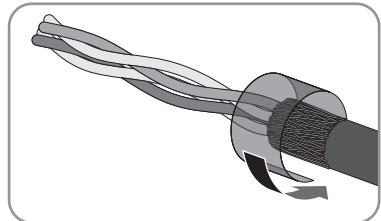

4. Strip the insulation on the three insulated conductors each by 6 mm. The two insulated conductors used for communication must be a twisted pair.
5. Trim unneeded insulated conductors of the connection cable flush with the cable sheath.

6.2 Inserting the Cables

Additionally required material (not included in the scope of delivery):

- Connection cable (see Section 6.1, page 13)

Procedure:

1. Make sure that the inverter has been disconnected and is secured against reconnection (see the inverter manual).
2. Remove the swivel nut from the cable gland for the communication cable.
3. Thread the swivel nut over the cable.
4. Press the two-hole cable support sleeve out of the cable gland.
5. Remove the sealing plug from one of the enclosure openings of the two-hole cable support sleeve and insert the cable into the enclosure opening.
6. Press the two-hole cable support sleeve with the cable into the cable gland and guide the cable to the communication assembly in the DC Connection Unit. Ensure that any unused enclosure openings of the two-hole cable support sleeve are sealed with sealing plugs.
7. Tighten the swivel nut on the cable gland hand-tight. This will secure the cable.

6.3 Connecting the Cable

Assignment of the terminal block:

Terminal block	Clamping position	Assignment
	2	Data+ (D+)
	3	Not assigned
	5	Ground (GND)
	7	Data- (D-)

Procedure:

1. Plug a terminal block each into the jack on the module.

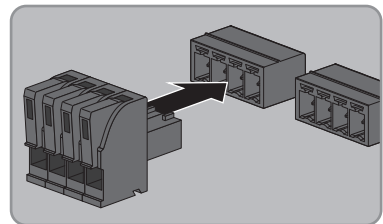

2. If one connection cable is to be connected, attach the terminator:

- Push the levers of the terminals 2 and 7 of a terminal block upwards.
- Bend the ends of the terminator downwards and plug the terminator into the open terminals.
- Close the levers of the terminals.

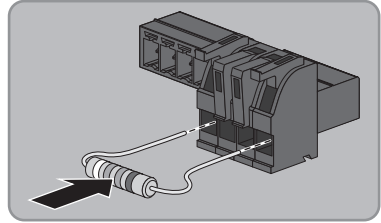

3. Push the levers of the terminals 2, 5 and 7 of a terminal block upwards.
4. Connect the insulated conductors to the terminals 2, 5 and 7 and note the insulated conductor colors (see Installation Instructions "RS485 Cabling Plan" at www.SMA-Solar.com).
5. Close the levers of the terminals.
6. Press each connection cable with the cable shield into the shield clamp on the module.

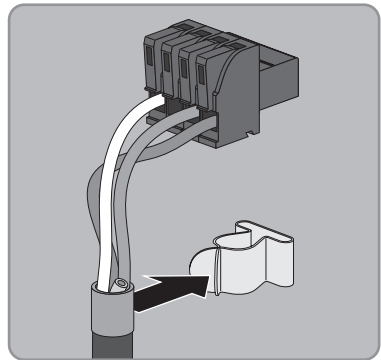

7. If no further connections are required on the module, close the inverter and commission it (see the inverter manual).

7 Decommissioning

7.1 Removing the Module

Procedure:

1. **⚠ DANGER**

Danger to life due to high voltages of the PV array

When exposed to sunlight, the PV array generates dangerous DC voltage, which is present in the DC conductors and the live components of the inverter. Touching the DC conductors or the live components can lead to lethal electric shocks.

- Prior to performing any work on the inverter, always disconnect the inverter from voltage sources on the AC and DC sides as described in the inverter manual. When doing so, note that even if the DC load-break is switched off, there will be dangerous direct voltage present in the DC conductors of the inverter.
2. Remove the enclosure lid of the DC Connection Unit. Unscrew all screws with a Torx screwdriver (TX 25) and remove the enclosure lid carefully forward.
 3. Set the screws and the enclosure lid aside and store safely.
 4. Remove all connecting terminal plates from the used connection sockets of the module.
 5. Unscrew the fastening screw on the module using a Torx screwdriver (TX 25).

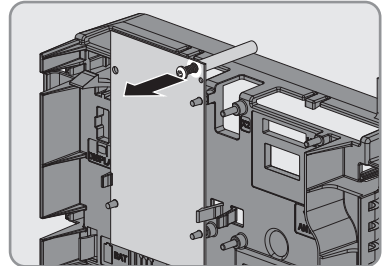

6. Remove the module:

- Press the right or left locking tab of the communication assembly slightly outwards and pull the module slightly forwards holding the lower end until the module is released from the interlock of the locking tab.

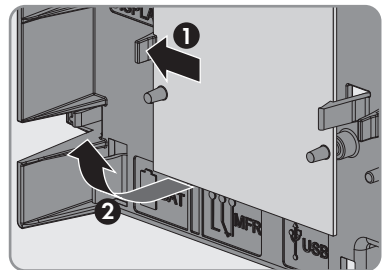

- Grab the module by the upper and lower edge with one hand.

- Slightly press the second locking tab outwards using the other hand and pull the module slightly forwards on the lower end until the module is released from the interlock of the locking tab.

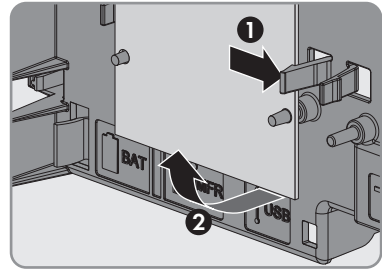

- Remove the module from its slot by pulling it forwards.
7. Remove the swivel nut from the cable gland for the communication cable.
 8. Lead the connection cable out of the two-hole cable support sleeve.
 9. Lead the connection cable out of the swivel nut.
 10. Close unused enclosure openings of the two-hole cable support sleeve with sealing plugs.
 11. Press the cable support sleeve into the two-hole cable gland.
 12. Tighten the swivel nut on the cable gland hand-tight.
 13. Close the inverter and, if necessary, recommission it (see inverter manual).

7.2 Packing the Product for Shipment

- Pack the product for shipping. Use the original packaging or packaging that is suitable for the weight and size of the product.

7.3 Disposing of the Product

- Dispose of the product in accordance with the locally applicable disposal regulations for electronic waste.

8 Technical Data

General Data

Mounting location	In the inverter
Voltage supply	Via the inverter

Mechanical Data

Width x height x depth	60 mm x 105 mm x 33 mm
------------------------	------------------------

Ambient Conditions for Storage/Transport

Ambient temperature	-40°C to +70°C
Relative humidity, non-condensing	10% to 100%
Maximum height above mean sea level	3000 m

Communication

Interface	RS485
Maximum cable length	1200 m

Terminals

Type of plug	4-pole spring-cage terminal
Number of RS485 connections	2

9 Contact

If you have technical problems with our products, please contact the SMA Service Line. We require the following information in order to provide you with the necessary assistance:

- Inverters:
 - Serial number
 - Firmware version
 - Special country-specific settings (if applicable)
- Module:
 - Serial number
 - Hardware version
- Detailed description of the problem

Deutschland	SMA Solar Technology AG	Belgien	SMA Benelux BVBA/SPRL
Österreich	Niestetal	Belgique	Mechelen
Schweiz	Sunny Boy, Sunny Mini Central, Sunny Tripower: +49 561 9522-1499 Monitoring Systems (Kommunikationsprodukte): +49 561 9522-2499 Fuel Save Controller (PV-Diesel-Hybridssysteme): +49 561 9522-3199 Sunny Island, Sunny Boy Storage, Sunny Backup: +49 561 9522-399 Sunny Central, Sunny Central Storage: +49 561 9522-299 SMA Online Service Center: www.SMA-Service.com	België	+32 15 286 730
		Luxemburg	SMA Online Service Center: www.SMA-Service.com
		Luxembourg	
		Nederland	
		Česko	SMA Service Partner TERMS a.s.
		Magyarország	+420 387 6 85 111
		Slovensko	SMA Online Service Center: www.SMA-Service.com
		Türkiye	SMA Service Partner DEKOM Ltd. Şti. +90 24 22430605 SMA Online Service Center: www.SMA-Service.com
France	SMA France S.A.S. Lyon +33 472 22 97 00 SMA Online Service Center : www.SMA-Service.com	Ελλάδα	SMA Service Partner AKTOR FM. Αθήνα +30 210 8184550 SMA Online Service Center: www.SMA-Service.com
		Κύπρος	

España Portugal	SMA Ibérica Tecnología Solar, S.L.U. Barcelona +34 935 63 50 99 SMA Online Service Center: www.SMA-Service.com	United Kingdom	SMA Solar UK Ltd. Milton Keynes +44 1908 304899 SMA Online Service Center: www.SMA-Service.com
Italia	SMA Italia S.r.l. Milano +39 02 8934-7299 SMA Online Service Center: www.SMA-Service.com	Bulgaria România	SMA Service Partner Renovatio Solar +40 372 756 599 SMA Online Service Center: www.SMA-Service.com
United Arab Emirates	SMA Middle East LLC Abu Dhabi +971 2234 6177 SMA Online Service Center: www.SMA-Service.com	India	SMA Solar India Pvt. Ltd. Mumbai +91 22 61713888
ไทย	SMA Solar (Thailand) Co., Ltd. บริษัท สแม โซลาร์ (ไทยแลนด์) จำกัด +66 2 670 6999	대한민국	SMA Technology Korea Co., Ltd. 서울 +82-2-520-2666
South Africa	SMA Solar Technology South Africa Pty Ltd. Cape Town 08600SUNNY (08600 78669) International: +27 (0)21 826 0600 SMA Online Service Center: www.SMA-Service.com	Argentina Brasil Chile Perú	SMA South America SPA Santiago de Chile +562 2820 2101
Australia	SMA Australia Pty Ltd. Sydney Toll free for Australia: 1800 SMA AUS (1800 762 287) International: +61 2 9491 4200	Other countries	International SMA Service Line Niestetal 00800 SMA SERVICE (+800 762 7378423) SMA Online Service Center: www.SMA-Service.com

10 EU Declaration of Conformity

within the scope of the EU directives

- Electromagnetic compatibility 2014/30/EU (29.3.2014 L 96/79-106)
(EMC)



SMA Solar Technology AG confirms herewith that the products described in this document are in compliance with the fundamental requirements and other relevant provisions of the above-mentioned directives. The entire EU Declaration of Conformity can be found at www.SMA-Solar.com.

