

System Manual

# SMA STORAGE PACKAGE - BUSINESS

with

## SUNNY TRIPOWER STORAGE STPS60-10

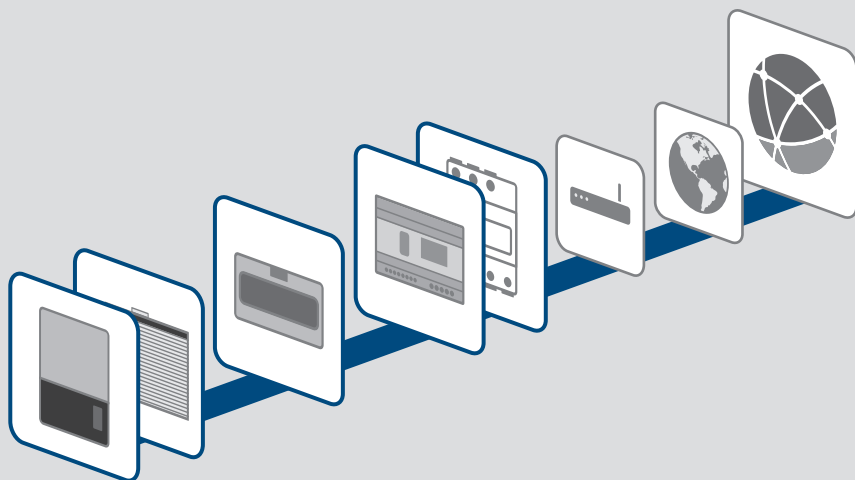

## Legal Provisions

The information contained in these documents is the property of SMA Solar Technology AG. No part of this document may be reproduced, stored in a retrieval system, or transmitted, in any form or by any means, be it electronic, mechanical, photographic, magnetic or otherwise, without the prior written permission of SMA Solar Technology AG. Internal reproduction used solely for the purpose of product evaluation or other proper use is allowed and does not require prior approval.

SMA Solar Technology AG makes no representations or warranties, express or implied, with respect to this documentation or any of the equipment and/or software it may describe, including (with no limitation) any implied warranties of utility, merchantability, or fitness for any particular purpose. All such representations or warranties are expressly disclaimed. Neither SMA Solar Technology AG nor its distributors or dealers shall be liable for any indirect, incidental, or consequential damages under any circumstances.

The exclusion of implied warranties may not apply in all cases under some statutes, and thus the above exclusion may not apply.

Specifications are subject to change without notice. Every attempt has been made to make this document complete, accurate and up-to-date. Readers are cautioned, however, that product improvements and field usage experience may cause SMA Solar Technology AG to make changes to these specifications without advance notice or per contract provisions. SMA Solar Technology AG shall not be responsible for any damages, including indirect, incidental or consequential damages, caused by reliance on the material presented, including, but not limited to, omissions, typographical errors, arithmetical errors or listing errors in the content material.

### SMA Warranty

You can download the current warranty conditions from the Internet at [www.SMA-Solar.com](http://www.SMA-Solar.com).

### Trademarks

All trademarks are recognized, even if not explicitly identified as such. Missing designations do not mean that a product or brand is not a registered trademark.

### SMA Solar Technology AG

Sonnenallee 1

34266 Niestetal

Germany

Tel. +49 561 9522-0

Fax +49 561 9522-100

[www.SMA.de](http://www.SMA.de)

Email: [info@SMA.de](mailto:info@SMA.de)

As of: 3/27/2020

Copyright © 2020 SMA Solar Technology AG. All rights reserved.

# Table of Contents

<b>1</b>	<b>Information on this Document .....</b>	<b>5</b>
1.1	Validity .....	5
1.2	Target Group .....	5
1.3	Content and Structure of this Document .....	5
1.4	Levels of Warning Messages .....	5
1.5	Symbols in the Document .....	6
1.6	Typographical Elements in the Document .....	6
1.7	Additional Information .....	6
<b>2</b>	<b>Safety .....</b>	<b>9</b>
2.1	Intended Use .....	9
2.2	IMPORTANT SAFETY INSTRUCTIONS.....	9
<b>3</b>	<b>System Components.....</b>	<b>10</b>
<b>4</b>	<b>System Overview .....</b>	<b>12</b>
4.1	Circuitry Overview Overall System.....	13
4.2	Communication Overview .....	14
<b>5</b>	<b>Installation .....</b>	<b>15</b>
5.1	Requirements for the Installation .....	15
5.2	Installation Procedure .....	16
5.3	Installing the Power Supply Unit.....	16
5.4	Installing the SMA Inverter Manager .....	16
5.5	Installing the Janitza UMB 604-PRO .....	17
5.6	Installing the SMA Energy Meter.....	17
5.7	Installing the SMA Data Manager.....	17
5.8	Installing the Battery.....	17
5.9	Installing the Battery Inverter .....	17
5.10	Connecting DC Cables to the Battery.....	18
5.11	Installing the PV Inverter (optional) .....	18
<b>6</b>	<b>Commissioning .....</b>	<b>19</b>
6.1	Information on Commissioning Support and Warranty.....	19
6.2	Commissioning Procedure .....	19
6.3	Configuring the Janitza UMG 604-PRO .....	20
6.4	Commissioning the Battery Inverter.....	20
6.5	Commissioning the Battery .....	20
6.6	Commissioning the PV Inverter (optional).....	20

6.7	Configuration of the storage system with LCS-Tool.....	21
6.7.1	Making the Main Configuration.....	21
6.7.2	Capturing the Janitza UMG 604-PRO.....	22
6.7.3	Setting the Peak Load Shaving Function (optional).....	22
6.7.4	Setting Time-of-Use (optional).....	24
6.8	Configuring the Overall System with the SMA Data Manager.....	25
6.9	Registering the System in Sunny Portal powered by ennexOS.....	26
6.10	Deactivating the Webconnect Function of the PV Inverters in Sunny Portal powered by ennexOS (optional).....	26
6.11	Configuring SMA SPOT in Sunny Portal powered by ennexOS (optional).....	27
6.12	Completing the Commissioning Report.....	27
<b>7</b>	<b>Contact .....</b>	<b>28</b>

# 1 Information on this Document

## 1.1 Validity

This document is valid for:

- SMA Storage Package - Business

## 1.2 Target Group

The tasks described in this document must only be performed by qualified persons. Qualified persons must have the following skills:

- Knowledge of how an inverter works and is operated
- Knowledge of how batteries work and are operated
- Training in how to deal with the dangers and risks associated with installing, repairing and using electrical devices, batteries and installations
- Training in the installation and commissioning of electrical devices and installations
- Participation in a certification training for the battery STORAGE-67-TS-10
- Knowledge of all applicable laws, standards and directives
- Knowledge of and compliance with this document and all safety information
- Knowledge of and compliance with the documents of the battery manufacturer with all safety information

## 1.3 Content and Structure of this Document

This document summarizes the specific information for the system and describes the procedure for installation and commissioning.

Circuitry overviews provide the basic principle of how a system must be set up and connected.

The latest version of this document and the comprehensive manual for installation, commissioning, configuration and decommissioning of each SMA product can be found in PDF format or as eManual at [www.SMA-Solar.com](http://www.SMA-Solar.com).

This document supplements the documents that are enclosed with each product and does not replace any locally applicable codes or standards. Read and observe all documents supplied with the product.

Illustrations in this document are reduced to the essential information and may deviate from the real product.

## 1.4 Levels of Warning Messages

The following levels of warning messages may occur when handling the product.

### DANGER

Indicates a hazardous situation which, if not avoided, will result in death or serious injury.

### WARNING

Indicates a hazardous situation which, if not avoided, could result in death or serious injury.



**⚠ CAUTION**

Indicates a hazardous situation which, if not avoided, could result in minor or moderate injury.

**NOTICE**

Indicates a situation which, if not avoided, can result in property damage.

## 1.5 Symbols in the Document



Symbol	Explanation
	Information that is important for a specific topic or goal, but is not safety-relevant
<input type="checkbox"/>	Indicates a requirement for meeting a specific goal
<input checked="" type="checkbox"/>	Desired result
<b>x</b>	A problem that might occur
	Example

## 1.6 Typographical Elements in the Document

Typography	Use	Example
<b>bold</b>	<ul style="list-style-type: none"> <li>Messages</li> <li>Terminals</li> <li>Elements on a user interface</li> <li>Elements to be selected</li> <li>Elements to be entered</li> </ul>	<ul style="list-style-type: none"> <li>Connect the insulated conductors to the terminals <b>X703:1</b> to <b>X703:6</b>.</li> <li>Enter <b>10</b> in the field <b>Minutes</b>.</li> </ul>
>	<ul style="list-style-type: none"> <li>Connects several elements to be selected</li> </ul>	<ul style="list-style-type: none"> <li>Select <b>Settings &gt; Date</b>.</li> </ul>
[Button] [Key]	<ul style="list-style-type: none"> <li>Button or key to be selected or pressed</li> </ul>	<ul style="list-style-type: none"> <li>Select <b>[Enter]</b>.</li> </ul>
#	<ul style="list-style-type: none"> <li>Placeholder for variable components (e.g., parameter names)</li> </ul>	<ul style="list-style-type: none"> <li>Parameter <b>WCtHz.Hz#</b></li> </ul>

## 1.7 Additional Information

For more information, please go to [www.SMA-Solar.com](http://www.SMA-Solar.com).

Title and information content	Type of information	Hyperlink and QR-Code
SUNNY TRIPOWER STORAGE 60 Detailed manual of the battery inverter	Installation manual	STPS60-IA-xx-1 2.pdf 
SMA INVERTER MANAGER / SMA DIGITAL I/O BOX / LCS-TOOL Detailed manual of the SMA In- verter Manager and the LCS-Tool	Installation manual	IMVIOBOX-IA-xx-1 6.pdf 

Title and information content	Type of information	Hyperlink and QR-Code
SMA DATA MANAGER M Detailed manual of the SMA Data Manager	Operating manual	<a href="https://manuals.sma.de/EDMM-10/index.html">https://manuals.sma.de/EDMM-10/index.html</a>

SMA ENERGY METER Detailed manual SMA Energy Meter	Installation manual	EMETER-20-1A-de-15.pdf
------------------------------------------------------	---------------------	------------------------



Please refer to the website of the battery manufacturer for further information on the batteries:

Tesvolt	STORAGE-67-TS-10	<a href="https://www.tesvolt.com/de">https://www.tesvolt.com/de</a>
---------	------------------	---------------------------------------------------------------------



## 2 Safety

### 2.1 Intended Use

The SMA Storage Package - Business is a storage system that can be optionally extended by a PV system. The SMA Storage Package - Business optimizes self-consumption of PV energy by the following measures:

- Intermediate storage of PV energy in the battery
- Energy management of the system with the SMA Data Manager
- Management of the storage system with the SMA Inverter Manager
- Data logging at the point of interconnection with the Janitza UMG 604-PRO
- Data logging of a customer-specific metering point with the SMA Energy Meter
- Visualization of PV system data in Sunny Portal powered by ennexOS

Grid feed-in and grid-supplied power are only recorded with the Janitza UMG 604-PRO. A Janitza UMG 604-PRO does not replace the energy meter of the electric utility company.

Use SMA products only in accordance with the information provided in the enclosed documentation and with the locally applicable laws, regulations, standards and directives. Any other application may cause personal injury or property damage.

### 2.2 IMPORTANT SAFETY INSTRUCTIONS

SAVE THESE INSTRUCTIONS

This section contains safety information that must be observed at all times when working.

#### DANGER

##### **Danger of fatal electric shock due to non-compliance with the safety instructions in the documents that are enclosed with each product.**

This document supplements the documents that are enclosed with each product and does not replace any locally applicable codes or standards.

- Read and observe all documents enclosed with the products.

### 3 System Components

Check the scope of delivery for completeness and any externally visible damage. Contact the Service if the delivery is incomplete or damaged.

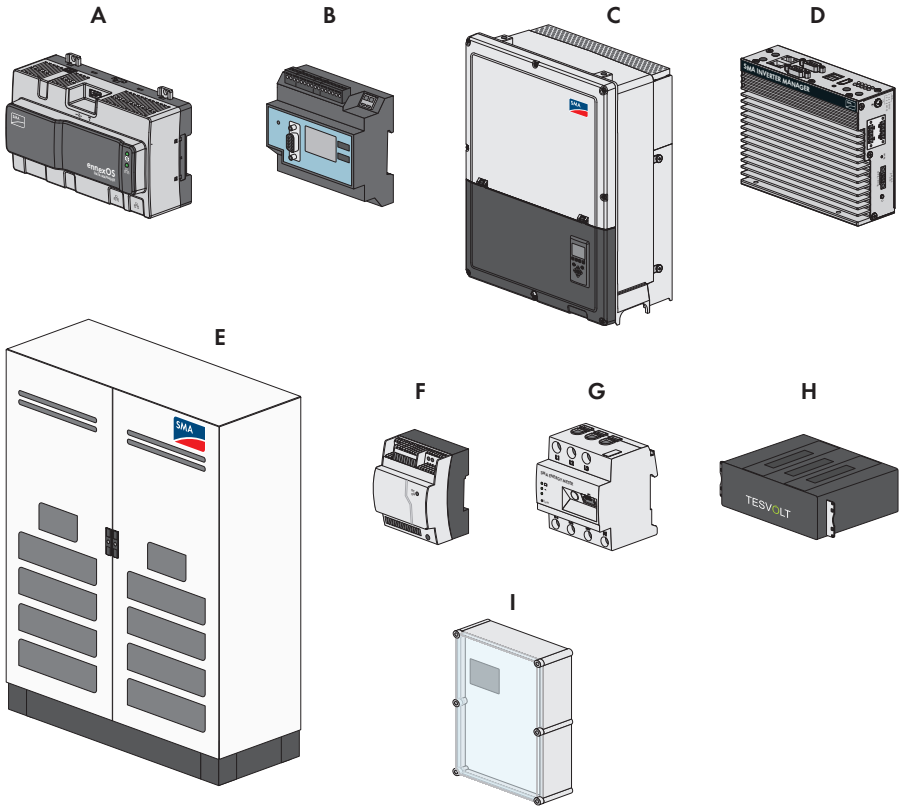

Figure 1: Main system components

Position	Quantity	Designation
A	1	SMA Data Manager M (EDMM-10) Data logger for monitoring and control of the system. The Data Manager transmits the data of the overall system to the Sunny Portal powered by ennexOS.
B	1	Janitza UMG 604-PRO The power analyzer UMG 604-PRO determines electrical measured values at the point of interconnection. The UMG 604-PRO transmits the measured values to the SMA Inverter Manager and to the SMA Data Manager.

Position	Quantity	Designation
C	1	Sunny Tripower Storage 60 (STPS 60-10) Battery inverter that controls charging and discharging of the battery by means of the specifications of the SMA Inverter Manager.
D	1	SMA Inverter Manager Data logger for the control of the storage system. The SMA Inverter Manager transmits the data of the storage system to the SMA Data Manager.
E	1	STORAGE-67-TS-10 including 14 battery modules
F	1	Power supply unit CLCON-PWRSUPPLY Provides the supply voltage for the SMA Data Manager, the SMA Inverter Manager and the Janitza UMG 604-PRO.
G	1	SMA Energy Meter (EMETER-20) The SMA Energy Meter determines the electrical measured values of a customer-specific metering point and transmits these to the SMA Data Manager.
H	1	Storage Extension Kit TV-10 (optional) Extension kit for battery-storage system consisting of two battery modules and two module connector sets HV1000
I	1	Battery Storage Combiner TV-10 (optional) Battery fuse box incl. circuit breaker for the fuse protection of the battery system between STORAGE-67-TS-10 and battery inverter (for up to 4 Storage-67-TV-10)

# 4 System Overview

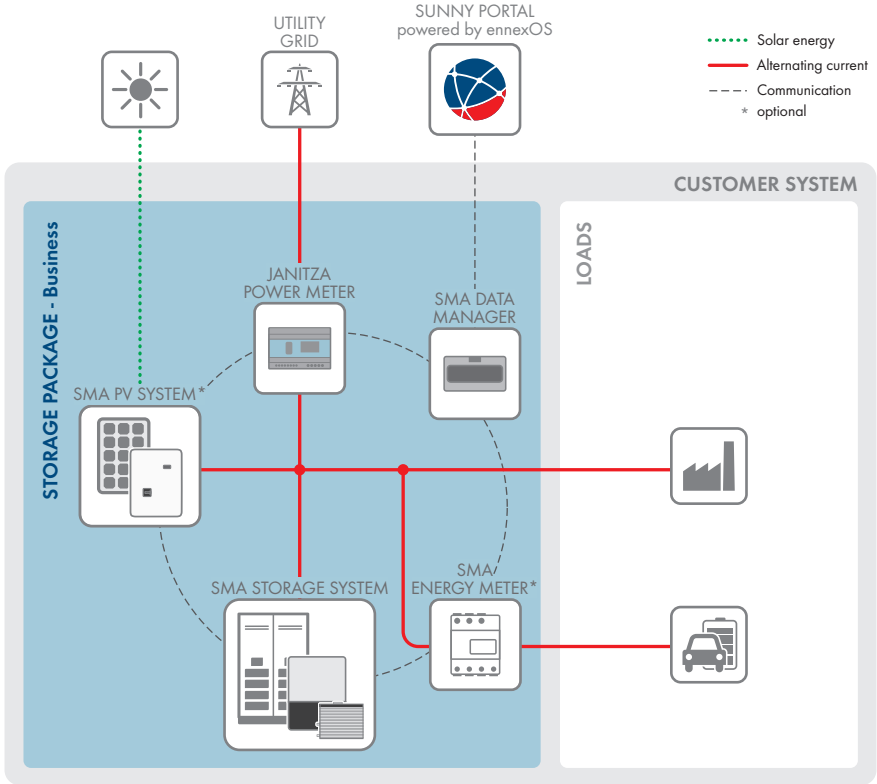

Figure 2: Design of the system

### 4.1 Circuitry Overview Overall System

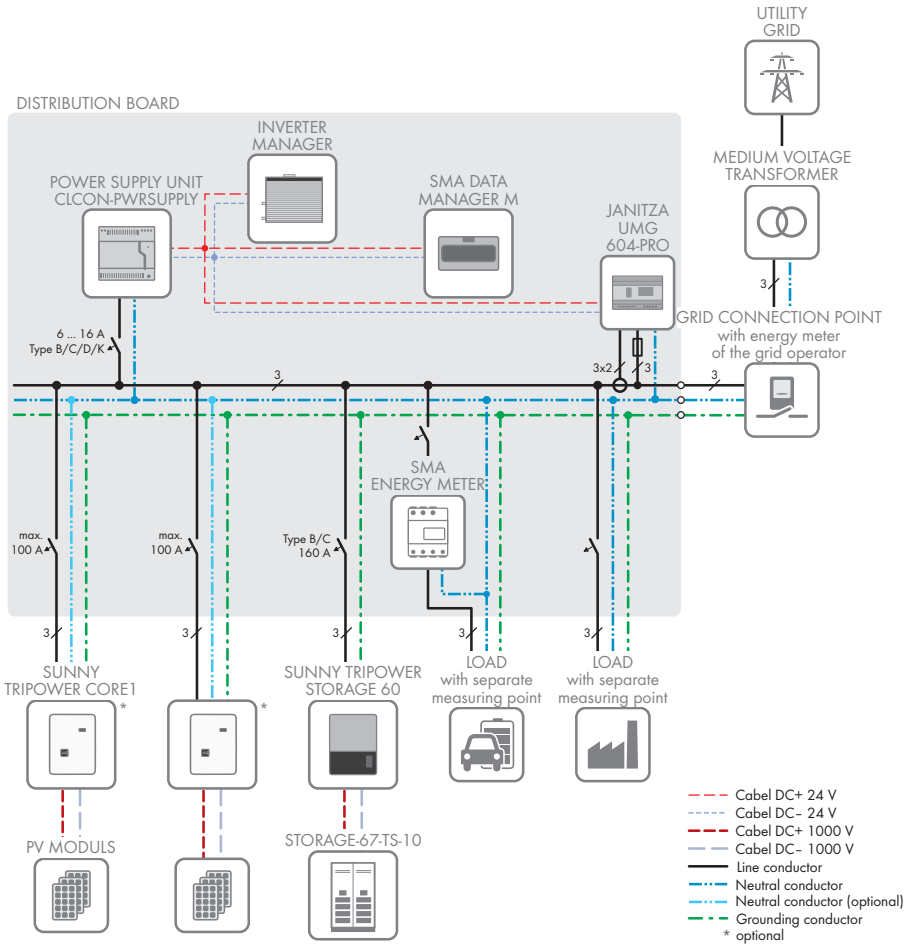

Figure 3: Circuitry overview of the overall system

## 4.2 Communication Overview

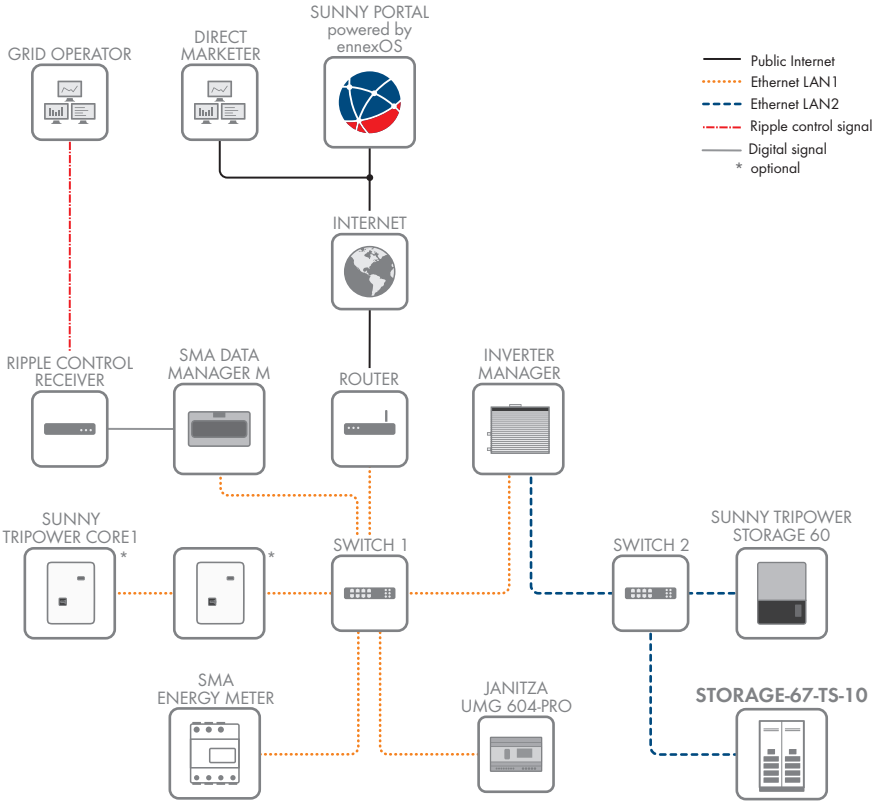

Figure 4: Design of system communication

## 5 Installation

### 5.1 Requirements for the Installation

#### Additionally required material (not included in the scope of delivery):

- Distribution board with required electric equipment
- For the Janitza UMG 604-PRO: three current transformers and, if needed, three voltage converters
- For the SMA Energy Meter: one or three current transformer(s) (depending on the electric circuit design)
- One router for the connection to the Internet. SMA Solar Technology AG recommends using an Internet flat rate.
- One terminal block with sufficient terminals for the voltage supply with 24 V DC of three devices
- Network cables
- For the receipt of ripple control signals: signal source (e.g. ripple control receiver or remote terminal unit) with up to four potential-free contacts. The signal source must be technically suitable for connection to the digital inputs of the SMA Data Manager.

#### Router requirements:

- DHCP should be supported (if possible with MAC address binding). Despite DHCP, SMA Solar Technology AG recommends manually assigning an IP address to each device from the address range of the router.
- TCP ports 123, 443 and 9524 must be authorized for outgoing connections.
- Fast Ethernet with 100 Mbit/s data transfer rate
- IGMP protocol version 2 or version 3 (IGMPv2 or IGMPv3) must be supported.
- The IPv4 protocol must be used at least in the internal network. The IPv6 protocol may be active in parallel.

#### Network cable requirements:

The cable length and quality affect the quality of the signal. Observe the following cable requirements.

- Cable type: 100BaseTx
- Cable category: minimum CAT5e
- Plug type: RJ45 of Cat5, Cat5e or higher
- Shielding: SF/UTP, S/UTP, SF/FTP or S/FTP
- Number of insulated conductor pairs and insulated conductor cross-section: at least 2 x 2 x 0.22 mm<sup>2</sup>
- Maximum cable length between two nodes when using patch cables: 50 m
- Maximum cable length between two nodes when using installation cables: 100 m
- UV-resistant for outdoor use.

**Signal cable requirements:**

The cable length and quality affect the quality of the signal. Observe the following cable requirements:

- Number of wires: at least 2
- Conductor cross-section: 0.2 mm<sup>2</sup> to 1.5 mm<sup>2</sup>
- Maximum cable length: 30 m
- UV-resistant for outdoor use

**Other requirements:**

- The distribution board is installed.
- The router is installed.
- The network switches are installed. The network switches are part of the battery delivery.

## 5.2 Installation Procedure

This section describes the procedure for the installation and gives an overview of the steps, which must always be performed in the prescribed sequence.

Procedure	See
1. Install the power supply unit.	Section 5.3, page 16
2. Install the SMA Inverter Manager.	Section 5.4, page 16
3. Install the Janitza UMG 604-PRO.	Section 5.5, page 17
4. Install the SMA Energy Meter.	Section 5.6, page 17
5. Install the SMA Data Manager.	Section 5.7, page 17
6. Install the battery.	Section 5.8, page 17
7. Install the battery inverter.	Section 5.9, page 17
8. Connect the DC cables to the battery.	Section 5.10, page 18
9. Install the PV inverters (optional).	Section 5.11, page 18

## 5.3 Installing the Power Supply Unit

1. Mount the power supply unit in the distribution board. The distribution board must be provided on site.
2. Connect the AC.
3. Connect the distribution terminal for the supply voltage of 24 V DC for the SMA Inverter Manager, the SMA Data Manager and the Janitza UMG 604-PRO. The distribution terminal must be provided on site.

## 5.4 Installing the SMA Inverter Manager

1. Mount the SMA Inverter Manager in the distribution board and connect the voltage supply.



2. Connect the LAN1 of the Inverter Manager to network switch 1 using a network cable
3. Connect the LAN2 of the Inverter Manager to network switch 2 using a network cable

## 5.5 Installing the Janitza UMB 604-PRO

1. Install the Janitza UMG 604-PRO in the distribution board in front of the point of interconnection.
2. Connect the voltage supply.
3. Connect suitable voltage converters and current transformers if needed. The current and voltage converters must be provided on site.
4. Connect the Janitza UMG 604-PRO to network switch 1 using a network cable.

## 5.6 Installing the SMA Energy Meter

1. Install the SMA Energy Meter in the distribution board in the electric circuit that is to be captured by the SMA Data Manager as the customer-specific measuring point. In a single-phase electric circuit, connect the line conductor L1 and the neutral conductor.
  2. Connect the SMA Energy Meter to network switch 1 using a network cable.
- The LEDs of the Energy Meter glow during start-up. The Energy Meter automatically connects to the SMA Data Manager.

## 5.7 Installing the SMA Data Manager

1. Mount the SMA Data Manager in the distribution board and connect the voltage supply.
2. Connect digital signal source (e.g. ripple control receiver) if necessary.
  - The start-up process begins. The SMA Data Manager is in operation when the system LED glows green.
3. Connect the SMA Data Manager to network switch 1 using a network cable.

## 5.8 Installing the Battery

1. Mount the battery cabinet.
2. If available, mount the extension kit for the battery-storage system (Storage Extension Kit TV-10).
3. Install all necessary parts and connect with each other inside the cabinet.
4. If available, mount the Battery Storage Combiner TV-10 and connect.
5. Route the DC cables from the battery cabinet to the Sunny Tripower Storage, but do not connect them to the battery yet. The DC cables must first be connected to the Sunny Tripower Storage and only then to the battery.
6. Connect the battery management system to network switch 2 using a network cable.

## 5.9 Installing the Battery Inverter

1. Mount the Sunny Tripower Storage and make the electrical connections.
2. Connect the Sunny Tripower Storage to network switch 2 using a network cable.

## 5.10 Connecting DC Cables to the Battery

- Connect the DC cables to the terminals **CHARGER**.

## 5.11 Installing the PV Inverter (optional)

1. Mount the PV inverters and make the electrical connections.
2. Connect the PV inverters with each other in line topology using a network cable. Connect the first or last PV inverter in the line to network switch 1 using a network cable.

## 6 Commissioning

### 6.1 Information on Commissioning Support and Warranty

#### Commissioning support:

A commissioning support is included in the system. You have the option of receiving on-site or telephone support for commissioning of SMA Solar Technology AG.

If you would like to use the support, contact Service (see Section 7, page 28). For the commissioning support on site, you will receive an order form from SMA Solar Technology AG. Fill out the order form and send it to [Systempackage@SMA.de](mailto:Systempackage@SMA.de). After receipt of the order form, you will receive an appointment confirmation from SMA Solar Technology AG.

#### Warranty:

In order to obtain the system warranty of ten years, the commissioning report for the system must be completed in Excel and e-mailed to [EnergySystem-Commissioning-Reports@SMA.de](mailto:EnergySystem-Commissioning-Reports@SMA.de) as an Excel file. To complete the commissioning report, you will need the serial numbers of all components in the system. The commissioning report can be found in the download area at [www.SMA-Solar.com](http://www.SMA-Solar.com).

### 6.2 Commissioning Procedure

This section describes the commissioning procedure and gives an overview of the steps you must always perform in the prescribed order.

#### Configuration of the overall system

The SMA Inverter Manager is the device for the configuration of the storage system via the LCS-Tool. The SMA Data Manager is the superordinate unit for the configuration of the overall system.

- Only configure the storage system via the SMA Inverter Manager. Use the LCS-Tool for this.
- After commissioning, the parameters of the PV inverters and of the SMA Data Manager can be adjusted via the Sunny Portal powered by ennexOS. The parameters of the batter inverter can be set via the LCS-Tool.

Procedure	See
1. Configure the Janitza UMG 604-PRO.	Section 6.3, page 20
2. Commission the battery inverter.	Section 6.4, page 20
3. Commission the battery.	Section 6.5, page 20
4. Commission the PV inverters (optional).	Section 6.6, page 20

Procedure	See
5. Configure the storage system with the LCS-Tool. <ul style="list-style-type: none"> <li>• Carry out the main configuration.</li> <li>• Capture the Janitza UMG 604-PRO.</li> <li>• Set the peak load shaving function.</li> <li>• Set the time of use.</li> </ul>	Section 6.7, page 21
6. Configure the overall system with the SMA Data Manager.	Section 6.8, page 25
7. Register the system in Sunny Portal powered by ennexOS.	Section 6.9, page 26
8. Deactivate the Webconnect function of the PV inverters	Section 6.10, page 26
9. For direct selling with SMA SPOT: configure SMA SPOT in Sunny Portal powered by ennexOS.	Section 6.11, page 27
10. Complete the commissioning report.	Section 6.12, page 27

### 6.3 Configuring the Janitza UMG 604-PRO

- Switch on the fuse.
  - The display becomes active and the start-up process begins.
- Select the programming mode on the device.
- Set the current and voltage converter ratio.
- Configure the Ethernet connection. While doing so, the device must be configured as **DHCP client**.

### 6.4 Commissioning the Battery Inverter

- Turn the DC load-break switch to **ON**.
- Switch on the AC circuit breaker.
  - The LED **On** glows green and the display starts. As soon as the display shows something, the LED **On** briefly goes out and then flashes quickly. The display shows the message **PV off** and the LED **On** is off.

### 6.5 Commissioning the Battery

- Switch on the switch **SWITCH**.
- The display becomes active and the start-up process begins. The LED is flashing green.
- The display is showing values and the LED is glowing green. The start procedure is complete.
- The display of the battery inverter is showing values and the LED **On** is glowing green.

### 6.6 Commissioning the PV Inverter (optional)

Once the PV inverters have been installed, commission each PV inverter as described in the following.

**Procedure:**

1. Turn the DC load-break switch to **ON**.
2. Switch on the AC circuit breaker.
- ☑ All three LEDs light up. The start-up phase begins. All three LEDs go out again after approximately 90 seconds.
- ☑ Depending on the available power, the green LED pulses or is continuously illuminated. The inverter is feeding in.

## 6.7 Configuration of the storage system with LCS-Tool

### 6.7.1 Making the Main Configuration

The LCS-Tool is the software for the storage system. The storage system is configured via the LCS-Tool. The installation file is stored on the USB flash drive that is contained in the battery delivery or you can download the software at [www.SMA-Solar.com](http://www.SMA-Solar.com).

#### **i** Optional: enable Peak Load Shaving or Time of Use

Either the Peak Load Shaving function or the Time of Use can be enabled as required. It is not possible to enable both functions simultaneously.

**Procedure:**

1. Install the LCS-Tool on an end device.
2. Launch the LCS-Tool.
3. If only the STORAGE-67-TS-10 was installed, from the drop-down list **Type of battery**: select the entry **TESVOLT TS HV - 14 Modules** and, if needed, adjust the limits under **Pre-Set Battery Limits**.
4. If the STORAGE-67-TS-10 and the Storage Extension Kit TV-10 were installed, from the drop-down list **Type of battery**: select the entry **TESVOLT TS HV - 16 Modules** and, if needed, adjust the limits **Pre-Set Battery Limits**.
5. If Peak Load Shaving is to be active, in the menu **Power Management** set the drop-down list **Peak Load Shaving** to **On**. Adjust the parameter for Peak Load Shaving if needed.
6. If Time of Use is to be active, in the menu **Power Management** set the drop-down list **Time Of Use** to **On**. Adjust the parameters for Time of Use if needed.
7. Select [**Next**].
8. In the field **Battery IP** enter the IP address of the battery management system and select [**Connect**]. The IP address can be found on the display of the battery. After the battery management system has been connected, the software version and the serial number of the battery management system are displayed.
9. Select [**Next**].
10. Enter the system data on the page **Plant details (optional)**. This step is not mandatory.
11. Select [**Next**].
12. Make the country settings:
  - In the drop-down list **Select Country** select the country in which the storage system is installed.

- In the drop-down list **Select Grid Code** select the entry **Germany\_MV**.
- In the drop-down list **Confirm Grid Code** select the entry **Germany\_MV**.

13. Select **[Next]**. A summary of your settings is displayed. The main configuration is complete and the values are transmitted to the battery inverter.

## 6.7.2 Capturing the Janitza UMG 604-PRO

1. Select the menu **Setup > Limited Export**.
2. Enter all the data of the Janitza UMG 604-PRO. This is necessary so that the SMA Inverter Manager can control the storage system according to the data of the power analyzer.
3. Save all settings and close the LCS-Tool.

## 6.7.3 Setting the Peak Load Shaving Function (optional)

### **i** Input values for Peak Load Shaving

The value **Consumption Limit** specifies the maximum power that may be obtained from the utility grid. If this power is exceeded, the storage system discharges to cut the peak load. The value **Feed in Limit** specifies the power from which the storage system recharges. This value depends on the peak loads to be expected and must be adapted to the application during planning and commissioning.

The input value for **Consumption Limit** is interpreted by the SMA Inverter Manager as a positive value and the one for **Feed-in Limit** as a negative value.

If the SMA Inverter Manager, for example, has to limit the grid reference power to +50 kW and charge the battery below a grid reference power of +10 kW, the value **50** must be entered for **Consumption Limit** and the value **-10** for **Feed-in Limit**.

In order for the peak load shaving to work, the following conditions must be observed when designing the values:

- The peak load to be cut **dP** must not be greater than the output power of the battery inverter.
- The energy of the peak load **D** must not be greater than the capacity of the battery.
- The charging energy **C** must be slightly greater than the discharging energy **D**.
- In case of significant changes in the load or generation profile, the parameters must be adjusted accordingly.

### **i** FNN Note

In Germany, according to FNN note "Connecting and operating storage units in low voltage networks" (October 2016), systems eligible under the FIT scheme in accordance with EEG and KWKG are not allowed to feed energy from storage units into the utility grid. To ensure this, the input value for **Consumption Limit** is not allowed to be negative.

**Consumption Limit**

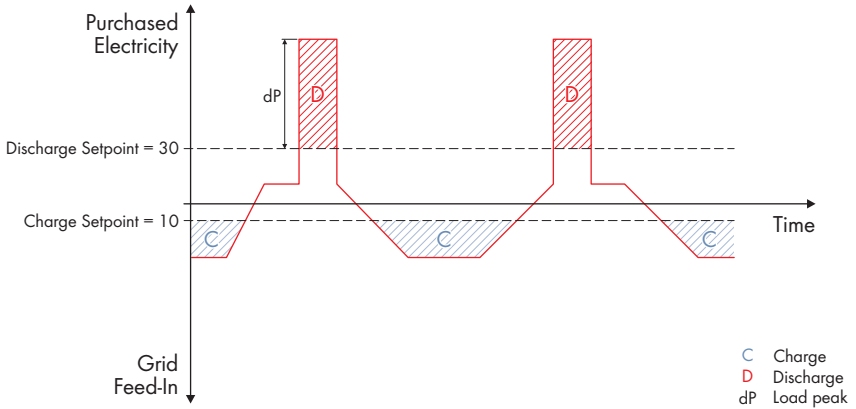

Figure 5: Battery is charged from local generation

**Feed-In Limit**

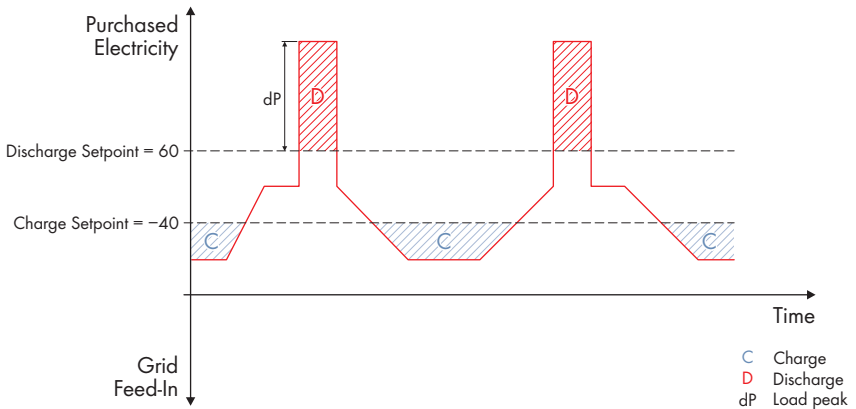

Figure 6: Battery is charged from the utility grid

**Procedure:**

1. Select the menu **Setup**.
2. In the menu **Power Management** enable the function **Peak Load Shaving**. Otherwise, the **Time of Use** function could be used.
3. Under **Peak Load Shaving** enter the value for **Consumption Limit** and **Feed in Limit** under **Peak Load Shaving**.

4. Enter all the data of the Janitza UMG 604-PRO.  
This is necessary so that the SMA Inverter Manager can control the storage system according to the data of the power analyzer.

Meter IP-Address:	<input type="text" value="172.16.1.77"/>
Meter Modbus Port:	<input type="text" value="502"/>
Meter Modbus Unit ID:	<input type="text" value="1"/>
Meter Power Modbus Register:	<input type="text" value="18026"/>
Meter Reactive Power Modbus Register:	<input type="text" value="18028"/>
Meter Voltage Modbus Register:	<input type="text" value="18006"/>
Meter Frequency Modbus Register:	<input type="text" value="18050"/>
Safety Offset:	<input type="text" value="0"/>
Meter Connection Timeout:	<input type="text" value="10"/>

### 6.7.4 Setting Time-of-Use (optional)

The function Time of Use allows the reduction of energy costs by effectively using different electricity tariffs throughout the day. For this, periods can be defined in the LCS-Tool during which the battery can be charged cost-effectively and periods during which the battery is discharged when the energy costs are high.

The battery can be charged up to 60 kW. In the standard configuration, the battery can be discharged with 60 kW. If the system is equipped with the Storage Extension Kit TV-10, the battery can be discharged with 75 kW.

#### Battery behavior during the charging period:

- The battery will be charged at the specified charging power. At night, the energy will be directly drawn from the utility grid. If there is unused PV energy available for charging the battery during the day, the missing energy will be drawn from the utility grid.
- Discharging and controlling the battery are blocked for the charging period.

#### Battery behavior during the discharging period:

- If power is drawn at the point of interconnection, the battery inverter attempts to compensate for this by discharging the battery.
- If excess PV power is being fed in at the point of interconnection, the battery inverter attempts to balance this by charging the battery.
- If the maximum charging power of the battery system has been exceeded during the discharging period, power is fed into the utility grid.
- If the maximum discharging power of the battery system has been exceeded, power is drawn from the utility grid. This power is not used to charge the batteries.



In order to optimally adapt the charging behavior to the different conditions over the course of the year, the settings can be made separately for two periods (**Season 1** and **Season 2**). For these periods, separate charging profiles can be defined for each day of the week. Settings for 30-minute intervals or for the entire day can be made.

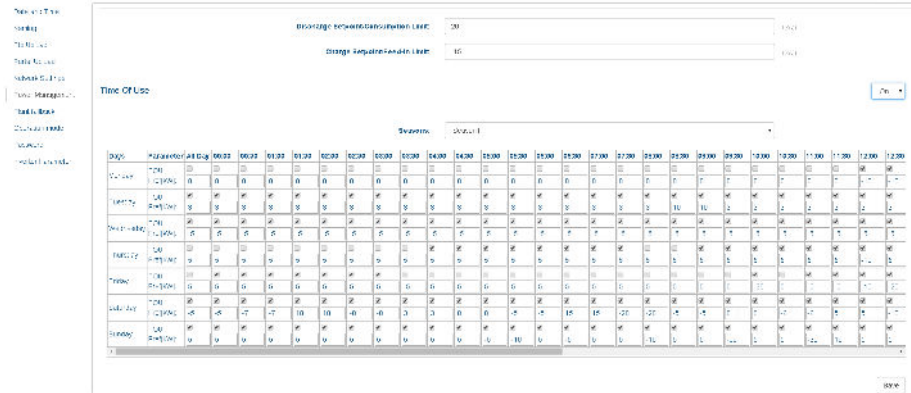

Figure 7: LCS Tool - setting Time of Use

**Procedure:**

1. Select the menu **Setup**.
2. In the **Inverter Parameter** menu in the **Immediate controls** area, make sure that the parameter **Active Power (P\_ref)** is set to **100%**.
3. Enable the **Time of Use** function in the **Power Management** menu. Otherwise, the Peak Load Shaving function could be used.
4. To define the time windows of both periods, select the period to be defined under **Seasons** and adjust the corresponding settings: To define the entire day with the same setting, select the field **All Day** of the corresponding day of the week. The same setting is valid for the power throughout the day. To make settings for the individual periods, select the desired periods of the corresponding day of the week.
5. Select the period to be used under **Seasons**.
6. Enter the power of the respective time interval. As a result, the battery is discharged (Feed in), if needed, at values with a positive sign (+), and charged (Charge) at values with a negative sign (-).
7. Select **[Save]** to save the changes.

## 6.8 Configuring the Overall System with the SMA Data Manager

1. Open the user interface of the SMA Data Manager and start the installation assistant.
2. Register the Speedwire devices (all PV inverters). Chose a system password. The system password is not transmitted to the SMA Energy Meter, the storage system and the Janitza UMG 604-PRO.

3. Register Modbus devices (Sunny Tripower Storage and Janitza UMG 604-PRO). While doing so, select the Modbus profile **Janitza Power Analyser UMG 604** for the Janitza UMG 604-PRO and for the storage system select the Modbus profile **STPS-60**.
4. Set the country standard. Select the button **[Yes]** and then the country standard:
  - For systems in compliance with the German Association of Energy and Water Industries (BDEW) medium-voltage directive with external decoupling protection, select the country standard **MVtgDirective**.
  - For systems in compliance with the German Association of Energy and Water Industries (BDEW) medium-voltage directive without external decoupling protection, select the country standard **MVtgDirectiveInt**.
  - For systems in accordance with the low voltage application rule select the country standard **VDE-AR-N4105-HP**.
- The country standard setting is transferred to the PV inverters automatically.
5. Configure the energy meters. The **Janitza Power Analyser UMG 604** must be configured as a central grid-supplied power and feed-in meter at the point of interconnection. The **SMA Energy Meter** must be configured as an energy meter for a customer-specific measuring point.
6. Disable the Modbus server for communication with the Modbus devices.
7. Select the type of control. Observe the specifications of the grid operator.
8. Set the grid management services. Observe the specifications of the grid operator.
9. For direct selling with SMA SPOT, under **Selection of the setpoint** enable the switch **Direct selling interface** and select **SMA SPOT**.
- The system LED of the SMA Data Manager is flashing green. A connection to all registered devices is established.

## 6.9 Registering the System in Sunny Portal powered by ennexOS

1. Register the system via the SMA Data Manager in the Sunny Portal powered by ennexOS: <https://ennexOS.SunnyPortal.com>. If the system was designed with Sunny Design, important system data can be exported to Sunny Portal powered by ennexOS via the Sunny Design file.
2. Activate Smart Connected. To do this, select **Yes, I would like to participate in the Smart Connected program with this performance description**. in the extended system properties.

## 6.10 Deactivating the Webconnect Function of the PV Inverters in Sunny Portal powered by ennexOS (optional)

Once the PV inverters have been installed, disable the Webconnect function of the PV inverters in Sunny Portal powered by ennexOS as described in the following:

### Procedure:

1. Select **Configuration > Device parameter adjustment**.

2. Select **System parameter assistant**.
3. Select all PV inverters.
4. Select [**Next**].
5. Select the parameter **External communication** and set to **No**.
6. Select [**Next**].
7. Click on [**Save**].

## 6.11 Configuring SMA SPOT in Sunny Portal powered by ennexOS (optional)

1. Select **Configuration > System properties**.
2. Activate the **SMA SPOT** switch and enter the data.

## 6.12 Completing the Commissioning Report

1. Download the commissioning report (Excel file) from the download area at [www.SMA-Solar.com](http://www.SMA-Solar.com).
  2. Complete the commissioning report (Excel file).
  3. E-mail the completed commissioning report to **EnergySystem-Commissioning-Reports@SMA.de** as an Excel file.
- Once the commissioning report has been received, the ten-year system warranty is activated and you will receive a corresponding confirmation.

## 7 Contact

If you have technical problems with our products, please contact the SMA Service Line. The following data is required in order to provide you with the necessary assistance:

- Inverters:
  - Device type
  - Serial number
  - Firmware version
  - Event message
  - Mounting location and mounting height
  - Type and number of PV modules
  - Detailed description of the problem
- Battery:
  - Type
  - Firmware version
- SMA Data Manager:
  - Device type
  - Serial number
  - Firmware version
  - Event message
  - Information on the ripple control receiver
- SMA Energy Meter:
  - Device type
  - Serial number
  - Firmware version
- SMA Inverter Manager:
  - Serial number
  - Firmware version
- Janitza UMG 604-PRO:
  - Serial number
- Sunny Portal
  - System name in Sunny Portal
  - Access data for Sunny Portal

United Kingdom            SMA Solar UK Ltd.  
Milton Keynes  
+44 1908 304899  
SMA Online Service Center: [www.SMA-Service.com](http://www.SMA-Service.com)

---

Deutschland                SMA Solar Technology AG  
Niestetal  
+49 561 9522-1510  
SMA Online Service Center: [www.SMA-Service.com](http://www.SMA-Service.com)

---

