

solaredge

SolarEdge Home Gateway Installation Guide

Version 1.4

Disclaimers

Important Notice

Copyright © SolarEdge Inc. All rights reserved.

No part of this document may be reproduced, stored in a retrieval system, or transmitted, in any form or by any means, electronic, mechanical, photographic, magnetic or otherwise, without the prior written permission of SolarEdge Inc.

This document is solely for the use of SolarEdge customers and employees.

The material furnished in this document is believed to be accurate and reliable. However, SolarEdge assumes no responsibility for the use of this material. SolarEdge reserves the right to make changes to the material at any time and without notice. You may refer to the SolarEdge web site (www.solaredge.com) for the most updated version.

All company and brand products and service names are trademarks or registered trademarks of their respective holders.

Patent marking notice: <http://www.solaredge.com/groups/patent>

The general terms and conditions of purchase of SolarEdge products shall apply.

The content of these documents is continually reviewed and amended, where necessary. However, discrepancies cannot be excluded. No guarantee is made for the completeness of these documents.



FCC Compliance

This equipment has been tested and found to comply with the limits for a Class B digital device, pursuant to part 15 of the FCC Rules. These limits are designed to provide reasonable protection against harmful interference in a residential installation. This equipment generates, uses and can radiate radio frequency energy and, if not installed and used in accordance with the instructions, may cause harmful interference to radio communications. However, there is no guarantee that interference will not occur in a particular installation. If this equipment does cause harmful interference to radio or television reception, which can be determined by turning the equipment OFF and ON, you are encouraged to try to correct the interference by one or more of the following measures:

- Reorient or relocate the receiving antenna.
- Increase the separation between the equipment and the receiver.
- Connect the equipment into an outlet on a circuit different from that to which the receiver is connected.
- Consult the dealer or an experienced radio/TV technician for help.

Changes or modifications not expressly approved by the party responsible for compliance may void the user's authority to operate the equipment.

Table of Contents

Disclaimers	1
Important Notice	1
FCC Compliance	2
Table of Contents	3
About This Guide	5
Support and Contact Information	7
Chapter 1: Introducing the Home Gateway	8
Overview.....	8
Package Contents	10
Installation Procedure	10
Chapter 2: Home Gateway User Interfaces	11
Connectors.....	12
DIP Switches	12
Configuration Button	12
LEDs	12
Chapter 3: Installing the SolarEdge Home Gateway	14
Installation Guidelines	14
Connecting the SolarEdge Gateway.....	16
Device Discovery.....	16
Verifying the Connection	17
Appendix A: Troubleshooting	18
Troubleshooting Ethernet Connection	18
Troubleshooting ZigBee Wireless Connection	20
Yellow LED (Link) does not blink after device discovery.....	20
Yellow LED (Link) does not blink according to no. of Slaves	20

Appendix B: Configuring the Home Gateway	22
Connecting to the Home Gateway via the SolarEdge Configuration Tool	23
Disabling the DHCP and Configuring the IP Settings	25
Appendix C: Technical Specifications	26

About This Guide

This user guide is intended for Photovoltaic (PV) system owners, installers, technicians, maintainers, and integrators who use the SolarEdge power harvesting system.

This manual describes how to install and set up ZigBee™ communication between a SolarEdge device (inverters or Safety and Monitoring Interface) and the SolarEdge home gateway (also referred to as SolarEdge gateway). The manual instructions and graphics refer to the inverter; however apply to SMI as well.

This guide assumes that the SolarEdge power harvesting system is already installed and commissioned. For additional information about how to install and commission the SolarEdge power harvesting system, refer to the relevant installation guide.

The guide includes the following chapters:

- **Chapter 1: Introducing the Home Gateway**, page 8, describes the SolarEdge home gateway functionality and connection.
- **Chapter 2: Home Gateway User Interfaces**, page 11, describes the home gateway connectors, configuration button, and LEDs.
- **Chapter 3: Installing the SolarEdge Home Gateway**, page 14, describes how to mount, connect and verify the connection of the SolarEdge home gateway.
- **Appendix A: Troubleshooting**, page 18, describes connection and communication problems, and how to troubleshoot them
- **Appendix B: Configuring the Home Gateway**, page 22, describes how to use the SolarEdge configuration tool for checking the home gateway settings and setting a static IP to the home gateway, instead of automatic DHCP, if necessary.
- **Appendix C: Technical Specifications**, page 26, provides the electrical and mechanical specifications of the SolarEdge home gateway device.

For further information, datasheets and the most up-to-date certifications for various products in different countries, please visit the SolarEdge website: www.solaredge.com

Support and Contact Information

If you have technical queries concerning our products, please contact us:

Australia	1800 465 567	support@solaredge.net.au
APAC (Asia Pacific)		support-asia@solaredge.com
Belgium	080073041	support@solaredge.be
France	0800917410	support@solaredge.fr
Germany	+49 89-45459730	support@solaredge.de
Italy	800 784 824	support@solaredge.it
Japan	+81.3.5530.9360	support@solaredge.jp
United Kingdom	0800 028 1183	support@solaredge.uk
US & Canada	1 877 360 5292	ussupport@solaredge.com
Greece	00800125574	
Israel	+972 73 240-3118	
Netherlands	08000221089	support@solaredge.com
Worldwide	+972 73 240-3118	
Fax	+972 73 240-3117	

Before contacting SolarEdge, ensure you have the product serial number as appears on its label.



Chapter 1: Introducing the Home Gateway

Overview

The SolarEdge home gateway is used for wireless connectivity between one or more inverters at a site and a remote internet gateway point. Wireless connectivity allows simplifying the installations as no outdoor cabling is required. The SolarEdge home gateway communicates using ZigBee, a standard for low-rate, high-reliability, and multi device wireless protocol for telemetry communications.

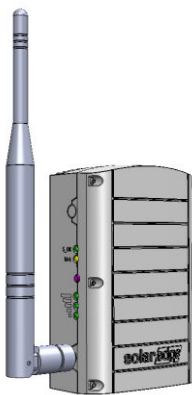

Figure 1: The SolarEdge Home Gateway

Figure 2 shows an inverter as an example; however, this illustration is applicable to other SolarEdge devices, such as Safety and Monitoring Interface (SMI).



Figure 2: Connection to the SolarEdge Inverter

The home gateway is provided with one slave unit that is installed inside the inverter. Up to 15 SolarEdge inverters can be supported per one ZigBee wireless link. In order to enable more than one inverter, additional slave kits are required (sold separately).



Figure 3: Connection to a Multiple Inverter Wireless Bus

Package Contents

- Home gateway with antenna
- Power supply
- CAT 5E Ethernet cable
- ZigBee slave kit, including:
 - ZigBee slave module
 - Antenna with RF cable
 - Mounting bracket clip for installing the antenna on the inverter
 - Installation guide
- This installation guide

Installation Procedure

The following illustrates the steps required for the home gateway installation:

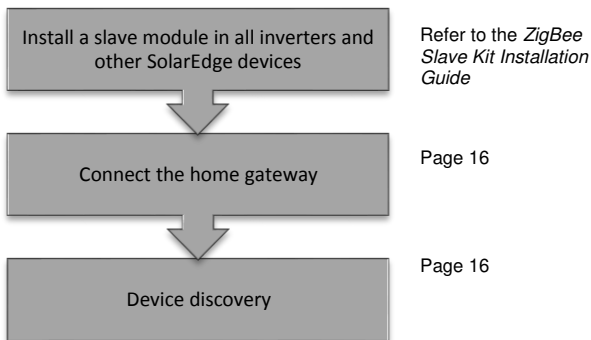

Chapter 2: Home Gateway User Interfaces

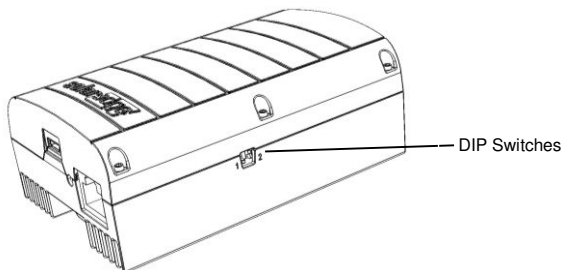
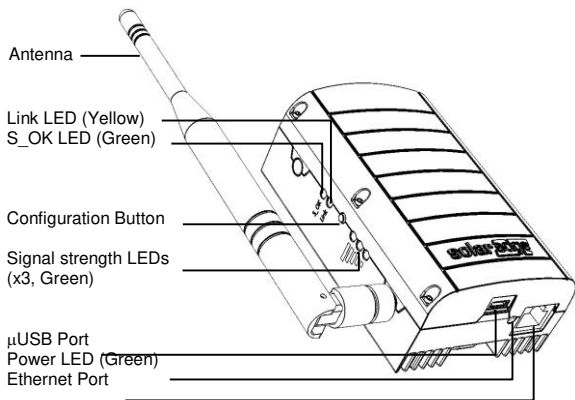

Figure 4: SolarEdge Home Gateway Interfaces

Connectors

- **µUSB:** Connection to the power supply. This port can also be used for connecting to a computer for advanced configuration or SW upgrade.
- **Ethernet:** Connecting the SolarEdge gateway to the SolarEdge monitoring portal through an Ethernet switch/router. The Ethernet switch/router should be connected to the Internet.

DIP Switches

Two DIP switches are located at the side of the gateway. They are used for internal configuration; therefore, their position should not be changed.

Configuration Button

The configuration button is used for the following:

- Discovery of slave devices and associating them to the home gateway
- Diagnosis of communication problems



To use the configuration button:

- Short press: Pressing the configuration button for 5-10 seconds and releasing it - discover slaves (device discovery)
- Long press: Pressing the configuration button for more than 10 seconds and releasing it - start diagnostics mode (refer to *Appendix A: Troubleshooting* on page 18).

LEDs

The gateway has four LED indicators, as follows:

Label and Color	Indication	Functionality ¹
S_OK (green)	Connection with the SolarEdge monitoring portal	ON - Connection with SolarEdge monitoring portal is OK OFF - Communication with the SolarEdge monitoring portal failed
Link (yellow)	Communication with associated slave(s)	Blinking - There has been ZigBee communication in the last 15 minutes. The LED blinks according to the number of slaves as follows: for each slave 0.5 sec. ON and 0.5 sec. OFF. This is repeated following a 5 sec. pause. OFF - No communication with any slave in the last 15min
3x Signal strength (RSSI) (green)	Received Signal Strength Indication - Low/Medium/High	All 3 LEDs ON - High Two LEDs ON - Medium One LED ON - Low
Power (green)	Power	Power supply connected to the home gateway

¹ Functionality during normal operation. during device discovery and diagnostic mode, the LEDs indicate different functionality (see *Appendix A: Troubleshooting*)

Chapter 3: Installing the SolarEdge Home Gateway

Installation Guidelines

The following requirements apply when locating and mounting the SolarEdge gateway:

- The SolarEdge home gateway is suitable for mounting indoors only. For outdoor installation, use an external plastic outdoor enclosure (not provided by SolarEdge)
- The SolarEdge home gateway must always remain in an ambient temperature of -20°C (-4°F) to $+60^{\circ}\text{C}$ (140°F).
- Protect the SolarEdge home gateway from dust, wet conditions, corrosive substances, and vapors.
- Install the SolarEdge home gateway on a wall or place it on the desk.

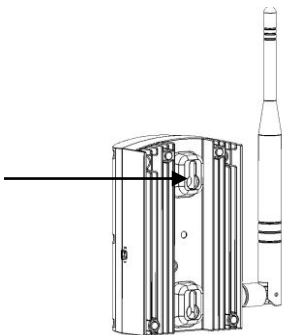

Figure 5: Wall Mount Option

- Ensure that the antenna is always vertically oriented.

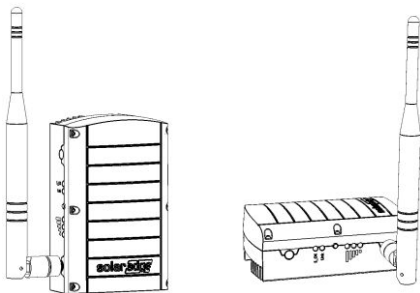

Figure 6: Antenna Orientation

Connecting the SolarEdge Gateway

- 1** Install the supplied ZigBee slave module in the slave device (inverters or SMI) as described in the *ZigBee Slave Kit Installation Guide*. To connect more slaves, purchase an additional ZigBee slave kit for each slave device (sold separately).
- 2** Connect the power supply to the μ USB connector and connect to an AC source. The power LED is lit to indicate power connection.
- 3** Connect the Ethernet cable between the gateway connector and the router or switch used to connect to the Internet.

Device Discovery

Press the configuration button on the home gateway for 5-10 seconds and release. Release the button after all LEDs have turned on. The gateway starts discovering the slave device(s). The device discovery may take 2-3 minutes, during which all the LEDs blink. The signal strength LEDs also light up (refer to *LEDs* on page 13).

Verifying the Connection

- 1 Verify that the S_OK LED is ON, which indicates the communication with the SolarEdge portal is established. This may take up to five minutes. If the LED does not light up, refer to *Appendix A: Troubleshooting* on page 18.
- 2 After device discovery, verify that the yellow (Link) LED blinks and indicates the correct amount of slaves, as described in the following illustration.

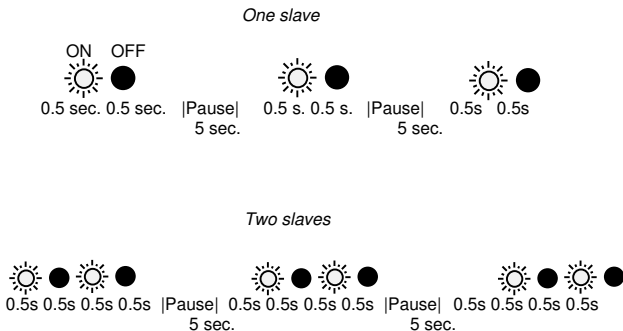

Figure 7: Example of LED Blinks for One or Two Slaves

- 3 Verify signal strength: Check that at least two RSSI LEDs are ON, which indicates medium signal strength. If only one LED is ON, the signal strength is Low. Consider relocating the home gateway closer to the inverter to improve reception. If all RSSI LEDs are OFF, place a SolarEdge ZigBee repeater (sold separately) between the home gateway and the inverter. Refer also to *Troubleshooting Ethernet Connection*, below.

Appendix A: Troubleshooting

Troubleshooting Ethernet Connection

If the S_OK LED on the gateway is not ON, use the diagnostics mode to identify the error:

Press the gateway configuration button for more than 10 seconds and release it (after all LED turn on and then off while pressing). The home gateway is now in diagnostics mode.

- If all LEDs light up – no error has occurred.
- If one of the LEDs is OFF, refer to the following table to diagnose the problem. If more than one problem is identified, diagnose the top one first

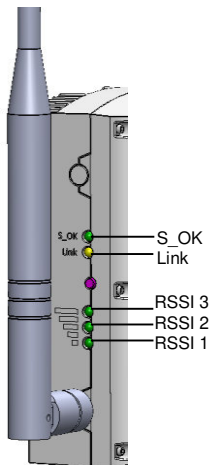

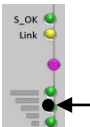
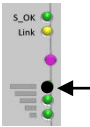
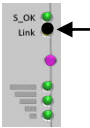
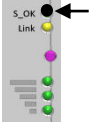

Figure 8: Home Gateway LEDs

Label and Color	Indication when OFF During diagnostic mode	Troubleshooting	
RSSI 1 (Low, green)		An Ethernet physical cable connection fault: The Ethernet link or physical Ethernet cable are not connected properly	Check the cable pin-out assignment and cable connection
RSSI 2 (Medium, green)		The gateway failed to get a valid IP address from the DHCP server, or The DHCP/static IP settings in the gateway are not the same as those of the router.	Refer to <i>Appendix B: Configuring the Home Gateway</i> on page 22
RSSI 3 (High, green)		The connection to the router is not available: Ping to the first local switch/router failed (LAN error)	Check the physical connection to the switch/router. contact your network IT, otherwise replace the cable or change it from cross to straight connection
Link (yellow)		The connection to the Internet is not available: Ping to google.com failed	Connect a laptop and use the configuration tool to check for internet connection. If internet access is unavailable, contact your IT admin or your internet provider.
S_OK (green)		The connection to the SolarEdge portal was not established: Communication with the portal failed	Check the SolarEdge server address using the configuration tool (refer to <i>Appendix B: Configuring the Home Gateway</i> on page 22)

Troubleshooting ZigBee Wireless Connection

Yellow LED (Link) does not blink after device discovery

If the yellow LED (Link) does not blink after device discovery, a connection error may have occurred. Try the following troubleshooting actions:

- Relocate the home gateway closer to the inverter to improve signal strength.
- Disconnect the inverter from the AC source and check that the ZigBee slave inside the inverter is in the correct orientation and that all its pins are inserted into their correct locations in the communication board, and no pins are left out of their socket.
- Place a SolarEdge repeater (sold separately) between the home gateway and the inverter. Refer to the *SolarEdge Repeater Installation Guide*.

Yellow LED (Link) does not blink according to no. of Slaves

If the yellow LED does blink, however not the correct number of times (according to number of slaves), try the following troubleshooting actions:

- 1 Check the inverters as follows in order to identify a disconnected inverter:
 - a. Short-press the inverter's LCD light button until reaching the *Server* status screen:

```
S e r v e r :   Z i g b e e   < S _ O K >
S t a t u s           < O K >
```

- b. Check that **S_OK** appears in the Server field to indicate a functioning connection to the SolarEdge monitoring portal, which was validated during the last two minutes. Check that the **<OK>** appears in the Status field.

If **S_OK** is not displayed, or **Gateway Not Found / Master Not Found** appear, then this is the slave not detected. Do the following:

- Check that the ZigBee slave inside the inverter is in the correct orientation and that all its pins are inserted into their correct locations in the communication board, and no pins are left out of their socket.
- Reload ZigBee defaults as described in the *ZigBee Slave Kit Installation Guide*.

- 2 Short-press the inverter's LCD light button until reaching the *ZigBee* status screen:

```
P A N   I D : 0 0 0 0 0 0 1 A B 7
C H :   1 5 / 1 F F E   R S S I :   < M >
I D :   0 0 1 3 A 2 0 0 4 0 4 9 B 2
M I D   : 0 0 1 3 A 2 0 0 4 0 9 2 0 3 3 6
```

- 3 Check the following:
 - **MID**: check that an MID (Master ID) value appears, to indicate the identification number of the home gateway. If **ZigBee Ready** appears, the inverter is not associated with the home gateway. Perform device discovery.
- 4 **RSSI**: check that **H** (High) or **M** (Medium) appears which indicates the signal strength. If **L** (Low) or no values appear, relocate the gateway for better signal reception, or use a repeater.

Appendix B: Configuring the Home Gateway

This procedure describes how to configure the home gateway to work with a static IP instead of automatic DHCP. **When using standard automatic DHCP routers, this step is not required.** Change the IP settings only when the router/server is set to static IP mode and as part of troubleshooting the Ethernet (*Troubleshooting Ethernet Connection* on page 18).

To configure the home gateway communication, use the SolarEdge configuration tool, as described below. The configuration tool is a software application that enables to configure SolarEdge specific parameters and to display and troubleshoot site-specific issues. The application provides a standard Windows GUI that can be accessed by connecting a computer or laptop to the home gateway through its μ USB port.

When connecting the home gateway to a PC, no other USB devices should be connected to the same USB port using a USB splitter.

Connecting to the Home Gateway via the SolarEdge Configuration Tool

- 1 Download and install the configuration tool as described in its manual.
- 2 Disconnect the home gateway from the AC source and connect it using a USB cable to the PC/laptop that has the configuration tool installed.
- 3 Double-click on the configuration tool icon. The SolarEdge configuration tool main window is displayed (with the Connect to SolarEdge product window).

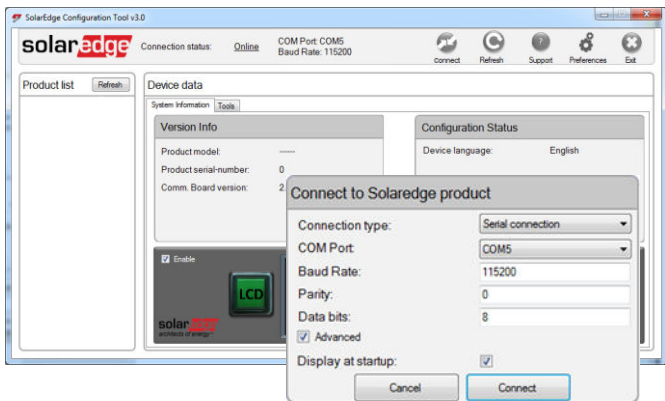

Figure 9: Configuration Tool

- If the **Connect to SolarEdge product** window does not appear at startup, click **Connect** in the main window.
- In the **Connect to SolarEdge product** window, select the correct COM and click **Connect**. The home gateway configuration can now be viewed and edited, using the four buttons at the bottom-right of the screen, or the LCD button at the bottom left.

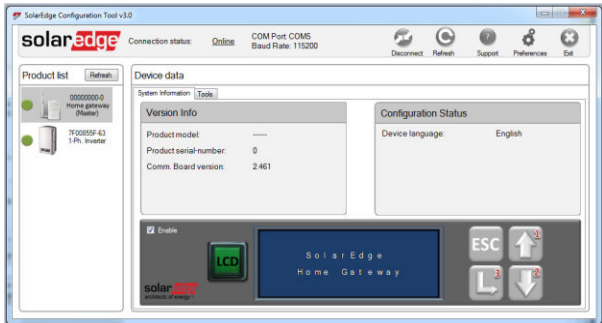

Figure 10: Configuration Tool Showing Connection to Home Gateway

- Long press the LCD button until the Long bar at the right site is fully colored.



Figure 11: Configuration Tool Showing Long-press Bar

- Click the buttons on the right to enter the password: 12312312.

Disabling the DHCP and Configuring the IP Settings

- 1 Use the up and down arrows to scroll to the **Communication** menu. Press Enter to select it. The following menu is displayed:

```
S e r v e r < L A N >
L A N   C o n f
R S 4 8 5 - 1   C o n f < S >
Z i g B e e   C o n f < S >
R S 2 3 2   C o n f
```

- 2 Select **LAN Conf**. The following menu is displayed:

```
I P   C o n f i g
S e t   D H C P   < e n >
S e t   I P
S e t   M a s k
S e t   G a t e w a y
S e t   D N S
S e t   S e r v e r   A d d r
S e t   S e r v e r   P o r t
```

- 3 Select **Set DHCP** and set it to Disabled.
- 4 Click the Enter button to apply this setting.
- 5 Under the **LAN Conf** menu, set the following parameters according to your network properties. These values can be obtained from the network IT manager:
 - To set the IP address, select **Set IP**
 - To set the Subnet Mask select **Set Mask**
 - To set the Default Gateway select **Set Gateway**
 - To set the DNS servers select **Set DNS**
- 6 Exit the menu.

Appendix C: Technical Specifications

	North America	Worldwide	Unit
Functional			
Number of inverters that can be monitored	1-15		
Performance			
Transmit power	18	10	dBm
Receiver Sensitivity	-102		dBm
EIRP with Antenna	22	14	dBm
Outdoor (LOS) range	400/1300		m/ft
Indoor range ¹	50/160		m/ft
Environmental			
Operating temperature	-20 ÷ +60		°C
Storage temperature	-20 ÷ +60		°C
Relative humidity (non condensing)	0 ÷ 80		%
Ingress protection	IP20		
Power Supply Requirements			
Voltage	5		V
Current	1		A

¹ Approximate values, may differ depending on specific installation conditions

If you have technical queries concerning our products, please contact our support through SolarEdge service portal:

<http://www.solaredge.com/groups/support/services>

North America	(Toll free) 1877 360 529 2
Australia	(Toll free) 1800 46 55 67
Germany	089 454 597 30
France	(Toll free) 0800 917 410
Italy	(Toll free) 800 784 824
Japan	(Toll free) +81.3.5530.9360
United Kingdom	(Toll free) 0800 028 1183
Belgium	(Toll free) 0800 730 41
Israel	073 240 311 8
Rest of world	+ 1 (0) 650 319 884 3
Fax	+ 972 (0) 73 240 311 7
Email to:	support@solaredge.com

www.solaredge.com

solaredge



MAN-01-00118-1.4